

Please go to [www.quoise.com](http://www.quoise.com) for product cleaning tips. Go to the **Care + Maintenance** selection.

**Tools Required:** Flathead screwdriver, Phillips screwdriver, pliers, gloves, safety glasses.

**Estimated Assembly Time:** 20-30 minutes

**Preparation:** Identify and inspect all parts before beginning installation. Check package content list and diagrams below to be sure all parts are present. If any parts are missing or damaged, do not attempt to assemble, install, or operate the mirror. Contact customer service for replacement parts.

### ⚠ Warnings and Cautions

These instructions are provided for your safety. It is very important you read them completely before installing the mirror. We strongly recommend that a licensed, professional electrician perform the installation. Quoizel recommends 2 people for each step during assembly.

### Package Contents

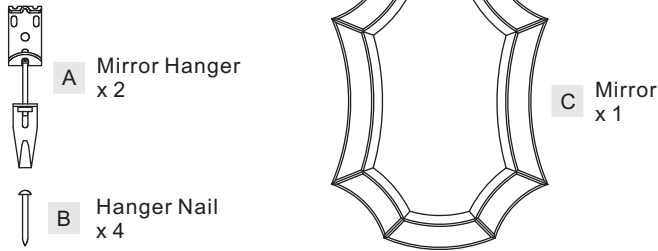

**NOTE:** There are two options (Templates or Measurement) for identifying correct locations for Nails.

#### Option A - Identify Nail Points for mounting the Mirror Hangers By Using Template

The template included with package is provided to assist you in placing the mirror in the location you desire. The template is a full size drawing of your mirror and includes hanger mounting locations that your mirror maybe hung.

Place the template on the wall in the location you have selected for your mirror. Once you have the template in the location you desire and making sure it is level you may tape or pin the template to the wall. Now you may mark the holes for the mounting hardware as indicated on your template. You may mark the mounting hardware location by either using a pin and pushing it through the template leaving a small hole on the wall. Or you may use a pencil and place a mark on the wall through a small hole you cut into the template at the correct mounting location.

Remove the template from the wall and install the Mirror Hangers as described in Step 1.

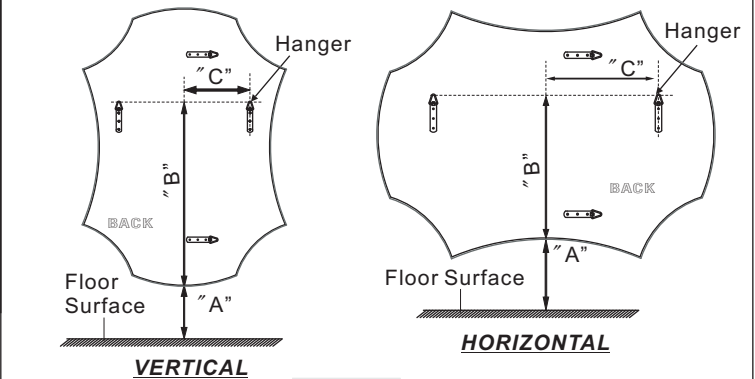
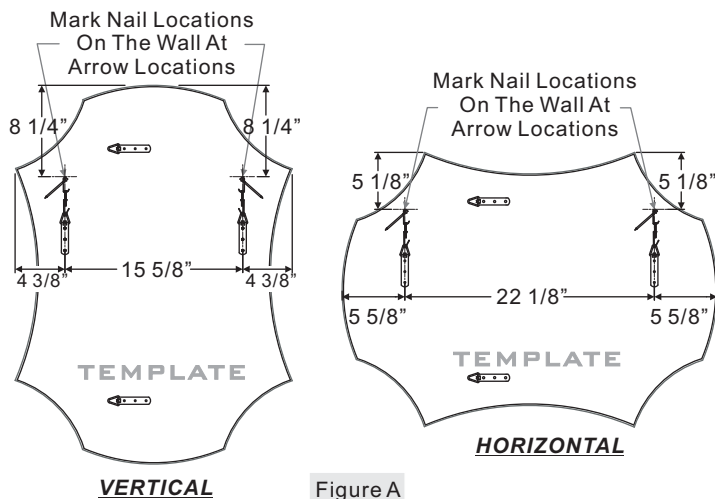

Figure B1

#### Option B - Identify the Points for mounting the Mirror Hangers By Using Measurement

- Determine where the mirror will be placed on the wall and hold the mirror on the wall in the position you wish. Mark the wall at the bottom center of the mirror with a pencil lightly. This will be Measurement A, the distance from the floor to the bottom of the mirror.
- Place the mirror on a flat surface again and measure from the bottom of the mirror to the hangers that will be used to hang the mirror, this is measurement B.
- Add measurement A from step A above and measurement B together and mark this spot on the wall where the mirror will be hung. Measurement B is straight up from Measurement A you marked on the wall in step A above.
- Measure the distance between the centerline of each hanger and then divide this measurement by 2, this is Measurement C. In order to locate the exact hanger location on the wall, from Measurement B go to the right the distance of Measurement C and mark the wall. Do this going to the left of Measurement B as well and mark the wall. These two marks are the center of the hangers, Measurement C. The two marks you just made on the wall are the same distance apart as the two hangers.
- (Refer Figure B2) To determine where the Mirror Hangers (A) will be fastened to the wall, measure up from Measurement C 3". Do this in two locations as illustrated and mark the wall.
- Refer to Step 1 to install Mirror Hangers on the wall.

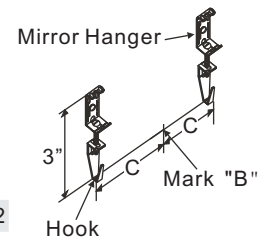

Figure B2

#### STEP 1 - Installing the 2 Mirror Hangers

- Using the Nails (B) provided with the Mirror Hangers (A) attach the 2 Mirror Hangers (A) to the wall at the position just marked by Option A or Option B. **Please note the Mirror Hangers are adjustable allowing for easy leveling of the mirror as needed.**
- Once you have both Mirror Hangers (A) securely nailed in place,

Thank you for purchasing a Quoizel product.  
Need assistance with parts or assembly? Call Quoizel customer service at 1-800-645-3184  
or visit us on-line at [www.quoise.com](http://www.quoise.com)

**(Step 1 Continued)**

adjust as the length of the Mirror Hangers (A) so that each Mirror Hanger (A) is the same length.

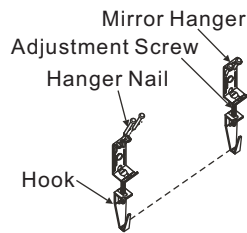
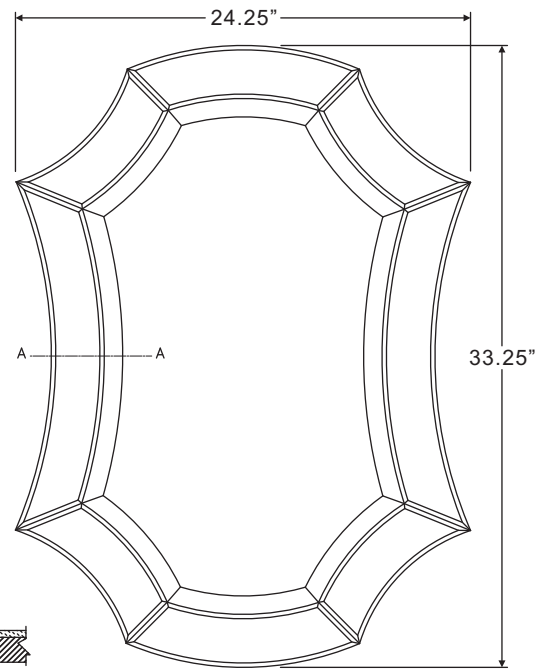
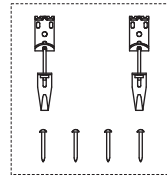

Figure 1

QR2800



**STEP 2 – Hanging the Mirror**

- A. With the help of another person place the mirror onto the mirror hanger hooks. Making sure each hook is securely hooked into the hangers before letting go of the mirror.
- B. If needed you May remove the mirror and adjust the mirror hanger hooks to level the mirror and replace the mirror.

Clean glass with household glass cleaner. Retain this sheet for future reference.

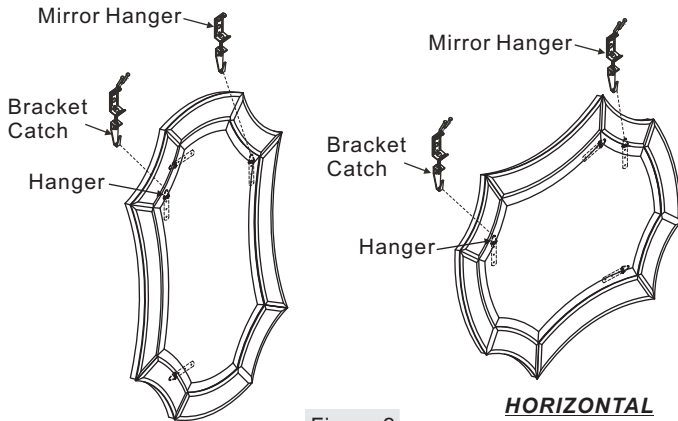

Figure 2

**VERTICAL**

**HORIZONTAL**

NOTE: ALL DIMENSIONS ARE ROUNDED UP TO THE NEAREST 1/4"

NO.	PART NUMBER	REPLACEMENT PART DESCRIPTION	QTY.
1			

Thank you for purchasing a Quoizel product.  
 Need assistance with parts or assembly? Call Quoizel customer service at 1-800-645-3184  
 or visit us on-line at [www.quoizel.com](http://www.quoizel.com)