

Type _____

-09 -74

P2733

Finish

Catalog No.	Finish		Lamping	Dimensions (Inches)			
	Brushed Nickel	Venetian Bronze		A	B	C	D
P2733	-09	-74	1 (m) 100w	5-1/2	10-1/8	7-1/8	4

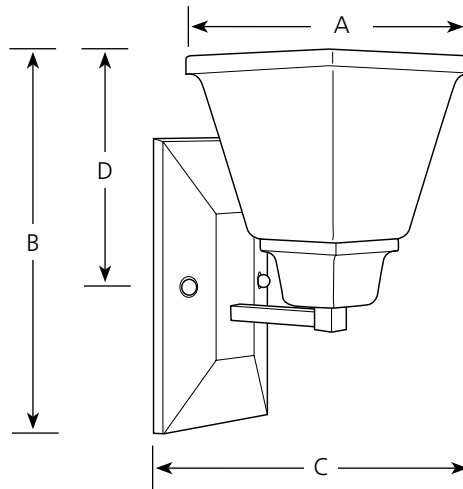

Specifications:

General

- Square etched glass shade: 5-1/2" dia. x 5" ht., 1-5/8" center hole
- Plated Brushed Nickel (-09) or painted Venetian Bronze (-74) finish
- Can be mounted in "up" or "down" position
- Steel construction
- Companion foyer, chandelier, pendant, close to ceiling, and bath and vanity units

Mounting

- Wall mounted
- Unit covers a standard 4" recessed octagonal outlet box
- Canopy is 4-1/4" W x 8" T x 1" deep
- Mounting strap for outlet box included

Electrical

- Medium based ceramic socket
- Pre-wired

Labeling

- UL-CUL listed