



Compact Fluorescent
Trim

6" Pro-Optic™ Baffle
2 Horizontal Quad Tube Lamps
Non-IC

Recessed

Type _____
-28 -31
P8031

Catalog No.	Finish		Dimensions (Inches)		
	White	Black	A	B	C
P8031	-28	-31	7	5-3/4	4-3/4

Maximum Ceiling Thickness = 1-1/4"

Ceiling Opening = 6-1/4"
(See guide for Retrofit)

P163H, P168H, P16H

HOUSING COMPATIBILITY GUIDE

ORDERING GUIDELINES	6 INCH OPENING RANGE	
	MIN	MAX
REQUIRES SD HOUSING OPTION	5-15/16	6-1/8
ALL STANDARD HOUSINGS	6-1/8	6-1/2
ONLY P8030 SERIES TRIMS AVAILABLE: 'WF' OPTION	6-1/2	6-7/8

Dimensions shown are for the diameter of the frame flange at it's narrowest point

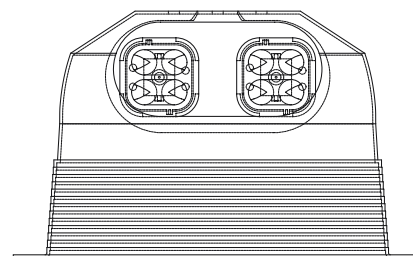
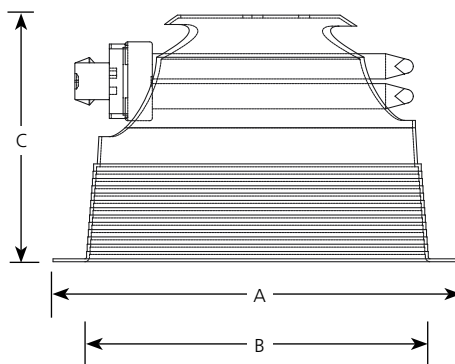
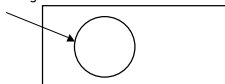

Lamp Wattage

Housings

New Construction	Retrofit	IC	Non-IC
P63-EB	P163H-EB	N/A	2-13w Quad tube
P68-EB	P168H-EB	N/A	2-18w Quad tube
P66-EB	P166H-EB	N/A	2-26w Quad tube
P66-DM	P166H-DM	N/A	2-26w Quad tube

Specifications:

Flange

- White painted metal flange

Reflector

- All aluminum construction
- One piece construction with integral flange
- Alzak anodized upper conoid reflector provides superior efficiency
- Painted lower baffle provides excellent glare control
- No light leaks around trim flange
- Socket box mounts to reflector for optimum performance and consistent lamp position

- Reflector retention accomplished by 3 spring clips located in aperture of housing
- Spun aluminum multigroove step baffle
- Single reflector accommodates both standard and internal emergency housings

Labeling

- cCSAus listed for damp location
- Non-IC rated

Progress Lighting
701 Millennium Blvd.
Greenville, South Carolina
29607

www.progresslighting.com

Rev. 8/10



Compact
Fluorescent Trim

6" Pro-Optic FireBox® Baffle
2 Horizontal Lamps
Non-IC

Recessed

Type _____
-28FB -31FB
P8031

Catalog No.	Finish		Dimensions (Inches)		
	White	Black	A	B	C
P8031	-28FB	-31FB	7-3/4	6-3/8	5-1/4

Maximum Ceiling Thickness: 1-1/8"

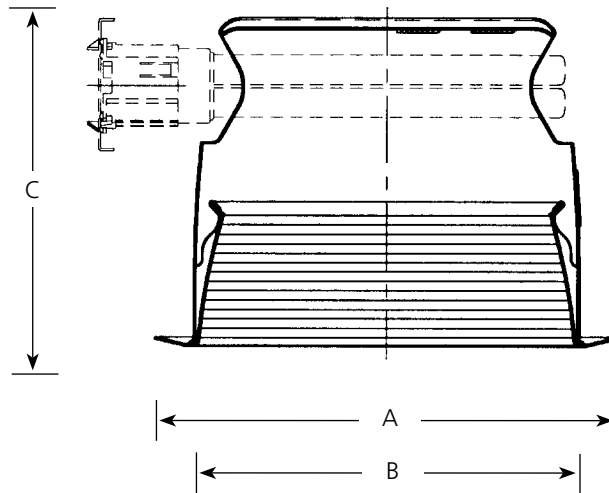

Lamp Wattage

Housing	IC	Non-IC
P63-EBFB	N/A	2 13w Quad 4 Pin
P68-EBFB	N/A	2 18w Quad 4 Pin
P66-EBFB	N/A	2 26w Quad 4 Pin

Specifications:

Flange

- White painted metal flange

Trim

- All aluminum construction
- One piece construction with integral flange
- No light leaks around trim flange
- Socket box mounts to reflector for optimum performance and consistent lamp position
- Reflector retention accomplished by 3 spring clips located in aperture of housing
- Spun aluminum multigroove step baffle
- White (-28) or Black (-31) painted

Labeling

- UL-CUL listed for damp locations
- Non-IC rated

Progress Lighting
701 Millennium Blvd.
Greenville, South Carolina
29607

www.progresslighting.com
Patent# 6,254,257



P66-EBFB

P66-EBFB WITH P8031-28FB

Report No. 98178

No. Lamps: 2 Type Lamp: 26W CF QUAD-GE Total Lumens: 3400

Fixture Efficiency: 35.8%

S/MH Ratio: 0.9 (0°) 1.1 (90°)

Single Fixture Data

Ceiling Ht.(Ft.)	10% Values		Zero Degrees	50% Values	
	Beam Angle - 92°			Beam Angle - 53°	
	Ft.-C	Beam Dia.		Ft.-C	Beam Dia.
8	2.5	11	25.2	12.6	5
10	1.4	16	13.6	6.8	7
12	0.8	20	8.5	4.2	9
14	0.6	24	5.8	2.9	11
16	0.4	28	4.2	2.1	13

Ft.-C (Footcandles) are initial and measured 2'-6" from floor

Quick Calculator Charts

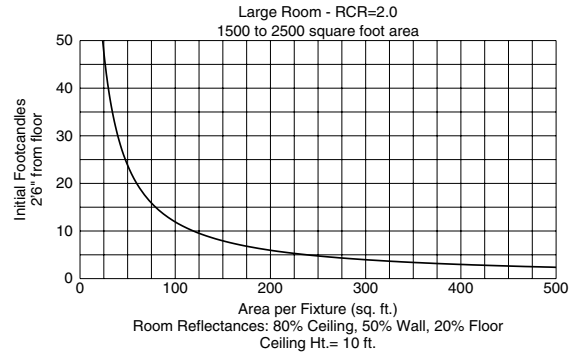
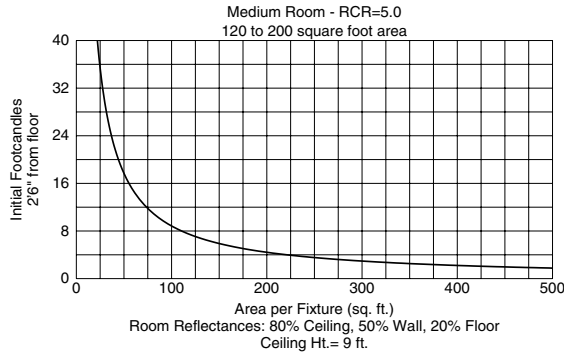

DISTRIBUTION CURVE

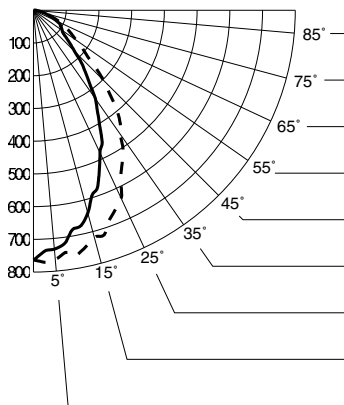

INTENSITY DATA

DEGREES	CANDELA	
	AT 0°	AT 90°
90	0	0
85	11	13
80	23	26
75	37	41
70	58	63
65	79	92
60	95	125
55	107	160
50	132	211
45	178	302
40	247	395
35	330	462
30	404	542
25	481	634
20	574	680
15	641	719
10	681	760
5	733	765
0	763	763

ZONAL CAVITY COEFFICIENTS OF UTILIZATION

RC	Effective Floor Cavity Reflectance 0.20																							
	80				70				50				30				10				0			
	RW	70	50	30	10	70	50	30	10	50	30	10	50	30	10	50	30	10	50	30	10	0		
0	43	43	43	43	42	42	42	42	40	40	40	38	38	38	37	37	37	36	36	36	36			
1	40	38	37	36	39	38	37	36	36	35	34	35	34	33	34	33	32	32	32	32	32			
2	37	35	33	31	36	34	32	31	33	31	30	32	30	29	31	29	29	28	28	28	28			
3	34	31	29	27	33	31	28	27	30	28	26	29	27	26	28	26	25	25	25	25	25			
4	32	28	26	24	31	28	25	23	27	25	23	26	24	23	25	24	23	22	22	22	22			
5	30	26	23	21	29	25	23	21	25	22	21	24	22	21	23	22	20	20	20	20	20			
6	28	24	21	19	27	23	21	19	23	20	19	22	20	19	22	20	18	18	18	18	18			
7	26	22	19	17	25	21	19	17	21	19	17	21	18	17	20	18	17	16	16	16	16			
8	24	20	17	16	24	20	17	16	19	17	15	19	17	15	19	17	15	15	15	15	15			
9	23	19	16	14	22	18	16	14	18	16	14	18	16	14	17	15	14	14	14	14	14			
10	22	17	15	13	21	17	15	13	17	15	13	17	15	13	16	14	13	12	12	12	12			



P68-EBFB

P68-EBFB WITH P8031-28FB

Report No. 98214

No. Lamps: 2 Type Lamp: 18W CF QUAD-GE Total Lumens: 2500

Fixture Efficiency: 38.7%

S/MH Ratio: 1.0 (0°) 1.0 (90°)

Single Fixture Data

Ceiling Ht.(Ft.)	10% Values		Zero Degrees	50% Values	
	Beam Angle - 90°			Beam Angle - 53°	
	Ft.-C	Beam Dia.		Ft.-C	Beam Dia.
8	2.1	11	21.1	10.5	5
10	1.1	15	11.3	5.7	7
12	0.7	19	7.1	3.5	9
14	0.5	23	4.8	2.4	11
16	0.3	27	3.5	1.7	13

Ft.-C (Footcandles) are initial and measured 2'-6" from floor

Quick Calculator Charts

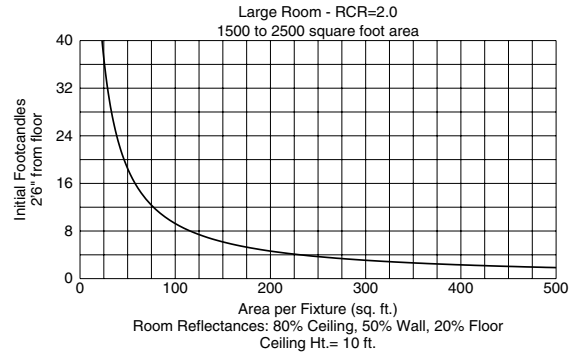
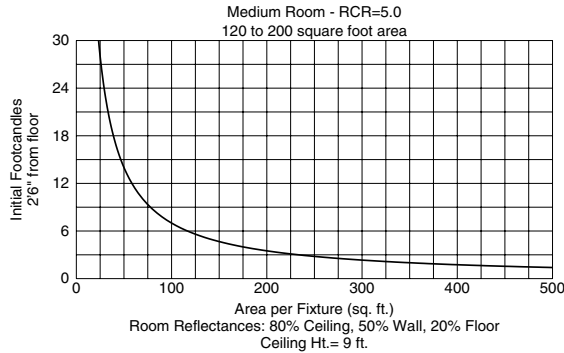

DISTRIBUTION CURVE

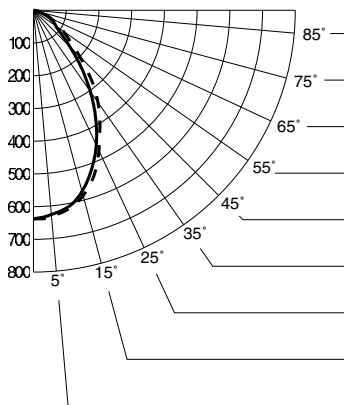

INTENSITY DATA

DEGREES	CANDELA	
	AT 0°	AT 90°
90	0	0
85	3	6
80	11	15
75	21	25
70	33	39
65	51	59
60	71	83
55	83	111
50	108	144
45	158	200
40	226	273
35	303	343
30	380	406
25	454	473
20	518	539
15	573	586
10	610	617
5	627	632
0	637	637

ZONAL CAVITY COEFFICIENTS OF UTILIZATION

RC	Effective Floor Cavity Reflectance 0.20																							
	80				70				50				30				10				0			
	RW	70	50	30	10	70	50	30	10	50	30	10	50	30	10	50	30	10	50	30	10	0		
0	46	46	46	46	45	45	45	45	43	43	43	41	41	41	40	40	40	39	39	39	39			
1	43	42	40	39	42	41	40	39	39	38	37	38	37	36	36	36	35	34	34	34	34			
2	40	37	35	34	39	37	35	33	35	34	32	34	33	32	33	32	31	30	30	30	30			
3	37	34	31	29	36	33	31	29	32	30	28	31	29	28	30	29	28	27	27	27	27			
4	35	31	28	26	34	30	28	26	29	27	25	29	27	25	28	26	25	24	24	24	24			
5	32	28	25	23	32	28	25	23	27	25	23	26	24	22	26	24	22	21	21	21	21			
6	30	26	23	21	30	25	23	21	25	22	20	24	22	20	24	22	20	19	19	19	19			
7	28	24	21	19	28	23	21	19	23	20	19	22	20	19	22	20	18	18	18	18	18			
8	27	22	19	17	26	22	19	17	21	19	17	21	19	17	20	18	17	16	16	16	16			
9	25	20	18	16	25	20	18	16	20	17	16	19	17	16	19	17	16	15	15	15	15			
10	24	19	16	15	23	19	16	15	19	16	15	18	16	14	18	16	14	14	14	14	14			



P66-EBFB

P66-EBFB WITH P8031-31FB

Report No. 98179

No. Lamps: 2 Type Lamp: 26W CF QUAD-GE Total Lumens: 3400

Fixture Efficiency: 25.2%

S/MH Ratio: 0.9 (0°) 1.0 (90°)

Single Fixture Data

Ceiling Ht.(Ft.)	10% Values		Zero Degrees	50% Values	
	Beam Angle - 87°			Beam Angle - 51°	
	Ft.-C	Beam Dia.		Ft.-C	Beam Dia.
8	2.2	10	21.7	10.8	5
10	1.2	14	11.6	5.8	7
12	0.7	18	7.3	3.6	9
14	0.5	22	5.0	2.5	11
16	0.4	26	3.6	1.8	13

Ft.-C (Footcandles) are initial and measured 2'-6" from floor

Quick Calculator Charts

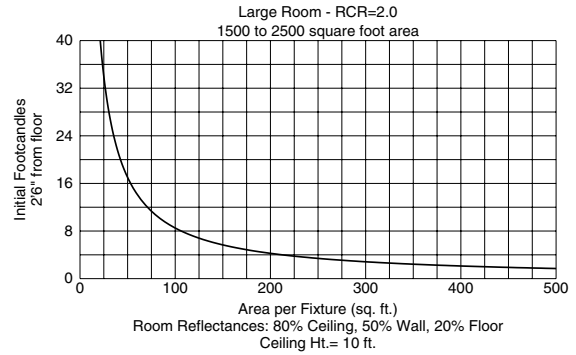
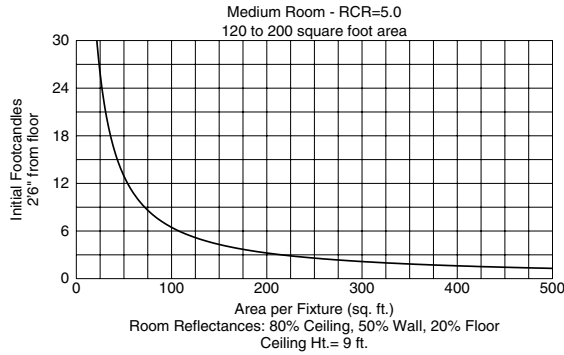

DISTRIBUTION CURVE

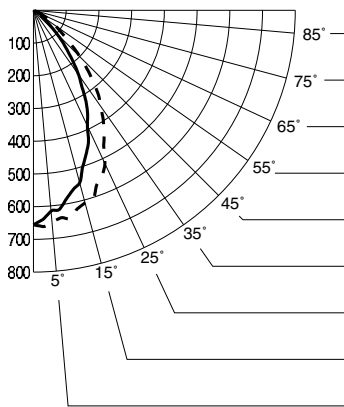

INTENSITY DATA

DEGREES	CANDELA	
	AT 0°	AT 90°
90	0	0
85	0	0
80	1	1
75	1	1
70	2	6
65	14	24
60	27	49
55	34	80
50	55	125
45	100	203
40	163	284
35	241	356
30	321	432
25	390	517
20	469	566
15	546	609
10	584	646
5	616	649
0	655	655

ZONAL CAVITY COEFFICIENTS OF UTILIZATION

RC	Effective Floor Cavity Reflectance 0.20																				
	80				70				50				30				10				0
	RW	70	50	30	10	70	50	30	10	50	30	10	50	30	10	50	30	10	50	30	10
0	30	30	30	30	29	29	29	29	28	28	28	27	27	27	26	26	26	25	25	25	25
1	28	27	27	26	28	27	26	26	26	25	25	25	25	24	24	24	23	23	23	23	23
2	27	25	24	23	26	25	24	23	24	23	22	23	22	22	22	22	21	21	21	21	21
3	25	23	22	20	24	23	21	20	22	21	20	21	20	20	21	20	19	19	19	19	19
4	23	21	20	18	23	21	19	18	20	19	18	20	19	18	19	18	18	17	17	17	17
5	22	19	18	17	21	19	18	16	19	17	16	18	17	16	18	17	16	16	16	16	16
6	21	18	16	15	20	18	16	15	17	16	15	17	16	15	17	16	15	15	15	15	15
7	19	17	15	14	19	16	15	14	16	15	14	16	14	13	16	14	13	13	13	13	13
8	18	15	14	13	18	15	14	13	15	14	12	15	13	12	15	13	12	12	12	12	12
9	17	14	13	12	17	14	13	12	14	13	12	14	12	11	14	12	11	11	11	11	11
10	16	14	12	11	16	13	12	11	13	12	11	13	12	11	13	12	11	11	11	11	11



P68-EBFB

P68-EBFB WITH P8031-31FB

Report No. 98215

No. Lamps: 2 Type Lamp: 18W CF QUAD-GE Total Lumens: 2500

Fixture Efficiency: 27.7%

S/MH Ratio: 1.0 (0°) 1.1 (90°)

Single Fixture Data

Ceiling Ht.(Ft.)	10% Values		Zero Degrees	50% Values	
	Beam Angle - 89°			Beam Angle - 54°	
	Ft.-C	Beam Dia.		Ft.-C	Beam Dia.
8	1.8	11	18.1	9.0	6
10	1.0	15	9.7	4.9	8
12	0.6	19	6.1	3.0	10
14	0.4	23	4.1	2.1	12
16	0.3	27	3.0	1.5	14

Ft.-C (Footcandles) are initial and measured 2'-6" from floor

Quick Calculator Charts

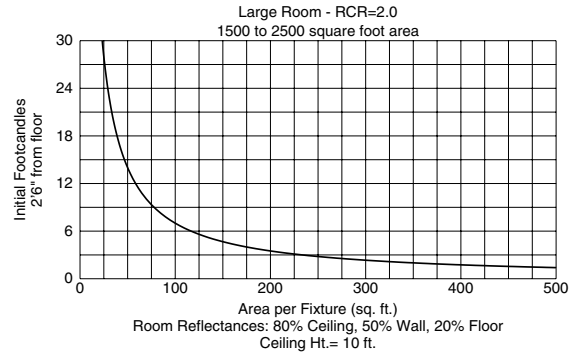
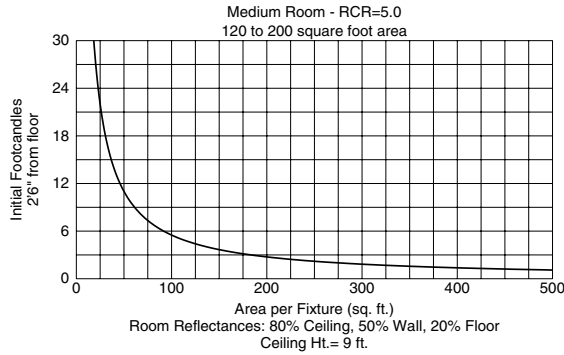

DISTRIBUTION CURVE

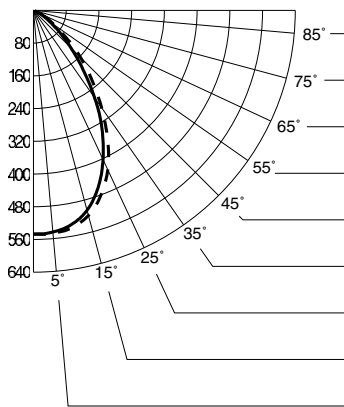

INTENSITY DATA

DEGREES	CANDELA	
	AT 0°	AT 90°
90	0	0
85	0	0
80	0	1
75	1	1
70	4	3
65	18	17
60	33	37
55	50	63
50	84	106
45	130	163
40	189	223
35	261	290
30	335	362
25	402	430
20	462	481
15	506	519
10	532	540
5	544	547
0	547	547

ZONAL CAVITY COEFFICIENTS OF UTILIZATION

RC	Effective Floor Cavity Reflectance 0.20																							
	80				70				50				30				10				0			
	RW	70	50	30	10	70	50	30	10	50	30	10	50	30	10	50	30	10	50	30	10	0		
0	33	33	33	33	32	32	32	32	31	31	31	29	29	29	28	28	28	28	28	28	28	28		
1	31	30	30	29	30	30	29	28	29	28	27	28	27	27	27	26	26	26	25	25	25	25		
2	29	28	26	25	29	27	26	25	26	25	25	26	25	24	25	24	24	23	23	23	23	23		
3	28	25	24	23	27	25	24	22	24	23	22	24	23	22	23	22	21	21	21	21	21	21		
4	26	23	22	20	25	23	21	20	22	21	20	22	21	20	21	20	19	19	19	19	19	19		
5	24	22	20	18	24	21	20	18	21	19	18	20	19	18	20	19	18	17	17	17	17	17		
6	23	20	18	17	22	20	18	17	19	18	17	19	17	16	18	17	16	16	16	16	16	16		
7	21	19	17	15	21	18	17	15	18	16	15	18	16	15	17	16	15	15	15	15	15	15		
8	20	17	15	14	20	17	15	14	17	15	14	16	15	14	16	15	14	14	14	14	14	14		
9	19	16	14	13	19	16	14	13	16	14	13	15	14	13	15	14	13	13	13	13	13	13		
10	18	15	13	12	18	15	13	12	15	13	12	14	13	12	14	13	12	12	12	12	12	12		