

**OL-27**

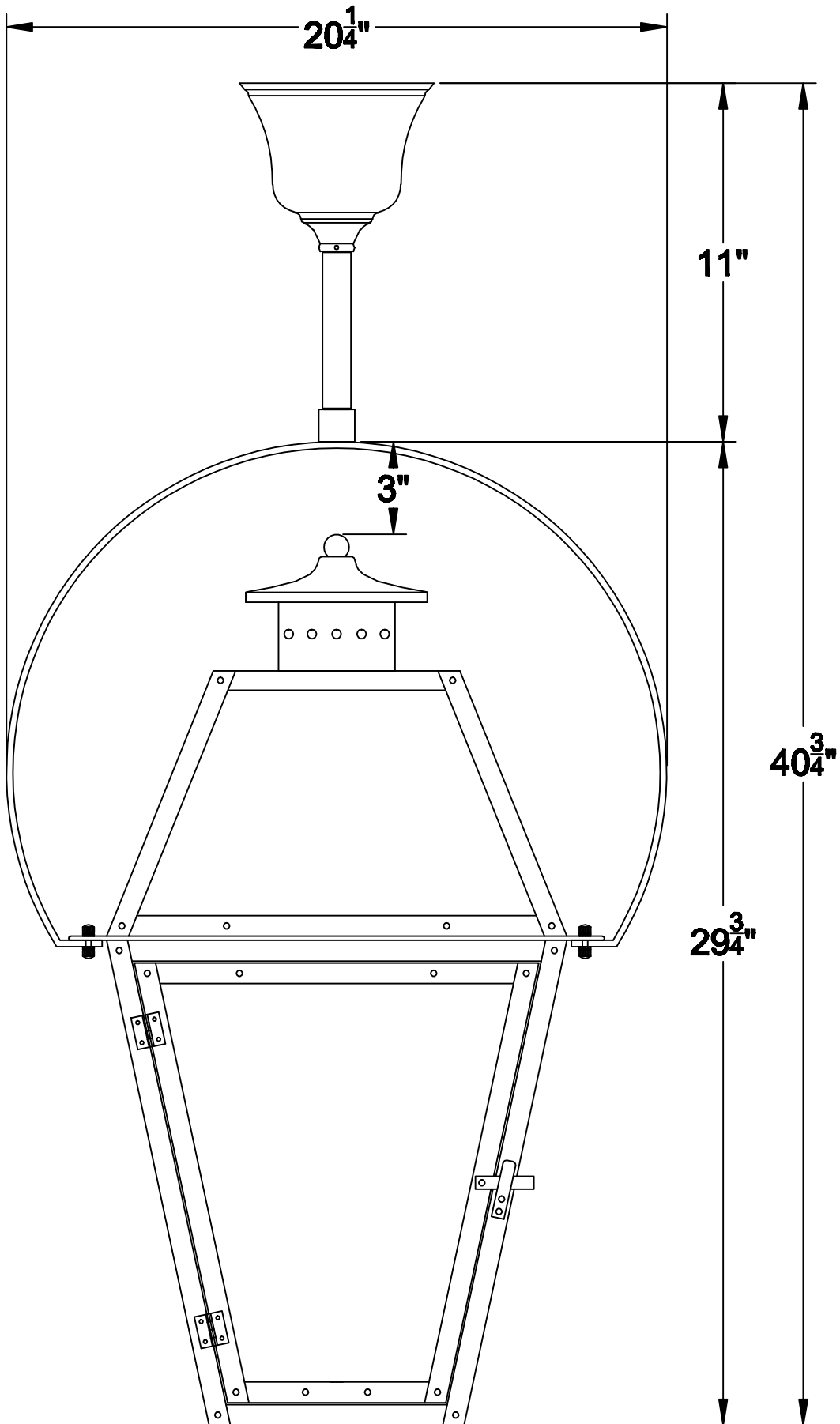

**HY-3**