

Installation Support • Soporte de instalación • Support d'installation

Personal Assistance, Product Specs, & "How-to" Questions:

Asistencia personal, especificaciones del producto y preguntas sobre "cómo hacerlo":

Aide personnelle, spécifications du produit et questions « pratique-pratiques » :

1-800-PFAUCET (732-8238)

pfisterfaucets.com/support

Installation Videos Available
Videos de instalación a disposición
Vidéos d'installation disponibles



pfisterfaucets.com/videos

▲ WARNING / ADVERTENCIA / AVERTISSEMENT

To reduce the risk of injury or property damage, read all instructions before installing product. Wear safety goggles. Product must be installed in accordance with all state & local plumbing & building codes. Call a professional if you are uncertain about installing this product.

Para disminuir el riesgo de lesiones o daños a la propiedad, lea todas las instrucciones antes de instalar el producto. Utilice gafas de seguridad. El producto deberá instalarse de acuerdo con la normativa de plomería y construcción estatal y local. Llame a un profesional si no está seguro sobre cómo instalar este producto.

Pour réduire le risque de blessures ou de dommages, lisez toutes les instructions avant d'installer l'appareil. Porter des lunettes de sécurité. Il faut installer l'appareil en respectant tous les codes de construction et de plomberie locaux et d'État. Appelez un professionnel si vous n'êtes pas certain de la façon d'installer cet appareil.

Required Tools

Herramientas necesarias
Outils nécessaires



Adjustable Wrench
Llave ajustable
Clé réglable



Safety Goggles
Anteojos de seguridad
Lunettes de sûreté

Additional Helpful Tools

Otras herramientas útiles
Outils supplémentaires utiles



Flashlight
Linterna
Lampe De Poche



Cloth
Paño de limpieza
Chiffon

Parts in the Box • Piezas en la caja • Pièces dans la boîte

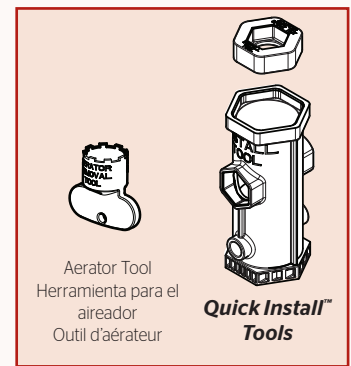
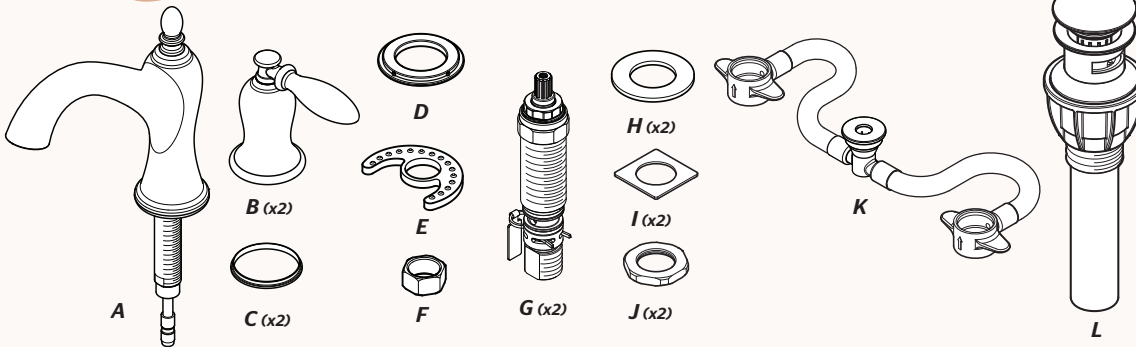

Aerator Tool
Herramienta para el aireador
Outil d'aérateur

**Quick Install™
Tools**

1 Turn Off Water Supply • Cierre el suministro de agua • Couper l'alimentation en eau



Locate water supply inlets and shut off the water supply valves. These are usually found under the sink or near the water meter. If you are replacing an existing faucet, remove the old faucet from the sink and clean the sink surface thoroughly.

Ubique las entradas del suministro de agua y cierre las válvulas de suministro de agua. Generalmente se encuentran debajo del fregadero o cerca del medidor de agua. Si se trata de un reemplazo de grifo, quite el grifo viejo y limpie completamente la superficie del fregadero.

Repérer les arrivées d'eau et fermer leurs robinets. Ces robinets se trouvent généralement sous le lavabo ou à côté du compteur d'eau. En cas de remplacement d'un robinet existant, le déposer du lavabo et nettoyer soigneusement la surface de ce dernier.

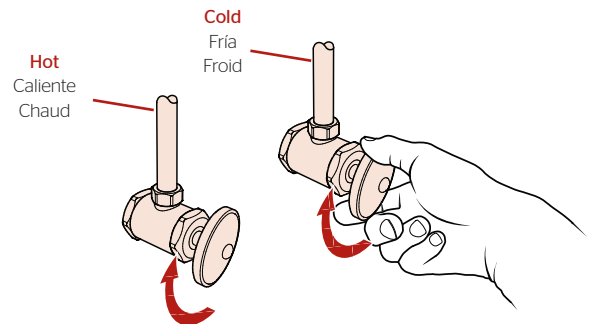

2 Prepare & Install Valve Bodies

Prepare e instale los cuerpos de la válvula

Préparez et installez les vannes

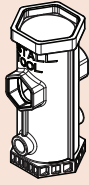

Quick Install™ Tool



Adjustable Wrench
Llave ajustable
Clé réglable



G (x2)



H (x2)



I (x2)



J (x2)

2A

Disassemble Valves

Desensamble las válvulas

Démontez les valves

x2

Hot & Cold
Caliente y fría
Chaud et froid

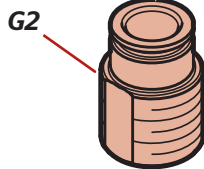
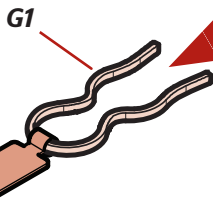
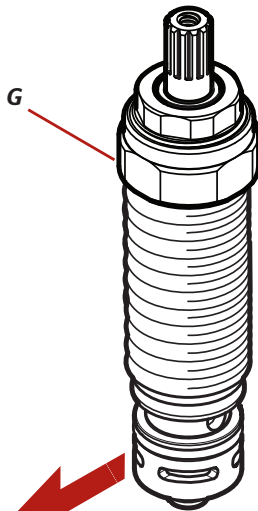

2B

Temporarily place handles onto stems to align the levers. **DO NOT** use handles to tighten valve.

Coloque temporalmente las manijas en los vástagos para alinear las palancas. **NO** utilice las manijas para apretar la válvula.

Placer temporairement les poignées sur les tiges pour aligner les leviers. **NE PAS** utiliser les poignées pour serrer la valve.

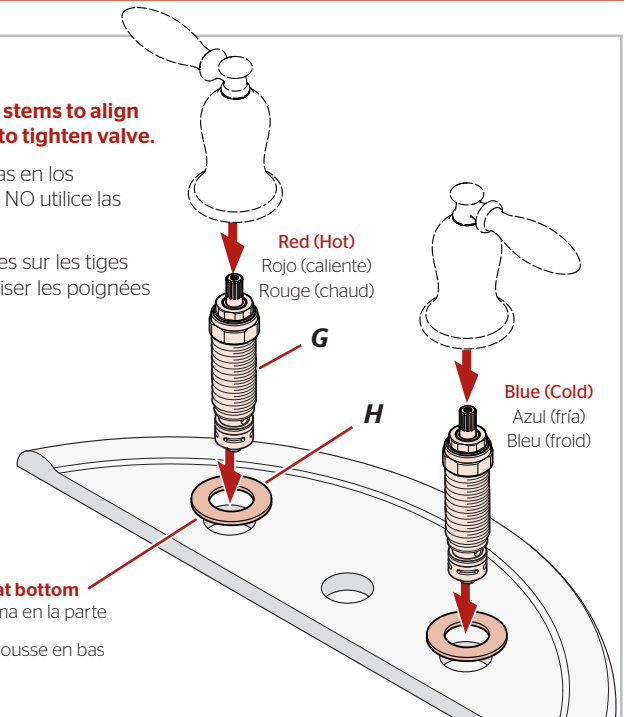

Foam gasket at bottom
Junta de espuma en la parte inferior
Garniture de mousse en bas

2C

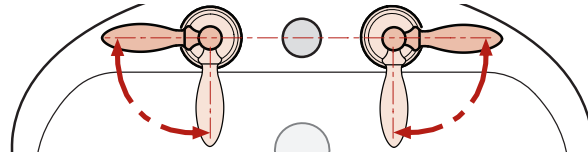

Before final tightening, be sure that both handles rotate correctly. As shown.

Antes del apriete final, asegúrese de que ambas manijas giren correctamente. Tal como se muestra.

Avant le serrage final, soyez sûr que les deux poignées basculent correctement. Comme démontré.

2D

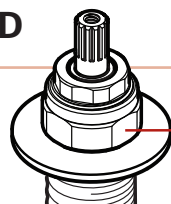

Flats
Planos
Appartements

Hold flats in position with a wrench while tightening nut (J) with the Quick Install™ Tool.

Sujete los lados en posición con una llave mientras aprieta la tuerca (J) con la Quick Install™ herramienta.

Tenez les côtés en position avec une clé tout en serrant l'écrou (J) la Quick Install™ outil.

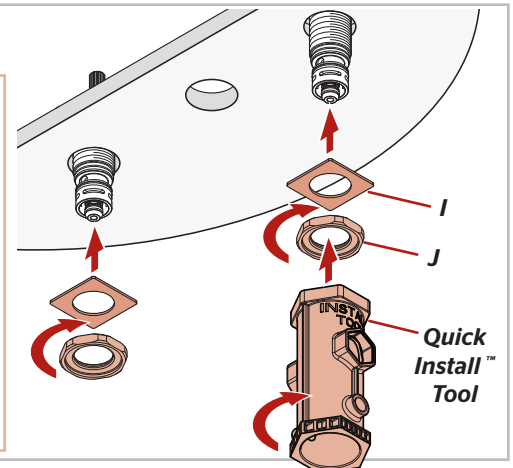

Quick Install™ Tool



Save for step 5.

Guarde para el paso 5.

Mettez de l'étape 5.

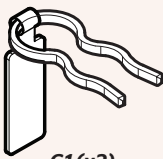

G1 (x2)



G2 (x2)

3

Install Handles & Spout

Instale las manijas y el surtidor

Installez les poignées et le bec

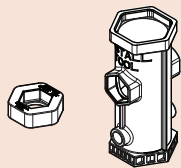

Quick Install™
Tools

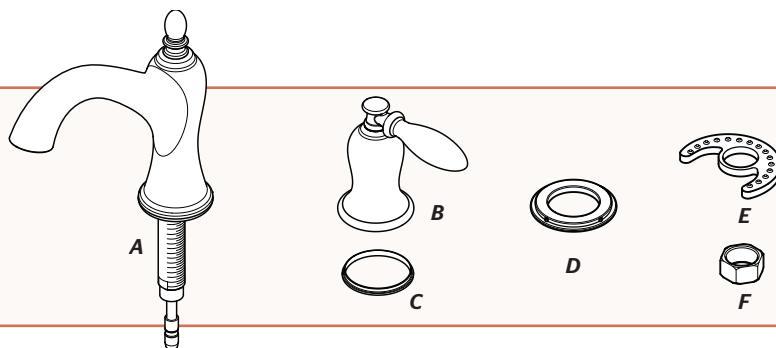

3A

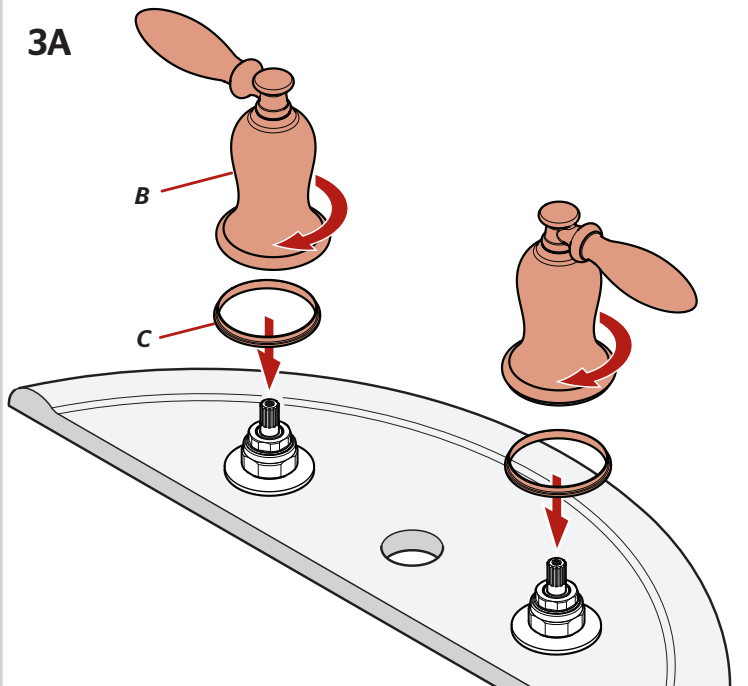

3B

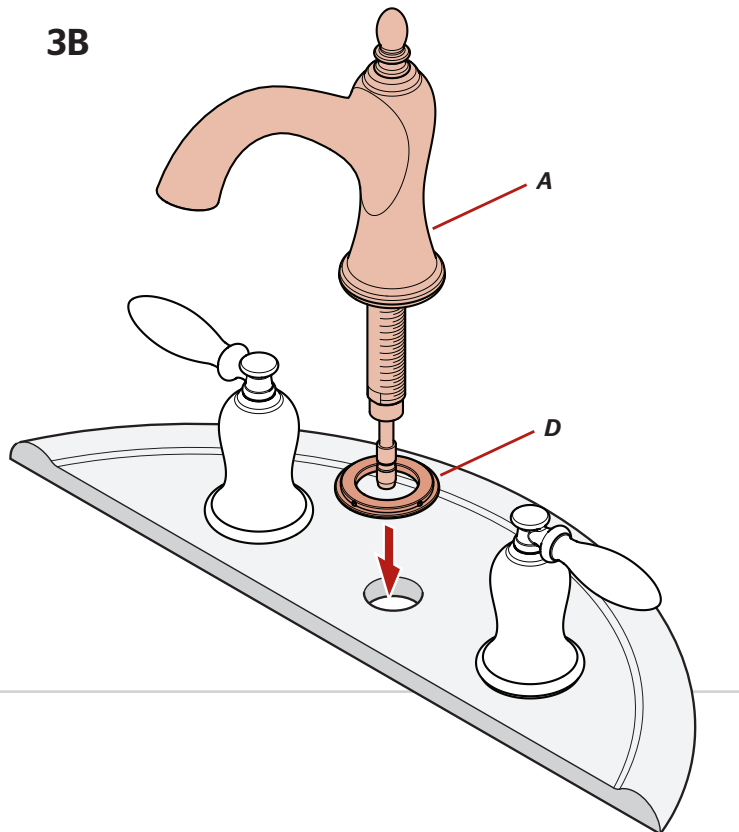

3C

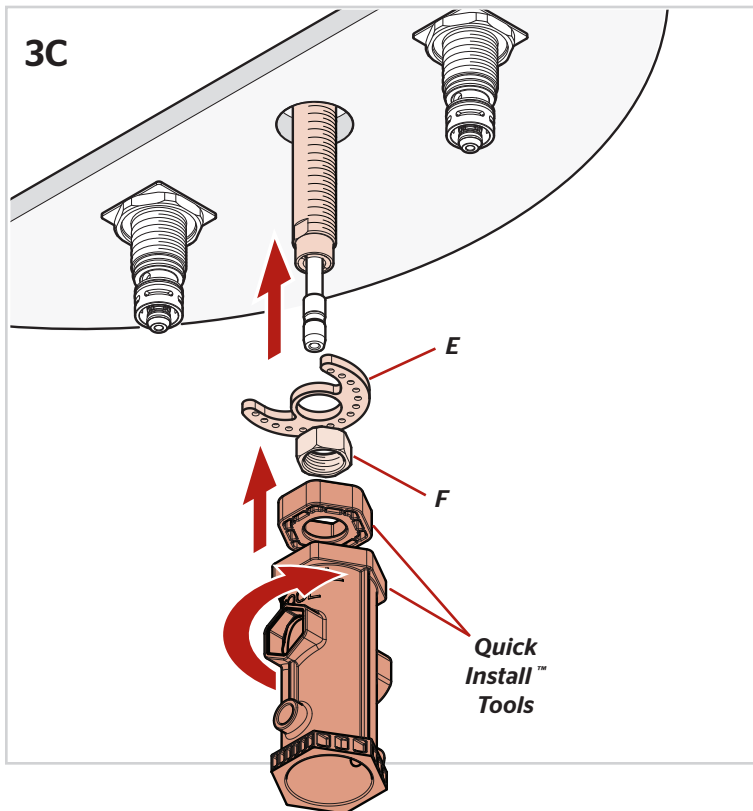

Make sure that the bumps on the metal washer (E) are facing up. Be sure the spout body (A) is centered & facing forward.

IMPORTANT: DO NOT OVERTIGHTEN.

Cerciórese que las protuberancias de la arandela metálica (E) estén orientadas hacia arriba. Cerciórese que la estructura del surtidor (A) esté centrada y orientada hacia adelante. **IMPORTANT: NO APRIETE EXCESIVAMENTE.**

Vérifiez que les bosses sur la rondelle de métal (E) sont tournées vers le haut. Assurez-vous que le bec (A) est centré et tourné vers le haut. **IMPORTANT: NE PAS TROP SERRER.**

4 Install Hose

Instale la manguera

Posez le tuyau

No Tools Required for This Step
No se necesitan herramientas para este paso
Aucun outil n'est nécessaire pour cette étape

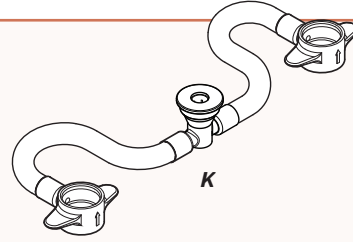

Remove protective cap

Retire la cubierta protectora.

Enlevez le capuchon protecteur.

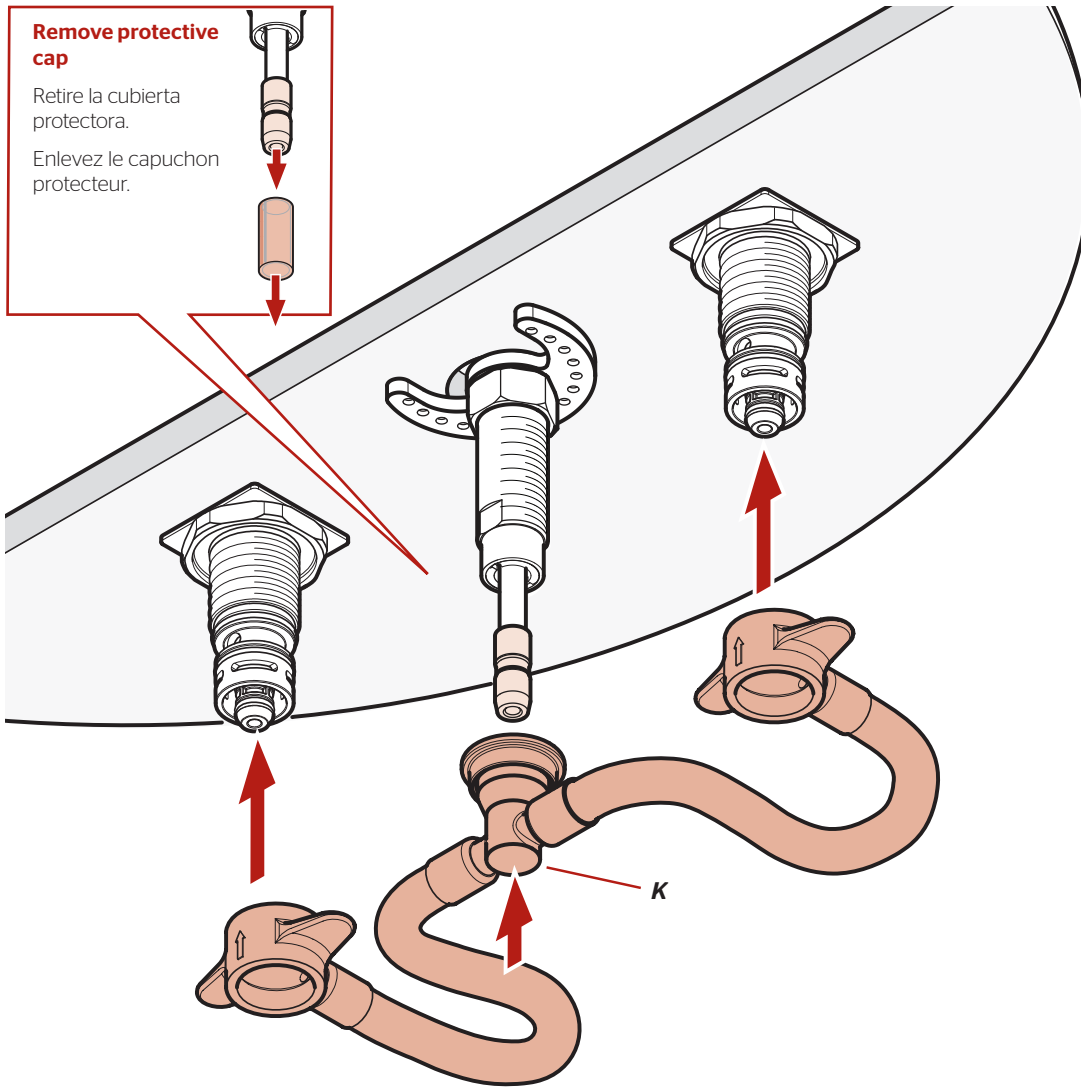
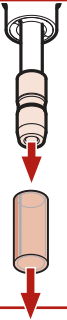

IMPORTANT: DO NOT damage O-Rings.

IMPORTANTE: NO dañe las juntas tóricas.

IMPORTANT: NE PAS endommager les joints toriques.

x2

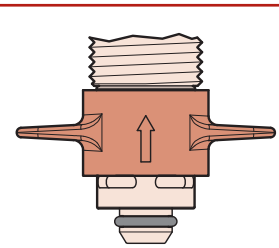
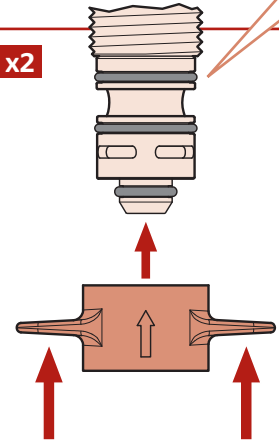

Check to see if the connection is secure by pulling down the center connector avoiding the green cap. If it does not pull off the receiving tube, connection is secure.

Compruebe para ver si la conexión es segura tirando abajo del conector de centro que evita el casquillo verde. Si no arranca el tubo de recepción, la conexión es segura.

rifiez pour voir si le raccordement est bloqué par la traction en bas du connecteur central évitant le chapeau vert. S'il ne retire pas le tube de réception, le raccordement est bloqué

Center Connector
Centre el conector
Raccord centre

Green Cap
Casquillo verde
Chapeau vert

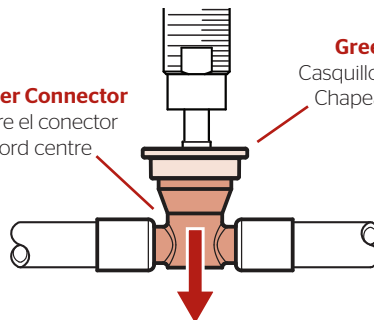

5

Connect Water Supply Lines

Conecte las tuberías de suministro de agua

Raccorder les conduites d'alimentation en eau

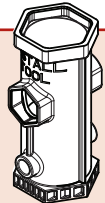

Quick Install™ Tool

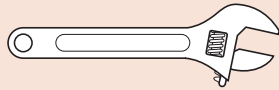

Adjustable Wrench
Llave ajustable
Clé réglable



G1 (x2)



G2 (x2)

From Step 2.

Desde el paso 2.

De l'étape 2.



Water Supply Lines not included. Please consult manufacturer and/or its instructions for the correct method of installation of supply lines & fittings.

IMPORTANT: Incorrect application of supply lines and fittings may result in the failure or leak of the supply lines and fitting.

Las tuberías de suministro de agua no están incluidas. Consulte por favor el fabricante y/o sus instrucciones para el método correcto de instalación de líneas de suministro y de guarniciones.

IMPORTANT: El uso incorrecto de líneas de suministro y de guarniciones puede dar lugar a la falta o al escape de las líneas de suministro y de la guarnición.

Les tuyaux d'arrivée d'eau ne sont pas fournis. Veuillez consulter le fabricant et/ou ses instructions pour la méthode correcte d'installation des canalisations et des garnitures d'alimentation.

IMPORTANT: L'application incorrecte des canalisations et des garnitures d'alimentation peut avoir comme conséquence l'échec ou la fuite des canalisations et de l'ajustage de précision d'alimentation.

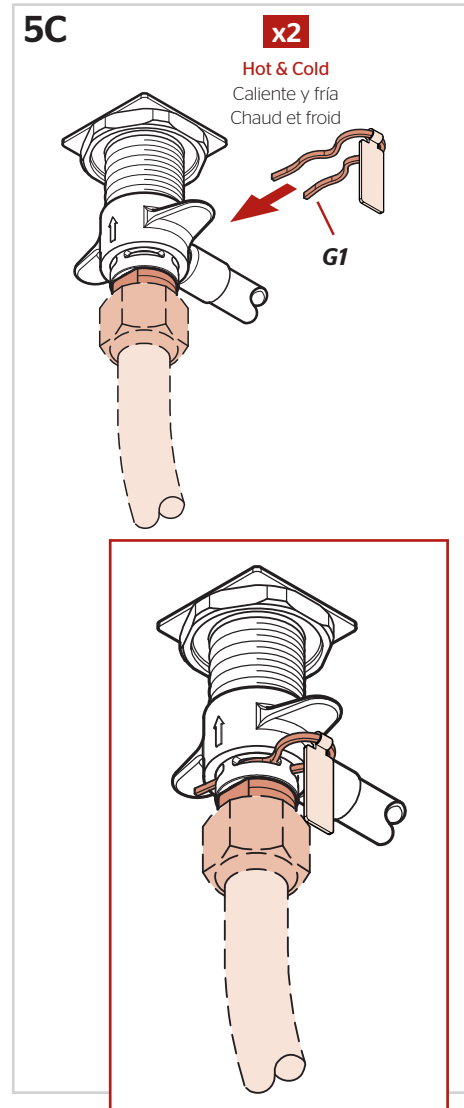
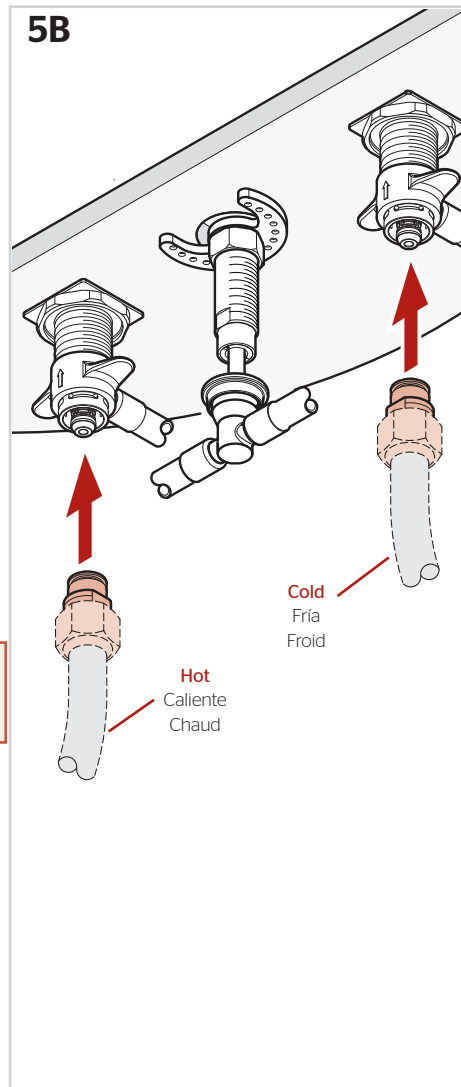
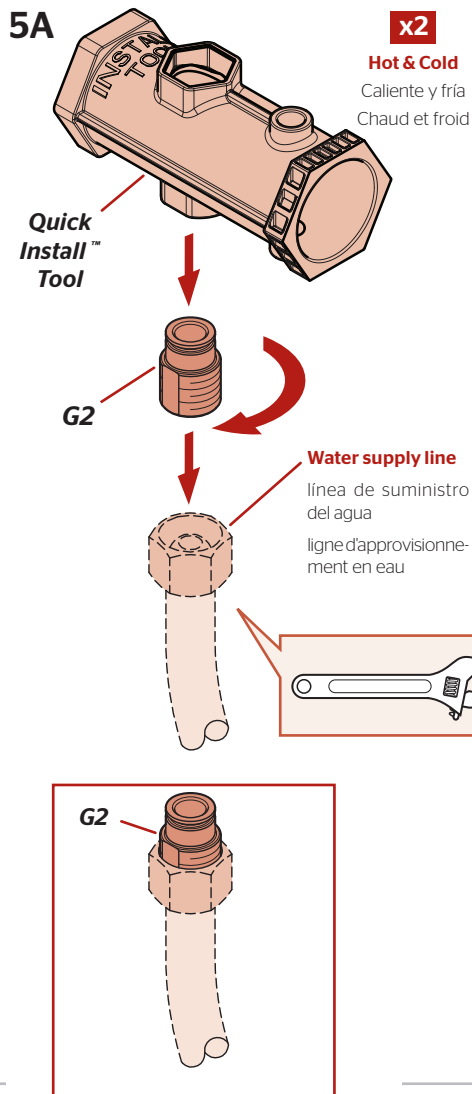

6 Prepare & Install Push & Seal™ Drain

Prepare y instale cuerpo de drenaje Push & Seal™

Préparez & installez le corps de drainage Push & Seal™

No Tools Required for This Step
 No se necesitan herramientas para este paso
 Pas d'outil nécessaire pour cette étape



6A Disassemble Pop-Up

Desensamble el cuerpo de drenaje
 Démontez le corps de drainage

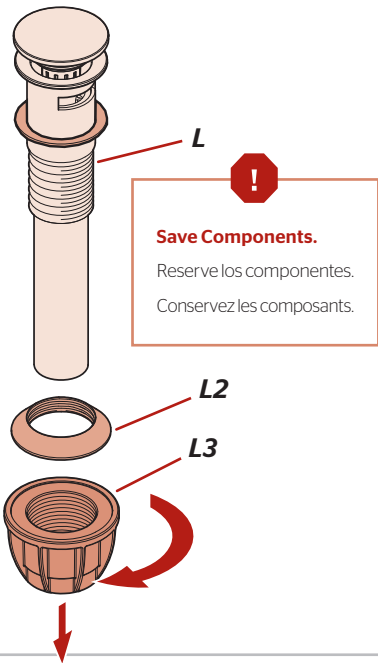

6B

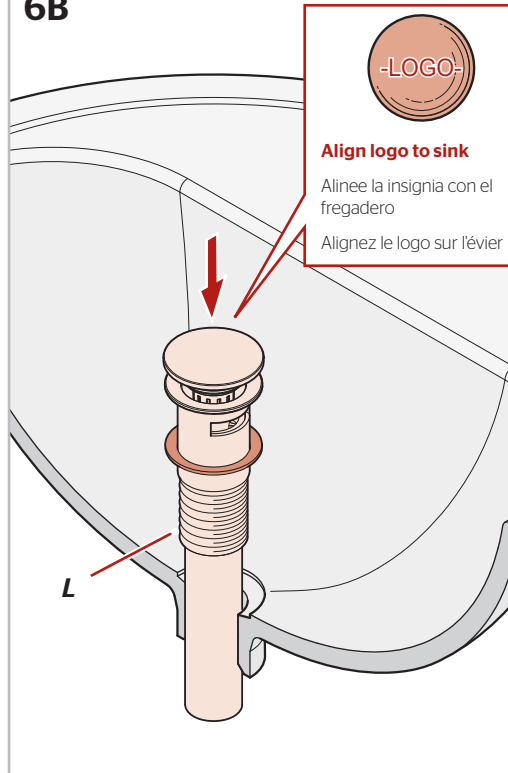

6C

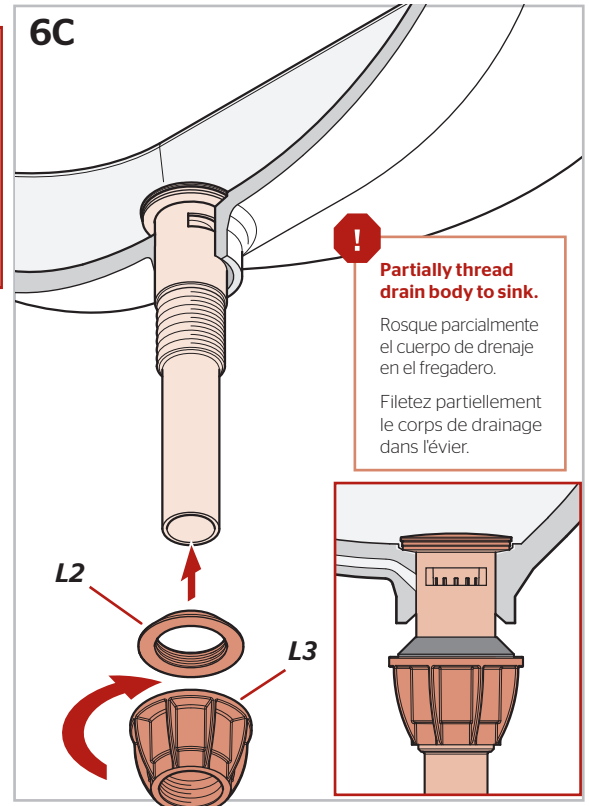

6D

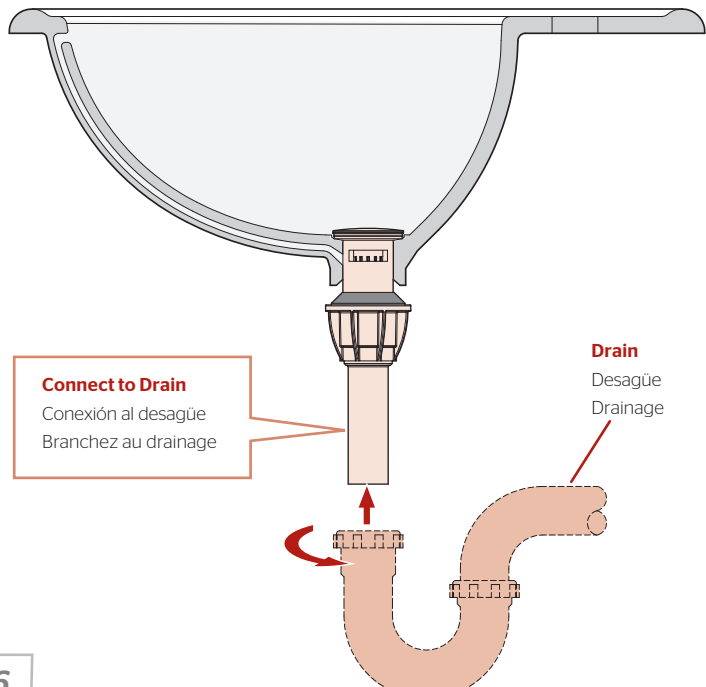

6E

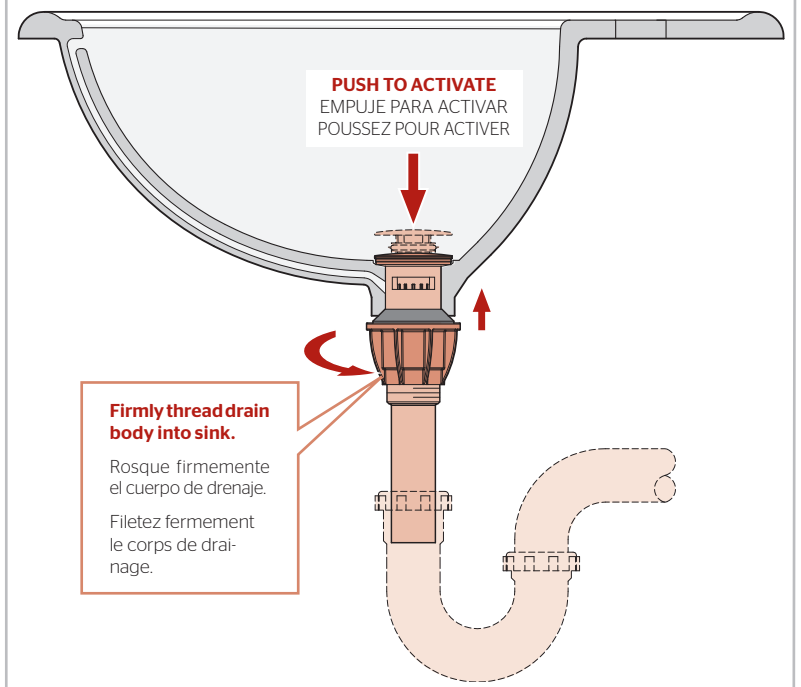

7 Turn On Water & Confirm Proper Installation

Active el suministro de agua y confirme que la instalación está adecuadamente efectuada
Ouvrez l'eau et confirmez que l'installation est adéquate



Check for leaks above and below the sink.

Revise si hay fugas encima y debajo del fregadero

Assurez-vous qu'il n'y a pas de fuite au dessus ou au dessous du lavabo

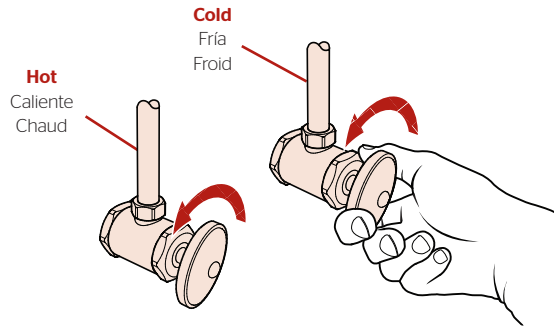

8 Flush the Faucet

Enjuague el grifo
Vidanger l'robinet

8A Remove Aerator Retire el aereador Retirez l'aérateur

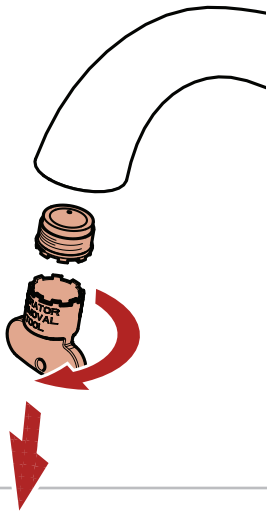

8B

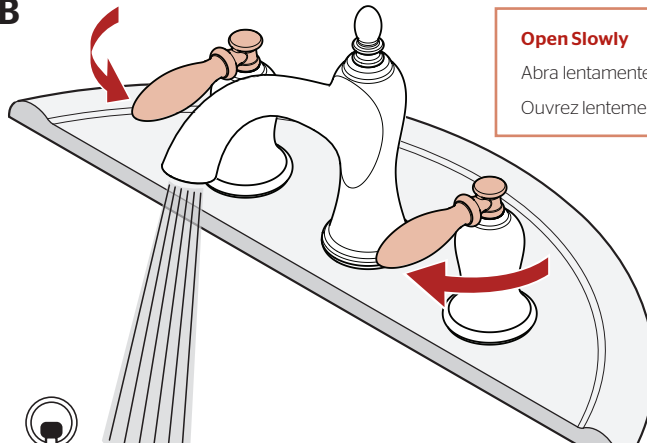

Open Slowly

Abra lentamente

Ouvrez lentement

Allow hot & cold water to run for at least 15 seconds each.

Deje correr el agua caliente y fría durante al menos 15 segundos cada una.

Laissez couler de l'eau chaude et de l'eau froide pendant au moins 15 secondes chacune.

8C

Reinstall Aerator Reinstale el aereador Réinstallez l'aérateur



Hand Tighten

Apriete con la mano

Serrez manuellement

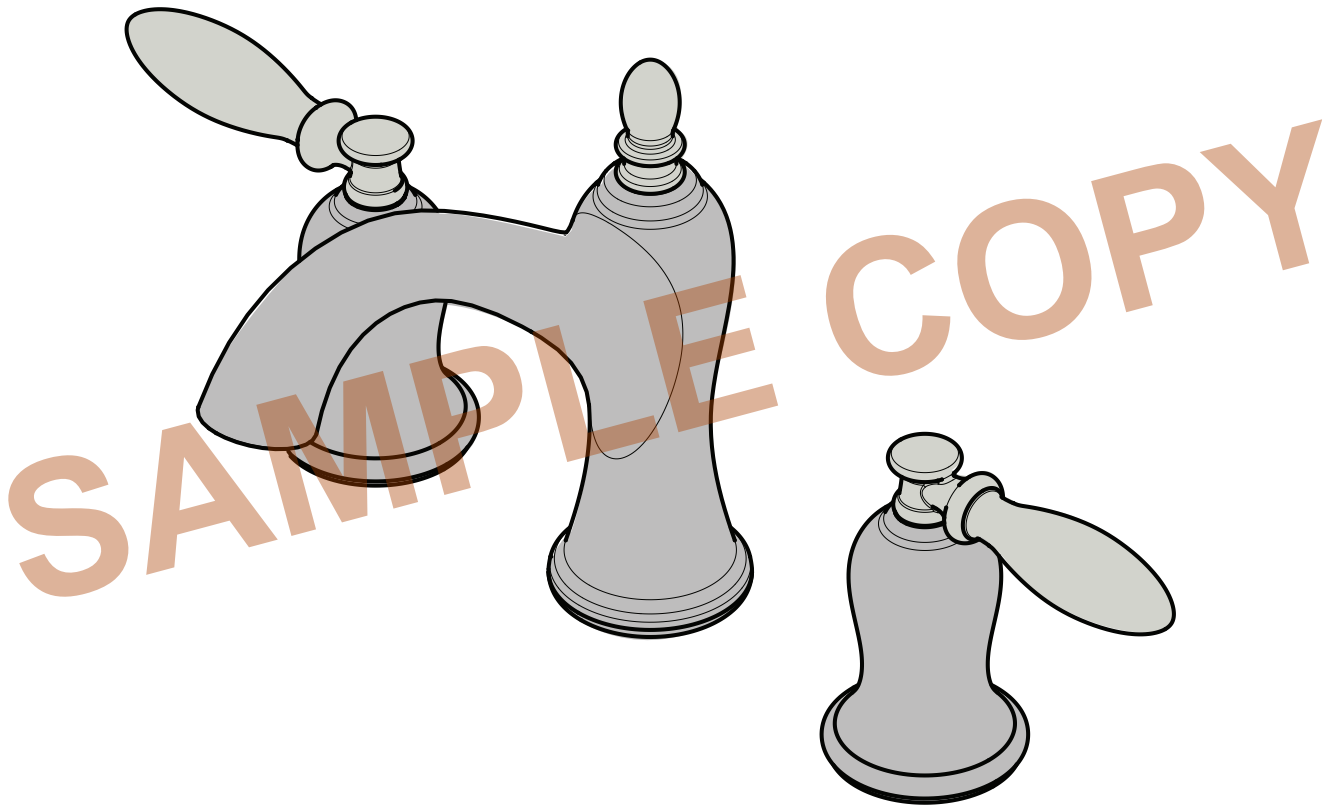

For Additional Installation Help:
Para la instalación adicionales de ayuda:
Pour aider à l'installation supplémentaires:

Pfister

1-800-PFAUCET (732-8238)
pfisterfaucets.com