

Specification Data

Panasonic Ventilation Fan

Panasonic

WhisperGreen™
VENTILATION FAN



FV-05VK3 (50 CFM)

Description

Ventilating fan shall be Low Noise ceiling mount type rated for continuous run. Fan shall be ENERGY STAR rated and certified by the Home Ventilating Institute (HVI). Evaluated by Underwriters Laboratories and conform to both UL and cUL safety standards.

Motor/Blower:

- Enclosed DC brushless motor technology, currently more energy efficient than the minimum ENERGY STAR requirements, rated for continuous run.
- Power Rating shall be 120 volts and 60 Hz.
- Fan shall be UL listed for tub/shower enclosure when used with a GFCI branch circuit wiring.
- Motor equipped with thermal cut-off fuse control.
- Removable with permanently lubricated plug-in motor.

Housing:

- Rust proof paint, galvanized steel body.
- Detachable 4" diameter duct adapter.
- Built-in backdraft damper.
- Expandable extension bracket up to 24".
- Double hanger bar system allowing for ideal positioning.

Grille:

- Attractive design using PP material.
- Attaches directly to housing with torsion springs.

Warranty:

- The factory warranty shall be a minimum of 6 years limited warranty on the motor and 3 years limited warranty on other parts.

Typical Specifications:

Ventilating fan shall be of the ceiling mount, ENERGY STAR rated type, with no less than 50 CFM and no more than 0.3 sone as certified by the Home Ventilating Institute (HVI) at 0.1 static pressure in inches water gauge. Power consumption shall be no greater than 4.3 watts and ENERGY STAR rated with efficiency rating of no less than 12.4 CFM/watt. The motor shall be fully enclosed with brushless DC motor engineered to run continuously. Power rating shall be 120v/60Hz. Duct diameter shall be no less than 4". Fan shall be UL and cUL listed for tub/shower enclosure when used with GFCI branch circuit wiring. Fan shall be California Title-24 compliant.

DC Motor Technology:

- When fan faces static pressure, its speed is automatically increased to ensure that the desired CFM is not compromised, which allows the fan to perform as rated.

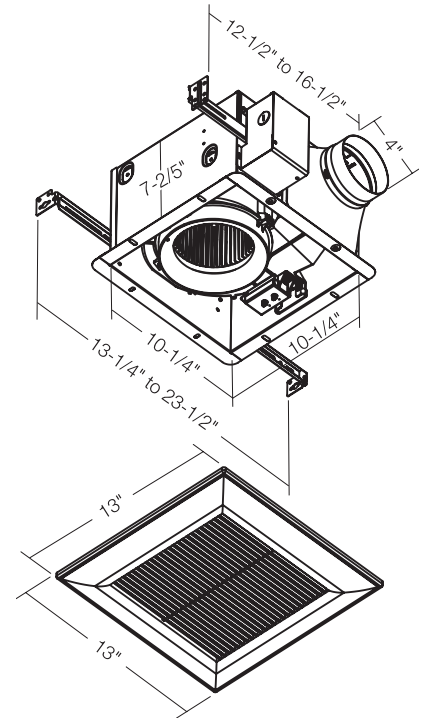

Fan Curve FV-05VK3

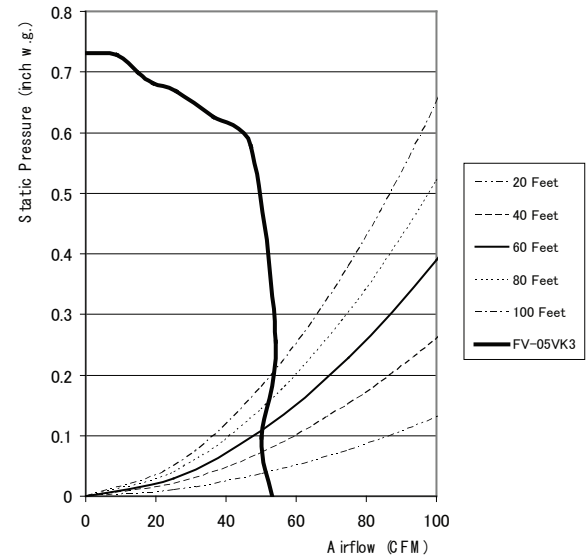

Specifications:		FV-05VK3	
Static Pressure (inches w.g.)		0.1"	0.25"
Air Volume (CFM)		50	54
Noise (sones)		<0.3	0.3
Power Consumption (Watts)		4.3	7.5
Energy Efficiency (CFM/Watts)		12.4	7.7
Speed (RPM)		749	1101
ENERGY STAR Rated		Yes	
Washington State VIAQ Code		Yes	
California Title 24		Yes	

As of 1/11

For Complete Installation Instructions Visit www.panasonic.com/building



Model	Quantity	Comments	Project:
			Location:
			Architect:
			Engineer:
			Contractor:
			Submitted by:
			Date: