

Installation and directions for use

Duct fan, CK



UL VERSION

ÖSTBERG
HEALTHY INDOOR CLIMATE
WITH ENERGY EFFICIENT VENTILATION

This directions for use contains following product: Duct fan CK
Read and save these directions.

CAUTION! FOR GENERAL VENTILATION USE ONLY. DO NOT USE TO EXHAUST HAZARDOUS OR EXPLOSIVE MATERIALS AND VAPORS.

DESCRIPTION

- The fan is used for transportation of "clean" air, meaning not intended for fire-dangerous substances, explosives, grinding dust, soot, etc.
- The fan is equipped with an asynchronous external rotor induction motor with maintenance-free sealed ball-bearings.
- To achieve maximum life length for installations in damp or cold environments, the fan should be operating continuously.
- The fan can be installed outside or in damp environments. Make sure that the fan-house is equipped with drainage.
- All CK-fans are as standard, single phase 110-127V 60 Hz .
- The fan can be installed vertically or horizontally.

INSTALLATION

- The fan has rotating parts, therefore safety precautions should be exercised during installation, operation and maintenance. Tighten all screws before operation unit. **USE HAND PROTECTION AND STAY CLEAR OF SHARP EDGES.**
- The fan must be installed according to all local and national codes and the air direction label on the fan.
- The fan must be connected to duct or equipped with a safety grill.
- The fan should be installed in a safe way not to cause vibrations or risking the fan to fall off.
- A wiring diagram is applied on the inside of the junction box.

WARNING! TO REDUCE THE RISK OF FIRE, ELECTRICAL SHOCK OR INJURY TO PERSONS, OBSERVE THE FOLLOWING:

- Use this unit only in the manner intended by the manufacturer. If you have any questions, contact your manufacturers representative.
- Before servicing and cleaning unit, switch power off at service panel and lock the service disconnecting means to prevent power from being switched on accidentally. When the service disconnecting means cannot be locked, securely fasten a prominent device, such as a tag, to the service panel.
- Installation work and electrical wiring must be done by qualified person(s) in accordance with all applicable codes and standards, including fire-rated construction.
- When cutting or drilling into the wall or ceiling, do not damage electrical wiring or other hidden utilities.
- Ducted fans must always be ventilated to the outdoors.
- Do not install this unit above a tub or a shower, if it's not marked as appropriate for the application.
- Never place a switch where it can be reached from a tub or shower.

OPERATION

Before starting, make sure that:

- the fan is installed and electrically connected in the correct way to ground..
- the current does not exceed more than +5% of what is stated on the label.
- No foreign object are placed in the fan and no noise appears when starting the fan.

MAINTENANCE

WARNING! TO REDUCE THE RISK OF FIRE, ELECTRICAL SHOCK OR INJURY TO PERSONS, OBSERVE THE FOLLOWING:

- Use this unit only in the manner intended by the manufacturer. If you have any questions, contact your manufacturer's representative.
- Before service and cleaning of the unit, switch off the power at the service panel and lock the service disconnecting means to prevent power from being switched on accidentally. If the service disconnecting means cannot be locked, securely fasten a prominent device, such as a tag, to the service panel.
- Consider the weight of the fan when removing larger fans to avoid jamming and contusions.
- The fan must be cleaned when needed, at least once per year to maintain the capacity and to avoid unbalance which may cause unnecessary damages on the bearings.
- The fan bearings are maintenance-free.
- When cleaning the fan, high-pressure cleaning or strong dissolvent must **not** be used. Cleaning should be done without dislodging or damaging the impeller.
- Make sure that there is no noise from the fan.

If repair must be made to the product, it has to be performed by a qualified maintenance person.

FAULT DETECTION

1. Make sure that there is tension to the fan.
2. Cut the tension and verify that the impeller is not blocked.
3. Check the thermo-contact/motor protector. If it is disconnected the cause of overheating must be located and taken care of.
4. CK is equipped with **automatic** thermo-protector which resets automatically when the motor is back in normal working temperature.
5. Make sure that the capacitor is connected according to the wiring diagram.
6. If the fan still does not work, the first thing to do is to change the capacitor.
7. If nothing of this works, contact your fan supplier.
8. If the fan is returned to the supplier, it must be cleaned, the motor cable undamaged and a detailed nonconformity report enclosed.

WIRING DIAGRAMS

Wiring diagram no: 4040076

For CK-fans type:

CK 100 C, CK 125 C, CK 150 B, CK 150 C, CK 160 B, CK 160 C, CK 200 A, CK 200 B, CK 250 A, CK 250 C, CK 315 B, CK 315 C, CK 4" C, CK 5" C, CK 6" B, CK 6" C, CK 8" A, CK 8" B, CK 10" A, CK 10" C, CK 12" B, CK 12" C.

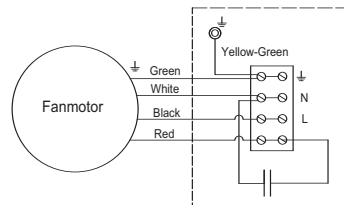

Wiring diagram no: 4040077

For CK-fans type:

CK 100 A, CK 125 A, CK 4" A, CK 5" A.

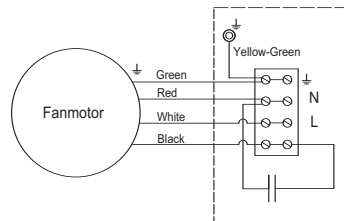

ASSEMBLY INSTRUCTION

Mounting bracket kit for easy suspension of CK contents:
 1. 2 pcs mounting bracket
 2. 4 pcs screws



The brackets can be mount horizontal everywhere around the joint of the fan. For right distance between the brackets, see the dimension table **(B)** and the distance from the joint to screw-hole **(C)**.

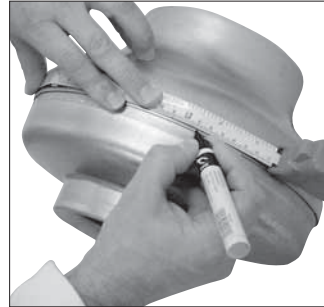

1. Mark the measure of **B** on the fan for the placement of the mounting brackets.

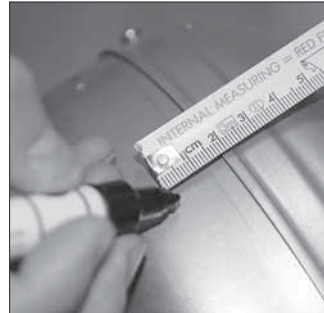
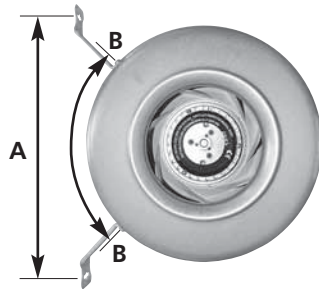

2. Mark the measure of **C**. Start from the joint of the fan.

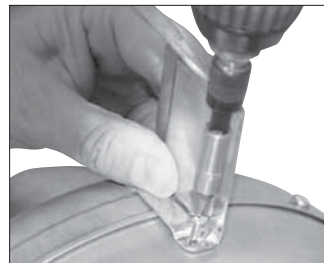

3. Fasten the mounting brackets with the self-drilling screws.

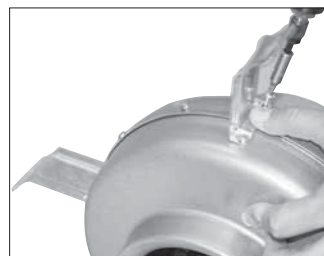

Fan size inch/mm	A	B	C
	+0,08"/+2	+0,08"/+2	+0,04"/+1
4" 100	10,91"/277	7,28" 185	0,70" 18
5" 125	10,91"/277	7,28" 185	0,59" 15
6"B 150	11,78"/299	8,27" 210	0,70" 18
6"C 150	12,72"/323	9,77" 248	0,67" 17
8" 200	12,72"/323	9,77" 248	0,70" 18
10" 250	12,72"/323	9,77" 248	0,70" 18
12" 315	13,79"/350	10,83" 275	0,67" 17

INSTALLATION INSTRUCTIONS

Installation instructions for exhaust systems for duct fan, type CK.

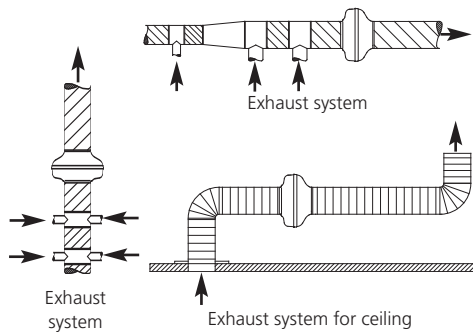

1. Mark the measure of **A** on the wall or roof and then fasten the fan.



2. Put together the ducts and the fan.

Installation with duct clamps for duct fan CK.

Duct clamp, type MK is made of pre-galvanized steel and is rubber-lined to seal connection and absorb vibrations. The clamp allows the fan to be easily removed for inspection and cleaning.

Available in sizes: Ø 4, 5, 6, 8, 10 and 12 inch.

To be use for waterproof connection.

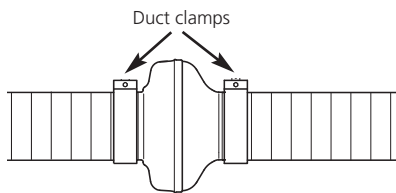

3. Strap the duct clamps on each side of the fan with the screws.



OSTBERG AMERICAS INC.

72-972 Highway 312 • Englishtown, NS • B0C 1H0 • Canada
Toll free number 1-866-OSTBERG (678-2374) • Toll number 902 295 2066
Fax number 902 295 2161
www.ostberg.com