

Features

- Solid brass rough-in valve included.
- 8" rain shower head.
- 3-way concealed diverter (3 water outlets).
- Pressure balance cartridge.
- Cermaic disc technology.
- Sleek hand shower.
- Tub spout included.
- 24" sliding rail included.
- 1/2" NPT inlets and outlets (compatible with US plumbing connections)



Installation

- Wall mounted installation.

Included Pieces

- 16" shower arm with flange. (Remer 343-40US-CR)
- 8" rain shower head. (Remer 356MD20)
- 3-way shower diverter with rough-in valve. (Remer N93US-CR)
- Multi-function hand shower. (Remer 317MR)
- Flexible shower hose. (Remer 333CNX150-CR)
- 24" sliding rail. (Remer 311D)
- Water connection. (Remer 309LUS-CR)
- Tub spout. (Remer 91M-CR)

Nameek's One-Year Limited Warranty

See website for warranty information details.

Color/Finish Details

Color	Code	Description
	CR	Polished Chrome

Shower Arm

Remer 343-40US-CR

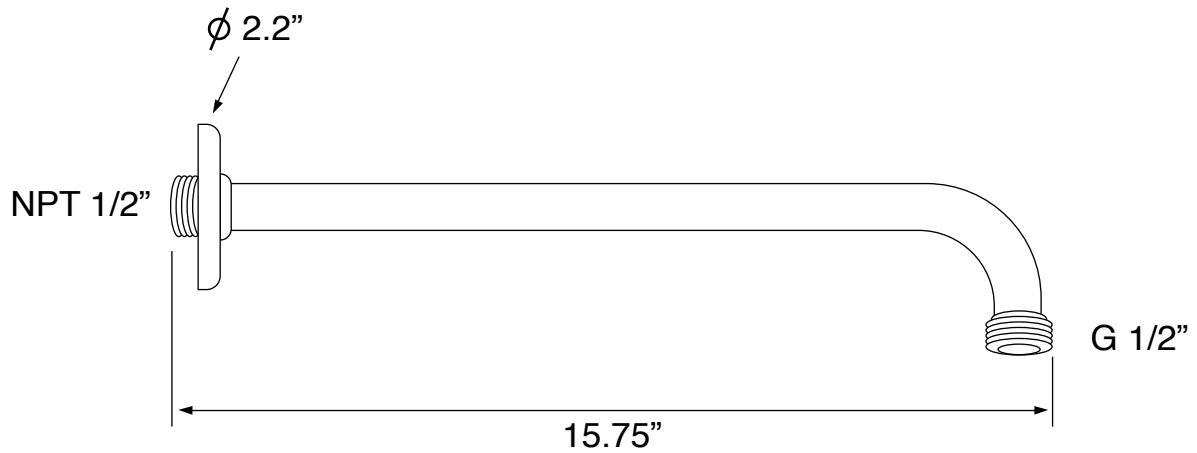

Rain Shower Head

Remer 356MD20

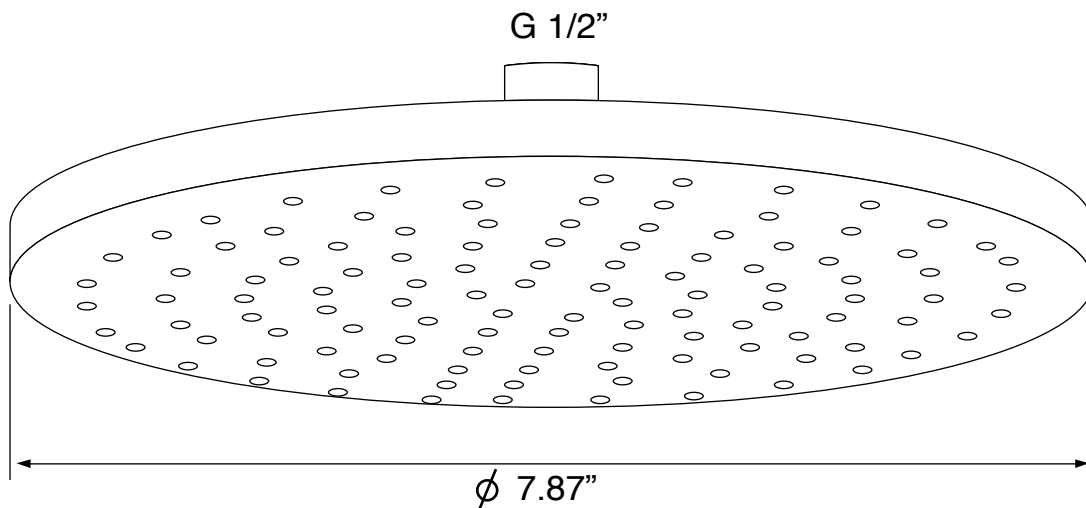

Shower Valve (Trim + Rough-in Valve)

Remer N93US-CR

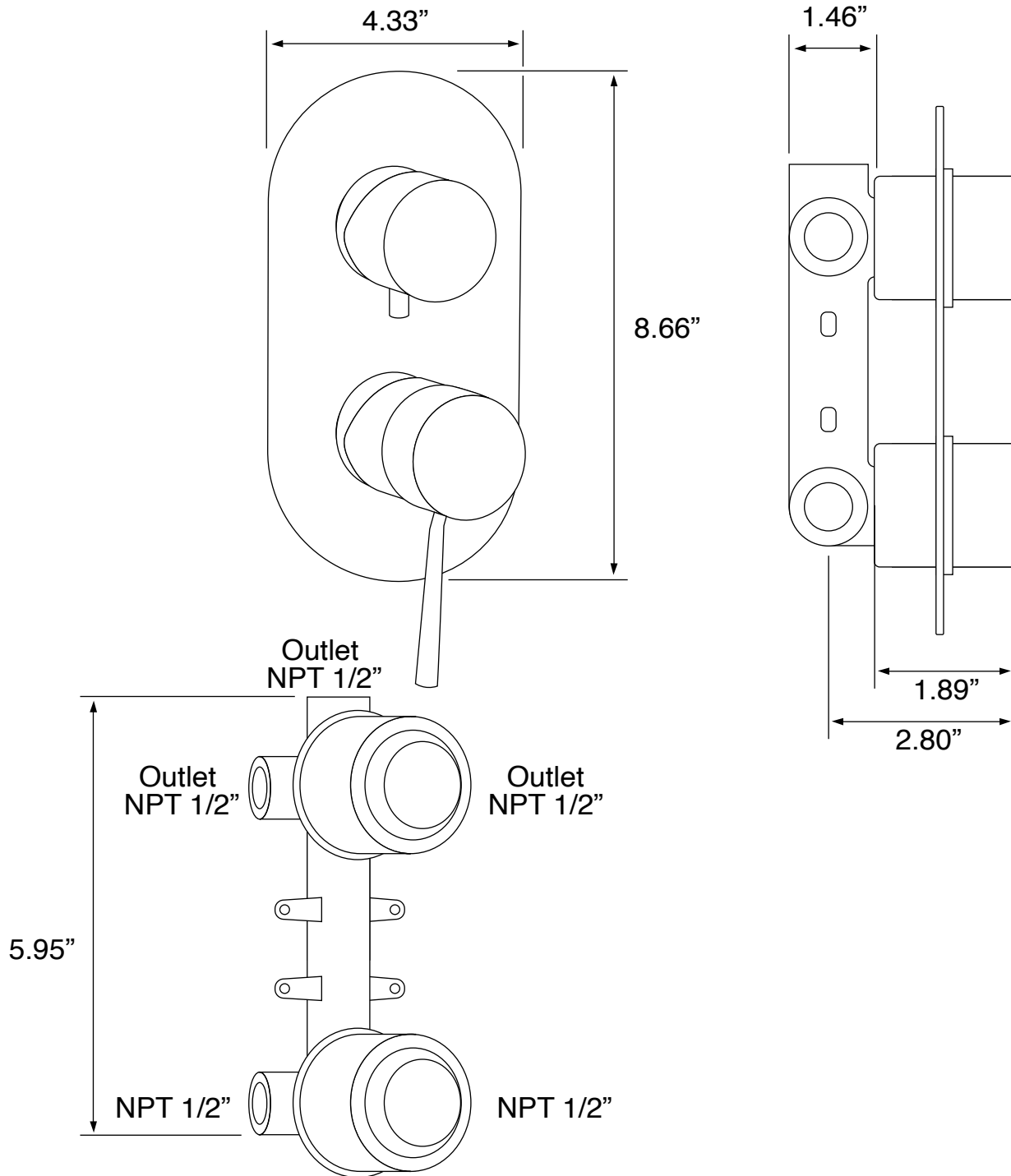

Hand Shower

Remer 317MR

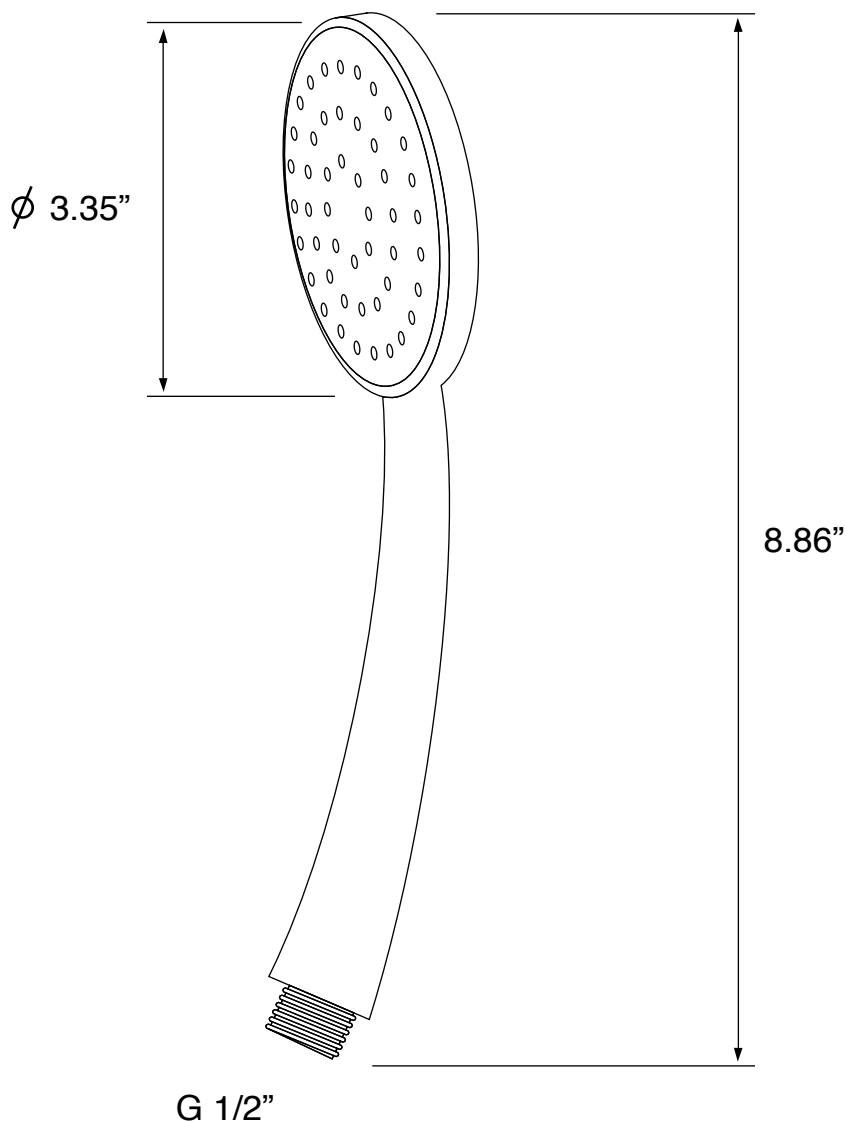

Sliding Rail

Remer 311D

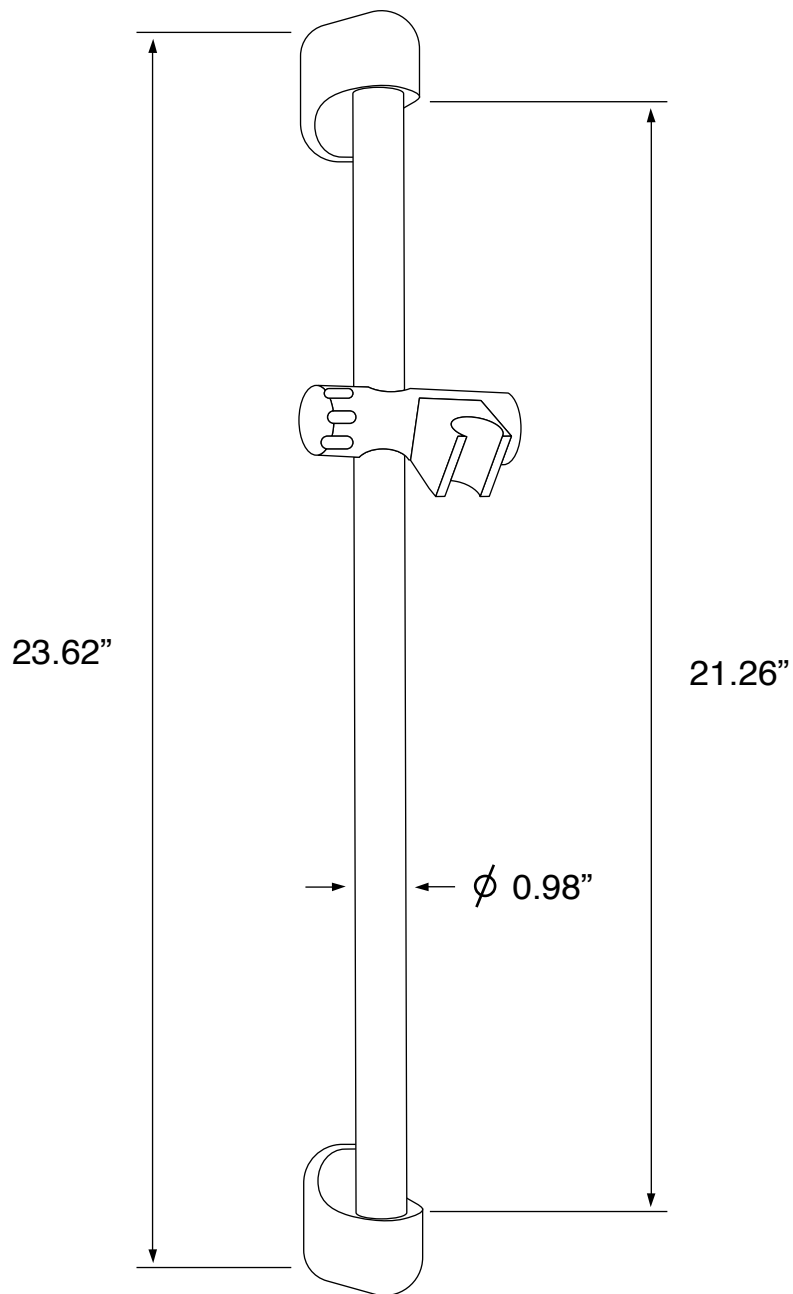

Tub Spout

Remer 91M-CR

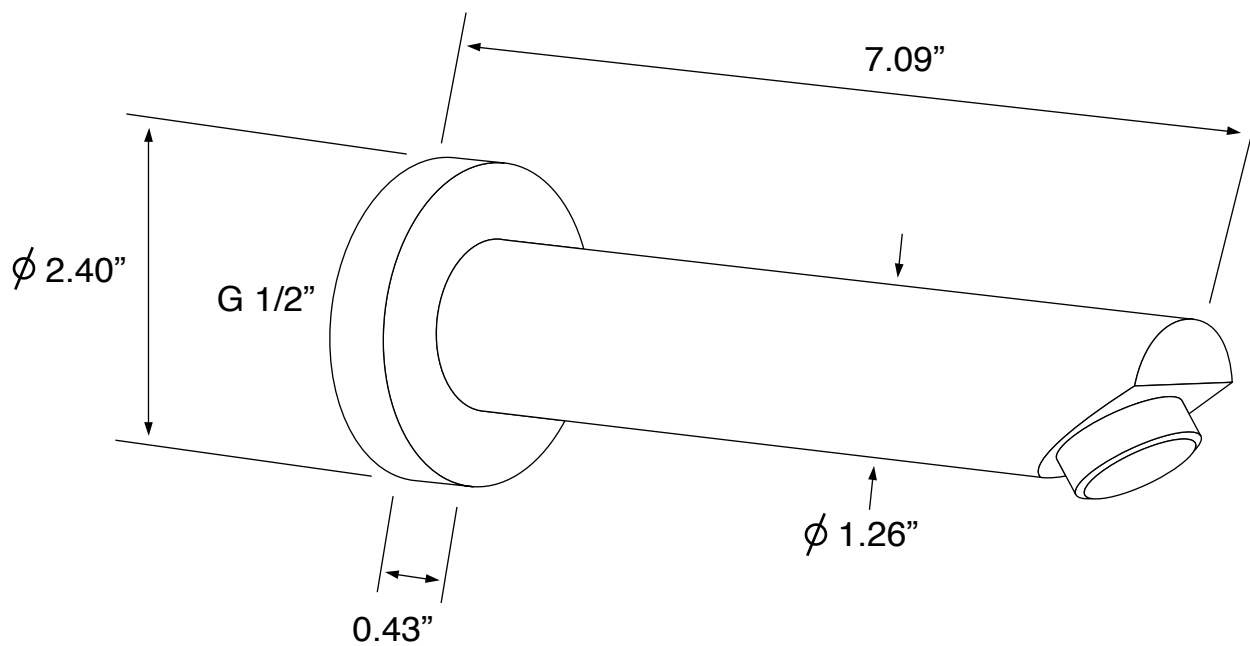

Water Connection

Remer 309LUS-CR

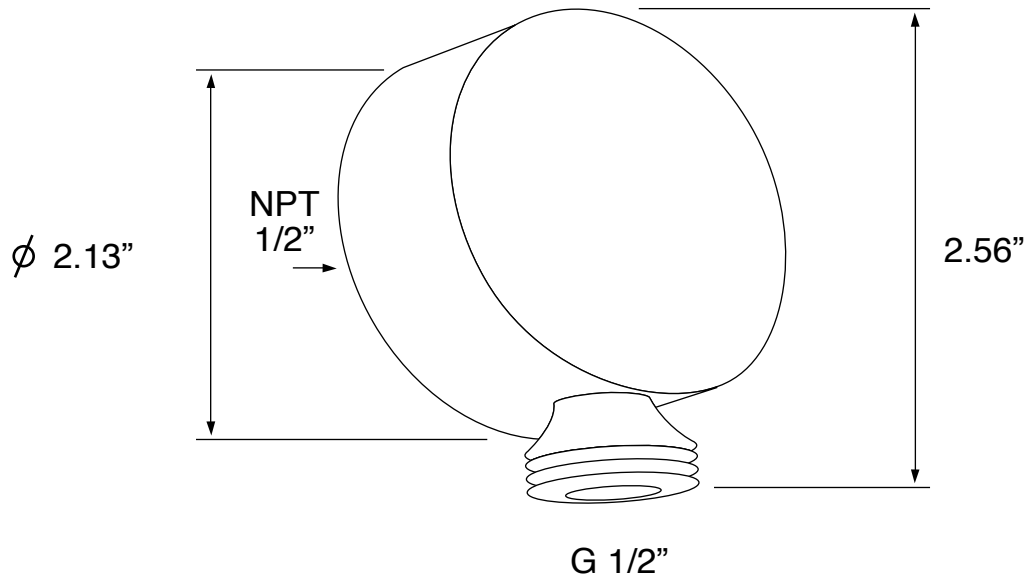

Shower Hose

Remer 333CNX150-CR

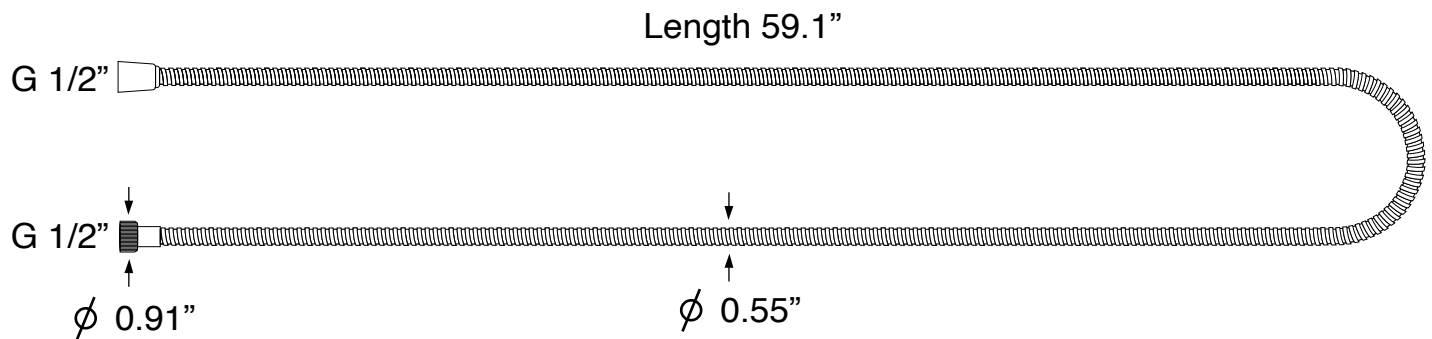

Technical Information

Shower head size:	7.87"
Shower head type:	Rain
Pivoting shower head:	Yes
Shower arm length:	15.75"
Rough-in included:	Yes
Material:	Brass ABS
Cartridge type:	Pressure balance Ceramic disc technology
Hand shower functions:	Wide

Notes

This item is recommended to be installed by a licensed plumber or professional only. Please ensure to observe all local and building code requirements. Shut off water supply prior to installation.

Includes mounting hardware.