

Installation and Operation Manual

Effective March 6, 2023



Cosmopolitan Collection

Mineral Composite Tubs
Freestanding Soaker and Airbath Systems

Installer: This booklet must be given to the product owner.
Please include important information below:

Distributor Name
Model Number
Manufacturer's Date
Serial / Registration Number

Owner's Manual & Installation Guide

Thank you for purchasing an MTI Baths product.

The instructions in this booklet will provide you with the information needed to install and maintain this unit. The ease of cleaning and the elegant look will provide you with many years of pleasure. This information is also available on mtibaths.com.

Our customer service department is available to answer any additional questions you may have pertaining to installation and care of your MTI product. Please call **800-783-8827** to speak to our Service Department or email service@mtibaths.com.



Table of Contents

Important Safety Instructions	4
Installation Instructions	5-10
Tubs	6
Air Bath	8
Air Bath Operating Instructions	
Keypad and Remote Control.....	11
Care and Cleaning Instructions	12
Troubleshooting.....	13
Residential Warranty.....	14-15
Commercial Warranty.....	16-17



Important Safety Instructions

This manual contains information and instructions for proper operation and maintenance of the MTI bathtub. Failure to follow these instructions could result in personal injury, electrical shock or fire.



INSTRUCTIONS PERTAINING TO RISK OF FIRE, ELECTRIC SHOCK, OR INJURY TO PERSONS.

WARNING: When using electrical products, basic precautions should be followed including the following:

- Do not permit children to use this unit unless they are closely supervised by an adult at all times. Supervision is also required when bath is used by an elderly or handicapped individual.
- Never leave a full or filling bath unattended.
- Use this unit only for its intended use as described in this manual. Do not use attachments not recommended by the manufacturer. Never drop or insert any object into any opening.
- The water in a bath should never exceed 40° C (104° F). Water temperatures between 38° C (100° F) and 40° C (104° F) are considered safe for a healthy adult. Use time should be limited to approximately 10 minutes, followed by a shower to cool down. Longer exposures may result in hyperthermia, which can be fatal. The symptoms of this condition are nausea, dizziness and fainting. Lower water temperatures are recommended for extended use (exceeding 10 - 15 minutes) and for young children.
- Since excessive water temperatures have a high potential for causing fetal damage during the early months of pregnancy, pregnant or possibly pregnant women should limit water temperatures to 38° C (100° F).
- The use of drugs or alcoholic beverages before or during bathing may lead to unconsciousness with the possibility of drowning. Never use the bath while under the influence of alcohol, anticoagulants, stimulants, antihistamines, vasoconstrictors, vasodilators, hypnotics, narcotics or tranquilizers.
- Persons using medication should consult a physician before using a bath since medication may induce drowsiness while other medications may affect heart rate, blood pressure and circulation.

CAUTION: Do not use harsh abrasives or solvents for cleaning this unit.

DANGER: To reduce the risk of injury, enter and exit the bath slowly.

WARNING: Never operate electrically connected devices in or within 5' of the bath. Never drop or insert any object into any opening within the bath.

DANGER: Risk of electric shock. Connect only to circuits protected by a Ground Fault Circuit Interrupter (GFCI). Such a device should be installed by a licensed electrician and should be tested on a regular basis (at least monthly). To test the GFCI push the TEST button. The GFCI should interrupt the power. Push the RESET button and the power should be restored. If the GFCI fails to operate in this manner there is the possibility of an electric shock. DO NOT USE. Disconnect the unit and have the problem corrected by a qualified service technician. To avoid the possibility of personal injury and discoloration of the surface material, the inlet water temperature should not exceed 60° C (140° F).

DANGER: Disconnect power before servicing.

INSTALLER/OWNER BEARS ALL RESPONSIBILITY TO COMPLY WITH ALL STATE AND LOCAL CODES WHEN INSTALLING THIS PRODUCT.

SAVE THESE INSTRUCTIONS



Installation Instructions

Read all instructions before installing tub. MTI recommends using a professional installer for this product. Installer/product owner is responsible for complying with all state and local codes. Handle this tub with extreme caution. Dropping this product, even from several inches, may cause cracking and permanent damage. Rubber gripped gloves may make it easier to handle the mineral composite bath.

WARNING: Certain cleaning products will permanently damage the mineral composite surface. Read product label carefully before using any cleaning product. Never use anything abrasive, aerosol sprays or any product that is described as “scrubbing bubbles.” Please see ‘**Care & Cleaning Instructions**’ on pg. 12.

Before Installing

- Inspect tub thoroughly.
- Damage from shipping or delivery must be reported to carrier immediately. **Do not install damaged tub. MTI is not responsible for damage occurring during transit.**
- Factory defect must be reported to factory before tub is installed. Defects or damage claimed after installation will be excluded from warranty.
- Measure tub on site carefully. Specifications are subject to change without notice. MTI is not responsible for any preparatory labor or materials.

Please note: Blemishes, air holes or casting marks on the underside of the bath are not considered defects and do not affect the performance or quality of the bath.

Always protect the tub from construction damage by using a protective cover. Damage, including chips and scratches incurred at the jobsite are excluded from warranty, but may be repaired by a qualified technician at the owner’s expense. Do not stand in the tub or store materials in the tub during construction. Tubs are intended for indoor use. Tubs are warranted for indoor installation in a climate controlled environment only.

Never leave a full or filling bath unattended.

Warranty Cards & CERTIFICATION Labels

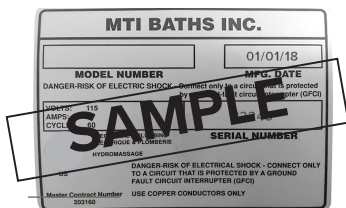

IMPORTANT: Locate and note the serial number on the cover of this manual for any future service needs.



Drain Rough-In Dimensions for Freestanding Tubs with Integral Overflow

MTI mineral composite freestanding tubs may be installed with the overflow positioned in the rear or the front of the tub, however, rough-in dimensions provided below are from center of drain to the top outside edge as shown on the product specification sheet. See product specs for line drawing of each tub model.

Model No.	Measurement X
400	16"
401	15½"
402	8¾"
403	15½"
404	16"
405	9"
406	8"

Model No.	Measurement X
407	16⅓"
408	16"
409	19¾"
550	15½"
552	8¾"
553	12"

The toe tap drain kit for these tub models includes a straight PVC fitting for weld adhesive connection to the drain pipe directly underneath the tub drain. A 6" brass tailpiece is available, sold separately. When installing to brass, use the provided brass nut in lieu of the PVC fitting to secure the assembly to the threaded drain body.¹

Distance from the bottom of the drain to the finished floor will vary with each tub model. Adjust leveling feet to ensure tub is level. Before trimming rough-in pipe, measure the distance from the bottom of the tub to finished floor. Weight of the tub should not rest on the drain; damage may result.¹

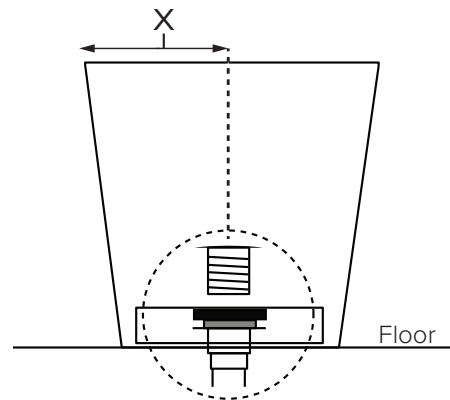

¹ MTI does not warrant leaks or damages associated with improper drain installation and will not be responsible for any costs related to improper installation. If you need assistance, please call the MTI Service Department at 800.783.8827.

Installation Instructions – Tubs with Integral Overflow

The integral overflow tubs by MTI Baths require only the waste to be installed. The P-trap will be located directly below the drain (see tub specification sheet). The tub comes equipped with a toe tap drain and PVC drain fitting.

ⓘ **MTI Recommends using clear 100% silicone sealant. Do Not use plumber's putty.**

With Access From Ceiling Below

1. Install drain on tub using clear silicone under waste flange and both sides of the rubber gasket. Use a small amount of clear silicone on the threads of the PVC drain fitting to act as a thread sealant. Tighten until it seats, plus one half turn.

⚠ **Do not overtighten and do not exceed 7 ft-lbs maximum. Product damage will occur.**

2. Adhere tub to a level, finished floor using ½-inch bead of clear silicone¹. Align tub drain with box-out in floor.²

3. Finish drain installation from below. Use PVC cement to connect PVC drain fitting to P-trap.

4. Allow time for silicone to cure and water test for leaks. Refer to product label for details.

Without Access From Below

1. Stub out drain and P-trap with 1½ schedule 40 PVC pipe at least 1" above finished floor. Because the height will vary slightly from tub to tub, box out around the pipe to allow trimming this pipe below grade upon installing the MTI supplied fitting. The fitting is approximately 3" in diameter.

2. Determine gap between underside of tub (at drain) and the floor. Shorten 1½ inch pipe to allow for the PVC fitting and gasket above the finished floor. Glue fitting to pipe with PVC cement; remember to allow for the thickness of the rubber gasket. Make sure that the top of the flange is level.

3. Secure rubber gasket to top of fitting with clear silicone. Apply bead of silicone on top of gasket. Use silicone on the threads of PVC drain fitting to act as a thread sealant.

4. Adhere tub to a level, finished floor using ½-inch bead of clear silicone¹. Align tub drain with rough-in.²

5. Place a small bead of silicone under waste flange; thread into PVC drain fitting. Tighten until it seats, plus 1-quarter turn.

⚠ **Do not overtighten and do not exceed 7 ft-lbs maximum. Product damage will occur.**

6. Allow time for silicone to cure and water test for leaks. Refer to product label for details.

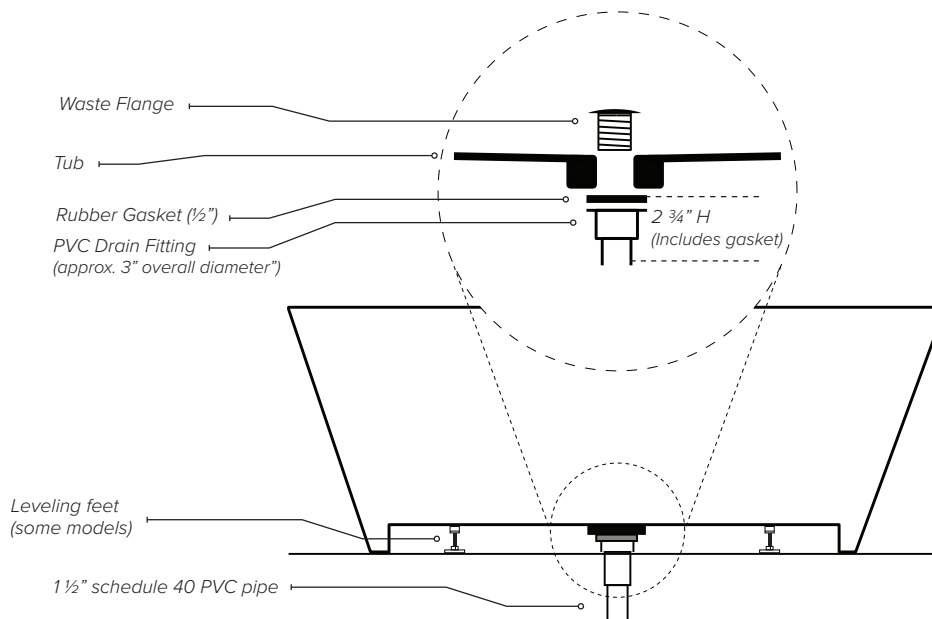

¹ Tub must be level in order to drain properly. Do not adhere tub to a floor that is not level. Some models come equipped with leveling feet to adjust for a finished floor that is not level. Fill any gaps with color-matched caulk.

² MTI does not warrant leaks or damages associated with improper drain installation and will not be responsible for any costs related to improper installation. If you need assistance, please call the MTI Service Department at 800.783.8827.



Installation Instructions – Airbath

To maintain optimal performance and easy operation, the following conditions must be met.

Electrical installation instructions

See Important Safety Information on pg. 4 of this manual and Electrical Specifications below. This circuit must be connected to a supply that is protected by a ground fault circuit interrupter (GFCI). Such a GFCI should be provided by the installer and accessible for testing on a routine basis.

Testing The GFCI:

Push the **TEST** button. The GFCI should interrupt power.
Push the **RESET** button. Power should be restored.

WARNING: If the GFCI fails to operate in this manner, there is a ground current flowing, indicating the possibility of electric shock. DO NOT use this unit. Disconnect the unit and have the problem corrected by a qualified service representative before using.

Every MTI air blower is supplied with a 29” grounded cord and NEMA plug to be plugged into a grounded receptacle*. **Do not remove this plug.** If a wall mount switch is desired to control use of the unit, the switch should control the receptacle. **Under no circumstance should you alter the provided supply cord.**

Before servicing unit, shut off all electrical outlets as more than one outlet may be energized.

*Air blowers do not require a bonding conductor.

Electrical Specifications

Air Blower.....9.5 AMP

System components supplied with MTI tubs intended for installation within the U.S. & Canada are limited to 110V. Check the order details when installing outside of these territories.

Airbath Installation Instructions

Read all installation instructions before beginning install.

The blower and check valve must be remotely located within 8’ of the tub (**Fig. 1, pg. 10**). A common location is a closet or cabinet. The check valve must be 2” above the height of the top of the tub rim and can be mounted to the framing or wall with pipe hanger, pipe clamp, metal straps or wire ties. MTI Cosmopolitan Collection airbaths come with a remote control and optional keypad.

Blower Installation

- Installation location of the blower must be properly ventilated to keep it from overheating and climate controlled to avoid the impact of cold ambient air on the performance of the blower and guard against humidity that can be corrosive to the electronics.
- 14” x 16” access must be provided for future servicing.
- The blower requires approximately 2ft³ of space and 1” x 4” vent for proper circulation. Do not use insulation within 8” of the blower, and never wrap insulation around the blower as this will cause the equipment to fail.
- Secure blower using wood screws through the mounting feet.
- Within 2 ft. of the blower, there must be a GFCI electrical outlet on a 110 VAC that is the recommended size for the air system. The GFCI outlet must be accessible for future servicing.

Note: MTI does not recommend locating the blower more than 8’ from the tub to prevent heat loss from the blower to the tub. 1” schedule 40 PVC pipe and pipe insulation may be used to help retain the warmth of air from the blower.

Continued on next page...

Installation Instructions – Airbath

To maintain optimal performance and easy operation, the following conditions must be met.

Check Valve And Airline Installation

- The remote check valve **MUST** be mounted at least 2" above the top rim of the tub. Use 1" PVC flexible pipe or rigid schedule 40 to connect the remote check valve to the manifold (factory installed underneath the tub) or to the gray air hose at the manifold. Connect the check valve to the blower using the gray hose. Make sure ring clamps are secure on both end of the gray hose(s).
- **NOTE:** Depending on remote check valve location and site conditions, the air hose that is attached to the manifold can remain within the pedestal or run under the floor to connect to the roughed in airline in the floor, or exit the tub through the side of the pedestal base for an above-the-floor airline installation. When running gray hose under the floor, use a heat resistant adhesive to secure connection from hose to pipe and use care not to crush or restrict the airflow in the line in any way.

IMPORTANT: Side exit from the pedesal would require onsite drilling through the pedestal and should only be considered when there is no subfloor access to run the airline. MTI does not recommend an above-the-floor airline, unless the tub and outlet in pedestal are very close the wall or the airline can be concealed with nearby or surrounding cabinetry. Onsite modification to the pedestal is performed at the risk of the installer. MTI does not pre-drill the pedestal base for side exit (**Photo A**).

Water Sensor, Remote Control & Keypad Installation

- The water sensor wire, factory installed to posts under the tub on either side of the tub drain (**Photo B**), will connect to a port on the side of the blower (**Fig. 2, pg. 10**). Do not attempt to remove the sensor wires from the tub. To extend this wire, splice in 18 gauge, low voltage wire. Be sure to save the two pin connector to allow connection to the blower.
- Use the 12" ethernet cable to connect the radio frequency (RF) receiver module to the blower (**Fig. 2, pg. 10**). The keypad comes synchronized to the blower from the factory. Synchronization instructions are provided with the remote control.
- The keypad is optional and can be mounted convenient to the bather or in an inconspicuous location to use as a secondary option for system control. Use the 6' ethernet cable to connect keypad to secondary jack on radio receiver module (**Fig. 2, pg. 10**).

Test

- Plug the blower into the outlet and test for operation. After the airbath is turned off and water drains from the tub, the LED light on the keypad will flash continuously, indicating the purge cycle is activated.
- **NOTE:** All air baths are equipped with an automatic drying cycle. Approximately 7 minutes after the bath is drained, the blower will turn on for 1-2 minutes. This drying cycle cannot be cancelled. Any attempt to cancel this cycle resets the countdown timer. When the purge cycle is complete, the LED light will cease flashing.

Photo A

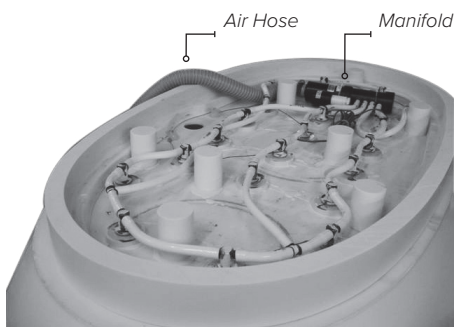
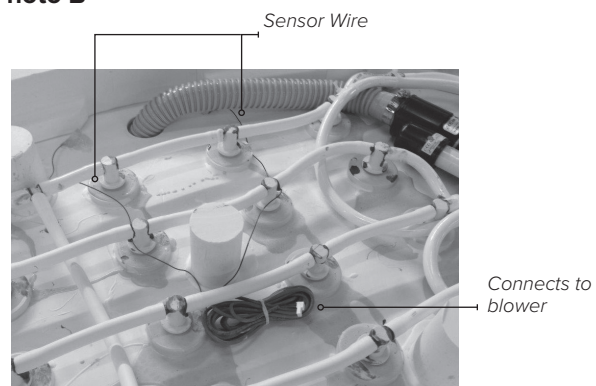

Photo B



Airbath Installation (continued)

Remote Installation Of Air Blower

The following illustration is referenced in the instructions on pg. 8.

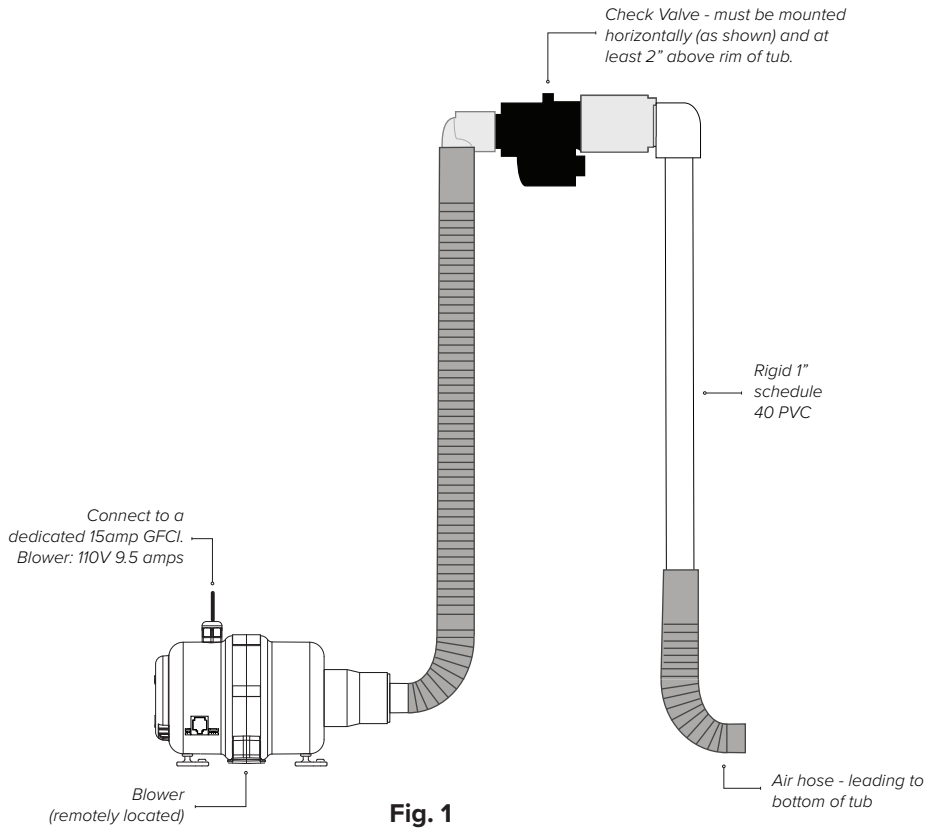

Remote Installation Of Air System Components

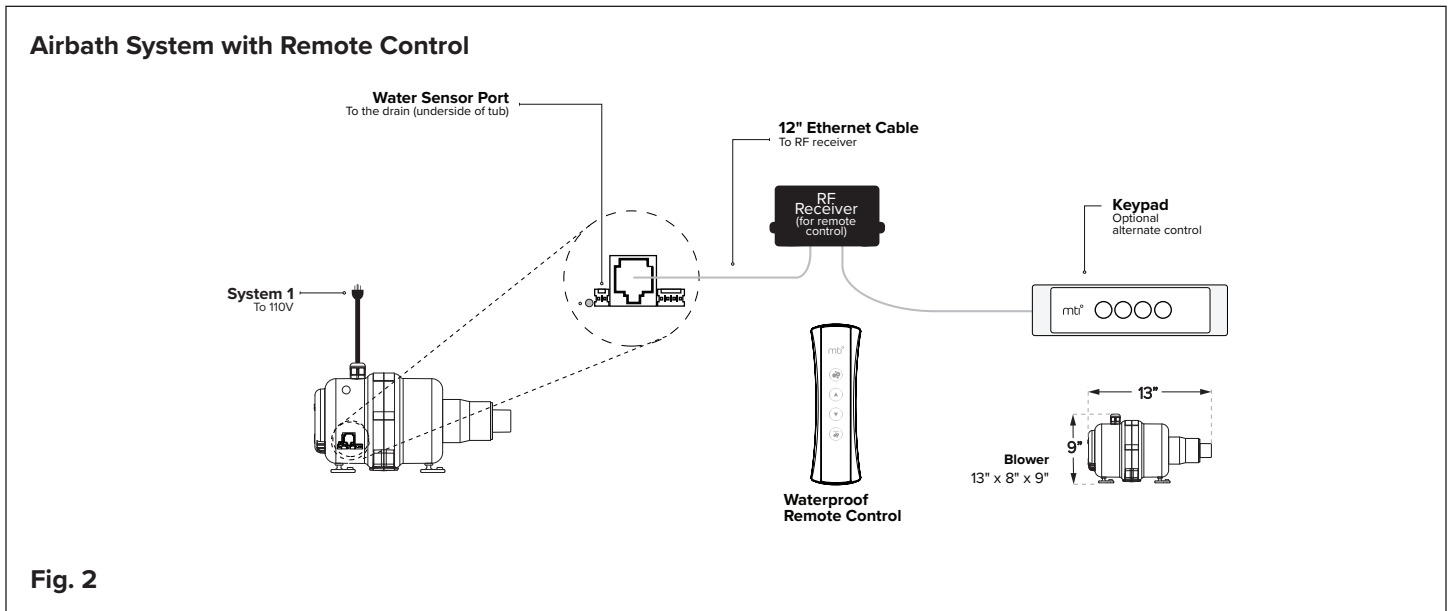

IMPORTANT! Never under any circumstances modify the power cords.

Operation Instructions

Airbath

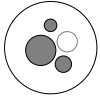
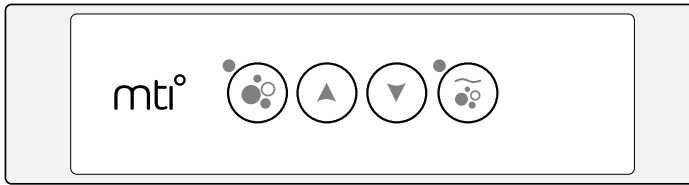

AIRBATH

1st Press: The blower starts. LED indicator light on.
2nd Press: The blower stops. LED indicator light off.
NOTE: Blower automatically stops after 20 minutes.



THERAPY CONTROL

Use arrow buttons to gradually adjust airbath intensity.



AIR MASSAGE MODE

1st Press (Wave): Speed varies gradually from maximum to minimum. LED indicator light is on.
2nd Press (Pulse): Speed alternates quickly between minimum and maximum. LED indicator light will flash.
3rd Press (Max): Returns to maximum speed. LED indicator light off.

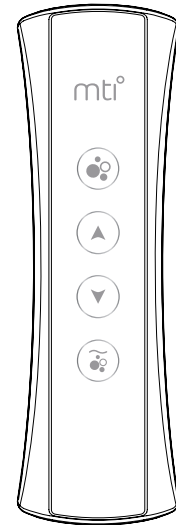

Airbath Remote Control



Automatic Purge / Drying Cycle

MTI airbaths are equipped with an automatic drying cycle designed to purge residual water from air jets installed on the floor of the bath. Drying cycle is programmed to come on 7 minutes after the airbath is turned off and any time water is introduced, then drained from the tub. Water sensors on either side of the tub drain prevent activation of the drying cycle, until water is drained from bath. The sensors will activate the purge/drying cycle upon bathing or cleaning the bathtub.

- The purge cycle starts approximately 7 minutes after the bath is drained and runs for 1 minute.
- To delay the automatic purge for another 7 minutes, once it begins, press . Press again to completely cancel the automatic purge. MTI does not recommend canceling the purge regularly, as the drying cycle is designed to help maintain optimal performance of the airbath.

Alternate 24-hour purge cycle programming overrides default settings, allowing the purge cycle to run once every 24 hours at the time the cycle is first programmed.

To program 24-hour purge cycle:

- Hold  on the keypad for 5 seconds. The indicator light next to the airbath button  flashes once when programmed successfully.
- Press and hold  again for 5 seconds to restore the default setting. The indicator light flashes twice when default setting is restored.

Water sensors will delay daily purge, if there is water in the tub at the time purge cycle is programmed to start. 7 minutes after water has drained, the drying cycle starts.

Manual Stop

Press airbath button  during the 1-minute drying cycle, to stop the cycle. Purge/Drying cycle will restart 24 hours later at the programmed time.

In the event of a power disruption or brown out, the purge/drying cycle will return to default setting. Manually reprogram as needed.



Care and Cleaning Instructions

About the Mineral Composite Shell

Mineral composite has a stain-resistant, non-porous surface. With normal use, this surface will retain its appearance with a minimal amount of care.

When Cleaning

- Remove dust and dry dirt with a soft, damp cloth.
- Apply common household, non-abrasive cleaner in accordance with manufacturer's directions and precautions. (i.e., a mild dishwashing detergent such as Ivory Liquid). Do not use unless the product label specifically states that it is safe for acrylic or plastic.
- Rinse well and dry with a soft, clean cloth. Scouring pads will deteriorate the finish.
- Never use any type of "scrubbing bubbles" or aerosol spray cleaners on the mineral composite product.
- Never use bleach, ammonia or organic solvents, such as lacquer, alcohol, acids or alkalis to come into contact with the product surface.
- Never use abrasive cleansers. If any product feels gritty when rubbed between your fingers, do not use on the mineral composite surface or system controls as permanent damage will occur.

WARNING: Check cleaning and bathing product labels. Do not use unless the product label specifically states that it is safe for acrylic or plastic. Some non-abrasive products damage the surface over time.

General Care

- Do not allow the mineral composite surface to come into contact with nail polish, nail polish remover, Wintergreen oil, dry cleaning solution, lacquer thinners, gasoline, pine oil, etc.
- Avoid using razor blades or other sharp objects that might scratch the surface.
- MTI strongly recommends a professional surface repair person for deep scratches, chips or gouges.
- Damage occurring to the unit during installation is the responsibility of the installer, and after installation, the responsibility of the user.



Troubleshooting

Q: The blower will not turn on. What should I check first?

A: Check the electrical connections. Test the outlet for power. Check to make sure the breaker is not tripped. Replace GFCI outlet or breaker if necessary.

Q: There is a rust colored, greasy ring in my bath tub. What causes this?

A: The condition results from sediment in the water heater of the home. Drain and flush the heater according to the manufacturer's instructions, and then clean the interior of the tub with a mild, grease cutting dish soap.

Q: The air jets on my tub are not blowing air bubbles. What could be the problem?

A: Check that the keypad is connected to the blower, and the blower is plugged into a working receptacle. Check that the gray air hose from the air blower to the manifold is properly secured.

Q: The airbath comes on when not in use.

A: MTI Cosmopolitan Collection airbath is equipped with an automatic purge / drying cycle. See pg. 11 for details.

Q: I understand the purge cycle, however my tub is now purging in the middle of the night. How can I stop this from happening?

A: Small, barely detectable power fluctuations can disrupt the purge cycle. Turn the breaker off (or unplug the blower), wait for ten seconds, then plug back in. The blower should now follow the normal purge cycle.

Q: The air bubbles seem cool. How do I check that the blower is warming the air?

A: To verify, turn the air system on high for 4-5 minutes (you do not need to have water in the tub). Carefully feel the gray air hose where it exits the blower. It should be warm to the touch. If it is cold, please contact MTI for service.

The heated blower is designed to preheat the incoming air and does not warm the bath water. If your tub is installed against an outside wall(s), it is recommended to adequately insulate the wall(s) to minimize heat loss. DO NOT insulate the blower itself; the blower needs sufficient air space surrounding it for proper circulation and operation.

Q: Can I relocate the blower?

A: The air blower can be located up to eight feet from the bath. See Airbath Installation in this manual.

Q: Is it safe to use bath salts or bath oils in my airbath?

A: Water soluble bath salts are fine to use, however, MTI does not recommend the use of heavy bath oils. Products containing natural or chemical dyes may discolor the air jets and/or tub surface. Check the label to ensure products are safe for acrylic or plastics, and always use according to the product recommendations. See the cleaning section of this manual for proper after care and cleaning instructions.

Q: My bath's hydrotherapy system has been working great for years, and now has stopped working. What should I check first?

A: Check breaker box first, then test the outlet. If problem persists, contact MTI Baths with product serial number for assistance.

Q: How do I find the serial or registration number on my bath?

A: Look for the MTI decal on the airbath blower.

Q: The remote control for my air bath no longer functions. What can I do?

A: Barely detectable power fluctuations may occasionally disrupt the remote control. Read all 3 three steps below before beginning synchronization.

1. Turn off the breaker or unplug the blower for 30 seconds.
2. Within 15 seconds of restoring power, simultaneously press the "plus" and "minus" buttons, hold down for 4 seconds, and release. The remote is now ready for use.
3. If the synchronization is not successful, repeat the steps.

If the remote is still inoperable, contact MTI's service department. Please have your serial or registration number available.



MTI Baths, LLC

Residential Limited Lifetime Product Warranty¹

MTI Baths is proud to offer the Residential Limited Lifetime Product Warranty set forth below for Cosmopolitan Collection bathtubs (the “Products”). This Limited Warranty is in lieu of all other warranties.

Application: This Limited Warranty applies solely to Products purchased from an authorized MTI Baths distributor or retailer after March 1, 2023 and installed in the United States. This warranty is product specific and extends only to the original consumer/purchaser of the MTI Baths Product. Original purchase and installation must be within the boundaries of the continental USA². The warranty terminates after transfer of ownership or if the product is installed or relocated outside the boundaries of the continental USA by the original consumer/purchaser prior to the expiration of the warranty period. Warranty coverage begins from date of purchase. Proof of purchase must be provided to MTI Baths upon request. Display floor models and overstock sale units are excluded from this Limited Warranty. Drain kits and accessories that are not manufactured by MTI are excluded from this product warranty.³ Accessories manufactured by MTI Baths carry a one year warranty for parts only.

Lifetime Warranty: MTI Baths warrants that its Products are free of defects in material and workmanship for the lifetime of the product to the original purchaser so long as (1) the Product is installed, maintained and used according to MTI Baths' recommended installation and maintenance procedures and usage instructions, and (2) use of the Product is limited to personal, family or single household purposes. Product installation location must be an indoor, climate-controlled, residential environment.

Shell: MTI Baths (MTI) warrants the shell of the mineral composite tub against defects in material and workmanship for the lifetime of the product to the original purchaser. Slight variations in the surface are indigenous to the natural stone appearance and do not compromise the structural integrity of the product, therefore are not considered defects or flaws. Blemishes, air holes or casting marks on the underside of the bath are not considered defects and do not affect the performance or quality of the product.

Air Bath: The non pro-rated warranty covers the blower against defects in material or workmanship. All other hydrotherapy components included in MTI packages are subject to the MTI Two-Year parts warranty.

Two-Year (Parts Only) Warranty: MTI warrants all Cosmopolitan Collection hydrotherapy components not specified above for two years (parts only) against defects in material or workmanship.

Replacement parts shall assume the remaining warranty period of the parts replaced, and are subject to availability and may differ from those originally supplied. Changes in materials, parts or specifications are not valid reasons for product refusal or replacement under warranty.

Exclusions: This Limited Warranty does not apply to or cover defects, damage or other failures that are the result of normal wear and tear of Products, unauthorized or unreasonable use or improper handling; caused by freight carriers, installers, users or other persons; or accidents or acts of God (e.g. earthquakes, floods, storms). MTI is not responsible for the cost of removing or reinstalling the Product or costs associated with any adjacent materials.

MTI Baths is not responsible for any damage caused by failure to follow Product instructions; neglect by the user during use of the Product; incorrect operation; lack of proper routine maintenance; the use of improper cleaners, abrasives, food, beverages (e.g., red wine), bathing products with harmful dyes or other contents (e.g., glitter), medicinal products (e.g., mecurochrome), make-up or hair dye; cigarette burns or burns from hot appliances; or misuse of any kind. MTI does not warrant leaks associated with improper waste and overflow installation or connections supplied by the installer. This warranty does not cover noises that result from poorly located or improperly installed or maintained plumbing vents. Improper installation of, or any alteration, customization or modification to the Product voids this Limited Warranty in its entirety. MTI Baths is not responsible for any damages caused by filling or overfilling a bathtub or by leaving a full bathtub unattended⁴.

The Product must be water tested for proper drainage, system operation, and leak detection prior to final installation and installed per the installation instructions provided. Failure to do so will void this warranty.

MTI BATHS IS NOT LIABLE FOR INCIDENTAL OR CONSEQUENTIAL DAMAGE, LOSS OF TIME, INCONVENIENCE, INCIDENTAL EXPENSES, LABOR OR MATERIAL CHARGES OR ANY OTHER COSTS RELATED TO THE APPLICATION OF THIS WARRANTY.

¹ Commercial customers please refer to our Commercial Limited Lifetime Warranty.

² Exceptions for Alaskan and Canadian Customers: MTI Baths extends the complete Limited Lifetime Residential Warranty to any mineral composite tub installed within a 75-mile radius of an Authorized MTI Distributor. Any installation site outside the 75-mile radius will be covered for two years, parts only. Exceptions for Hawaiian Customers: MTI Baths extends the complete Limited Lifetime Residential Warranty to Hawaiian customers on the islands of Maui, Kauai and Oahu only. All other locations will be covered for two years, parts only.

³ Many drain kits and accessories carry a factory warranty direct from the manufacturer. Terms vary among manufacturers. Special order finishes for drain kits are excluded from this product warranty.

⁴ Never leave a full bath or filling bath unattended.

Continued on next page...



MTI Baths

Residential Limited Lifetime Product Warranty*

Warranty Claim Process: All claims under the Limited Warranty must be submitted in writing to MTI Baths within 10 days following discovery of the basis of the claim. All such claims must be submitted to service@mtibaths.com to obtain authorized service. Each claim must set forth the date of discovery, a description of the defect, the name and address of the installer of the Product, the date and address of installation, and the type or style of the Product.

The product warranty must be registered within one hundred twenty days from purchase. The product warranty must be registered before service for any malfunction or defect can be authorized. Registration can be completed online at mtibaths.com/contact-us/warranty-registration/ or mailed to MTI Baths at 670 N. Price Rd. Sugar Hill, Georgia 30518. Any claim submitted via an alternative method or without the required information shall be null and void.

Damage that occurred in transit is the responsibility of the carrier. The consignee must open and inspect the Product for damage when it is delivered. If the Product is damaged, this must be reported immediately to both the seller and the carrier in writing and an inspection must be requested. In the event that the carrier fails to respond, report such response to both the seller and the carrier. Any freight claims must be filed within ten business days. The installer(s) or person(s) (Consignee) acting on behalf of the Product owner is responsible for ensuring that the Product is free of defect or damage prior to installation. The Product Owner or Consignee must open and inspect the Product for damage when it is delivered. Product damage must be reported prior to installation.

Warranty Performance/Limited Remedy: As the sole and exclusive remedy, and MTI Baths' sole liability, for breach of the Limited Warranty, MTI Baths, will, at its election, repair, replace or make appropriate adjustments to the Product. MTI reserves the right to inspect the malfunction or defect on site and repair or replace the Product at its discretion. In all cases a reasonable time must be allowed for commencement and completion of warranty repairs, replacements, or adjustments. Repairs will be made by an authorized MTI Baths repairer. Replacement parts and/or repair services authorized under the terms of this warranty will result in the issuance of a service order number. No payment for services rendered will be made by MTI Baths without an MTI authorized service order.

MTI Baths will not authorize any service unless clear access is available. MTI is not responsible for the provision of proper access. A minimum size of 16"x14" access to each component on the Product must be provided. Access from a crawlspace or incomplete access to all equipment may result in warranty claims being denied.

Labor Not Included: MTI Baths is not responsible for labor charges or other charges related to the removal or installation or other costs involved in repairing or replacing the Product or the expense of shipment to or from the factory, except where provided by applicable law.

To obtain further information about this Limited Warranty and MTI Baths' warranty obligations please contact the MTI Service Department at 800.783.8827 or email service@mtibaths.com. Must have registration number available.

No other company or person has any authority to make any warranties or representations concerning MTI Baths or any Products. Accordingly, MTI Baths is not responsible for any such warranties or representations.

THIS LIMITED WARRANTY IS THE SOLE WARRANTY FOR THE MTI BATHS PRODUCT AND IS IN LIEU OF ALL OTHER WARRANTIES, EXPRESSED OR IMPLIED, RELATING TO SUCH PRODUCT INCLUDING WITHOUT LIMITATION ANY IMPLIED WARRANTIES OF CONDITION, MERCHANTABILITY, DESIGN, OPERATION OR FITNESS FOR ANY PARTICULAR USE OR PURPOSE, OR QUALITY OF THE MATERIALS OR WORKMANSHIP.

Disclaimers: MTI Baths is not liable for special, incidental or consequential damages/losses from any cause, including water damage to carpeting, floors, or ceilings.

SOME STATES DO NOT ALLOW THE EXCLUSION OR LIMITATION, IN WHOLE OR IN PART, OF WARRANTIES OR THE EXCLUSION OF SPECIAL, CONSEQUENTIAL OR INCIDENTAL DAMAGES. THEREFORE, THE ABOVE LIMITATIONS OR EXCLUSIONS MAY NOT BE APPLICABLE TO YOU.



**Customer
Service**
Monday-Friday
8am-6pm EST

To verify coverage or request service, please contact the MTI Service Department and have serial or registration number available.

800-783-8827
service@mtibaths.com



MTI Baths, LLC

Commercial Limited Two-Year Product Warranty¹

MTI Baths is proud to offer the Commercial Two-Year Product Warranty set forth below for Cosmopolitan Collection bathtubs (the "Products"). This Limited Warranty is in lieu of all other warranties.

Application: This Limited Warranty applies solely to Products purchased from an authorized MTI Baths distributor or retailer after March 1, 2023 and installed in the United States. This warranty is product specific and extends only to the original purchaser of the MTI Baths Product. Original purchase and installation must be within the boundaries of the continental USA². The warranty terminates after transfer of ownership or if the product is installed or relocated outside the boundaries of the continental USA by the original purchaser prior to the expiration of the warranty period. Warranty coverage begins from date of purchase. Proof of purchase must be provided to MTI Baths upon request. Display floor models and overstock sale units are excluded from this Limited Warranty. Drain kits and accessories that are not manufactured by MTI are excluded from this product warranty.³ Accessories manufactured by MTI Baths carry a one year warranty for parts only.

Two-year Warranty: MTI Baths warrants that its Products are free of defects in material and workmanship for two years from date of purchase to original purchaser so long as (1) the Product is installed, maintained and used according to MTI Baths' recommended installation and maintenance procedures and usage instructions, and (2) use of the Product is limited to commercial, rental, or multi-family application. Product installation location must be an indoor, climate-controlled, commercial environment.

Shell: MTI Baths (MTI) warrants the shell of the mineral composite tub against defects in material and workmanship for two years from date of purchase to the original purchaser. Slight variations in the surface are indigenous to the natural stone appearance and do not compromise the structural integrity of the product, therefore are not considered defects or flaws. Blemishes, air holes or casting marks on the underside of the bath are not considered defects and do not affect the performance or quality of the product.

Air Bath: The non pro-rated warranty covers the blower against defects in material or workmanship. All other hydrotherapy components included in MTI packages are subject to the MTI Two-Year parts warranty.

One-Year (Parts Only) Warranty: MTI warrants all Cosmopolitan Collection hydrotherapy components not specified above for one year (parts only) against defects in material or workmanship.

Replacement parts shall assume the remaining warranty period of the parts replaced, and are subject to availability and may differ from those originally supplied. Changes in materials, parts or specifications are not valid reasons for product refusal or replacement under warranty.

Exclusions: This Limited Warranty does not apply to or cover defects, damage or other failures that are the result of normal wear and tear of Products, unauthorized or unreasonable use or improper handling; caused by freight carriers, installers, users or other persons; or accidents or acts of God (e.g. earthquakes, floods, storms). MTI is not responsible for the cost of removing or reinstalling the Product or costs associated with any adjacent materials.

MTI Baths is not responsible for any damage caused by failure to follow Product instructions; neglect by the user during use of the Product; incorrect operation; lack of proper routine maintenance; the use of improper cleaners, abrasives, food, beverages (e.g., red wine), bathing products with harmful dyes or other contents (e.g., glitter), medicinal products (e.g., mecurochrome), make-up or hair dye; cigarette burns or burns from hot appliances; or misuse of any kind. MTI does not warrant leaks associated with improper waste and overflow installation or connections supplied by the installer. This warranty does not cover noises that result from poorly located or improperly installed or maintained plumbing vents. Improper installation of, or any alteration, customization or modification to the Product voids this Limited Warranty in its entirety. MTI Baths is not responsible for any damages caused by filling or overfilling a bathtub or by leaving a full bathtub unattended⁴.

The Product must be water tested for proper drainage, system operation, and leak detection prior to final installation and installed per the installation instructions provided. Failure to do so will void this warranty.

MTI BATHS IS NOT LIABLE FOR INCIDENTAL OR CONSEQUENTIAL DAMAGE, LOSS OF TIME, INCONVENIENCE, INCIDENTAL EXPENSES, LABOR OR MATERIAL CHARGES OR ANY OTHER COSTS RELATED TO THE APPLICATION OF THIS WARRANTY.

¹ Residential customers please refer to our Residential Limited Lifetime Warranty.

² Exceptions for Alaskan and Canadian Customers: MTI Baths extends the complete Limited Two-Year Product Warranty to any mineral composite bath installed within a 75-mile radius of an Authorized MTI Distributor. Any installation site outside the 75-mile radius will be covered for one year, parts only. Exceptions for Hawaiian Customers: MTI Baths extends the complete Two-Year Limited Product Warranty to Hawaiian customers on the islands of Maui, Kauai and Oahu only. All other locations will be covered for one year, parts only.

³ Many drain kits and accessories carry a factory warranty direct from the manufacturer. Terms vary among manufacturers. Special order finishes for drain kits are excluded from this product warranty.

⁴ Never leave a full bath or filling bath unattended.

Continued on next page...



MTI Baths

Commercial Limited Two-Year Product Warranty¹

Warranty Claim Process: All claims under the Limited Warranty must be submitted in writing to MTI Baths within 10 days following discovery of the basis of the claim. All such claims must be submitted to service@mtibaths.com to obtain authorized service. Each claim must set forth the date of discovery, a description of the defect, the name and address of the installer of the Product, the date and address of installation, and the type or style of the Product.

The product warranty must be registered within one hundred twenty days from purchase. The product warranty must be registered before service for any malfunction or defect can be authorized. Registration can be completed online at mtibaths.com/contact-us/warranty-registration/ or mailed to MTI Baths at 670 N. Price Rd. Sugar Hill, Georgia 30518. Any claim submitted via an alternative method or without the required information shall be null and void.

Damage that occurred in transit is the responsibility of the carrier. The consignee must open and inspect the Product for damage when it is delivered. If the Product is damaged, this must be reported immediately to both the seller and the carrier in writing and an inspection must be requested. In the event that the carrier fails to respond, report such response to both the seller and the carrier. Any freight claims must be filed within ten business days. The installer(s) or person(s) (Consignee) acting on behalf of the Product owner is responsible for ensuring that the Product is free of defect or damage prior to installation. The Product Owner or Consignee must open and inspect the Product for damage when it is delivered. Product damage must be reported prior to installation.

Warranty Performance/Limited Remedy: As the sole and exclusive remedy, and MTI Baths' sole liability, for breach of the Limited Warranty, MTI Baths, will, at its election, repair, replace or make appropriate adjustments to the Product. MTI reserves the right to inspect the malfunction or defect on site and repair or replace the Product at its discretion. In all cases a reasonable time must be allowed for commencement and completion of warranty repairs, replacements, or adjustments. Repairs will be made by an authorized MTI Baths repairer. Replacement parts and/or repair services authorized under the terms of this warranty will result in the issuance of a service order number. No payment for services rendered will be made by MTI Baths without an MTI authorized service order.

MTI Baths will not authorize any service unless clear access is available. MTI is not responsible for the provision of proper access. A minimum size of 16"x14" access to each component on the Product must be provided. Access from a crawlspace or incomplete access to all equipment may result in warranty claims being denied.

Labor Not Included: MTI Baths is not responsible for labor charges or other charges related to the removal or installation or other costs involved in repairing or replacing the Product or the expense of shipment to or from the factory, except where provided by applicable law.

To obtain further information about this Limited Warranty and MTI Baths' warranty obligations please contact the MTI Service Department at 800.783.8827 or email service@mtibaths.com. Must have registration number available.

No other company or person has any authority to make any warranties or representations concerning MTI Baths or any Products. Accordingly, MTI Baths is not responsible for any such warranties or representations.

THIS LIMITED WARRANTY IS THE SOLE WARRANTY FOR THE MTI BATHS PRODUCT AND IS IN LIEU OF ALL OTHER WARRANTIES, EXPRESSED OR IMPLIED, RELATING TO SUCH PRODUCT INCLUDING WITHOUT LIMITATION ANY IMPLIED WARRANTIES OF CONDITION, MERCHANTABILITY, DESIGN, OPERATION OR FITNESS FOR ANY PARTICULAR USE OR PURPOSE, OR QUALITY OF THE MATERIALS OR WORKMANSHIP.

Disclaimers: MTI Baths is not liable for special, incidental or consequential damages/losses from any cause, including water damage to carpeting, floors, or ceilings.

SOME STATES DO NOT ALLOW THE EXCLUSION OR LIMITATION, IN WHOLE OR IN PART, OF WARRANTIES OR THE EXCLUSION OF SPECIAL, CONSEQUENTIAL OR INCIDENTAL DAMAGES. THEREFORE, THE ABOVE LIMITATIONS OR EXCLUSIONS MAY NOT BE APPLICABLE TO YOU.



**Customer
Service**
Monday-Friday
8am-6pm EST

To verify coverage or request service, please contact the MTI Service Department and have serial or registration number available.

800-783-8827
service@mtibaths.com



MTI Baths, LLC
670 North Price Road
Sugar Hill, GA 30518
p: (800) 783-8827
f: (800) 438-8827

mtibaths.com

© Copyright 2023 by MTI Baths, LLC.
Modification Rights Reserved. 0123