

## Liberty

Part # - MTPS-108



### AVAILABLE COLORS

White - Part # MTPS108W \$255  
 Bone, Biscuit - Part # MTPS108B\* \$260  
 Black, Sterling Silver - Part # MTPS108GRP1\* \$305

*\*Must specify color on order*

### OPTIONS

Quick Ship / Priority. *Call for availability.* Part # QUISINKSH \$175  
 Shipping Weight: 10 lbs

NOTES: Due to the particular shape of this sink, MTI recommends having the product on site before attempting any cut-out in counter top material. Measurements are  $\pm 1/2"$  and are subject to change without notice. Data herein supersedes all previous prior to publication date indicated below.

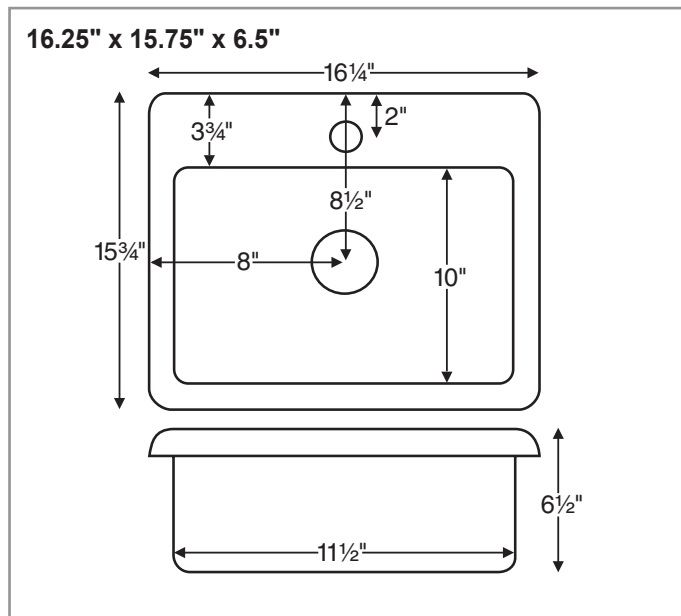

## Sequel

Part # - MTBS-105



### AVAILABLE COLORS

White - Part # MTBS105W \$185  
 Bone, Biscuit - Part # MTBS105B\* \$190  
 Black, Sterling Silver - Part # MTBS105GRP1\* \$230

*\*Must specify color on order*

### OPTIONS

Quick Ship / Priority. *Call for availability.* Part # QUISINKSH \$175  
 Shipping Weight: 7 lbs

NOTES: Measurements are  $\pm 1/2"$  and are subject to change without notice. Data herein supersedes all previous prior to publication date indicated below.

### CONSTRUCTION AND STANDARD FEATURES

- Single-bowl design; 3.5" drain opening pre-drilled.
- Can be undermounted or caulked directly to the countertop without the use of clips or channels.
- No holes can be drilled for Liberty. For Sequel, no holes drilled standard; up to 3 holes drilled by MTI at no additional charge.
- Durable Lucite® cast acrylic shell is extremely scratch- and stain-resistant yet renewable because the color goes all the way through the material.
- Non-porous surface makes cleaning and sanitizing faster and more effective.
- Multi-layered reinforced backing of thick fiberglass / resin / titanium.
- At least 30% thicker and stronger than other makes.
- 2-year limited residential and commercial warranty.