

4VOR60XXD Series Fan
UL Model No. : AC-560F819

MONTE CARLO®

MonteCarloFans.com

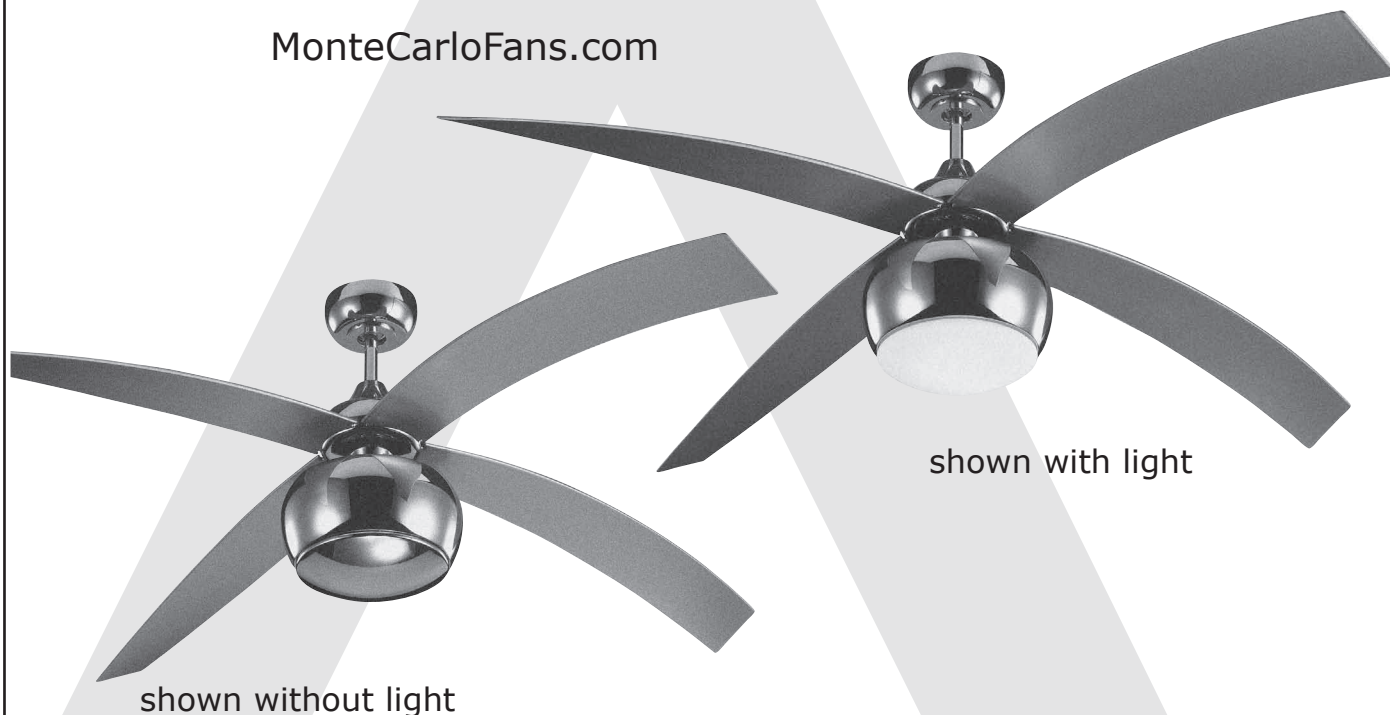

To register your fixture, please visit our website:
MonteCarloFans.com

STOP

NEED HELP?

¿NECESITA AYUDA?

AVEZ-VOUS BESOIN D'AIDE?

ALTO

Please do not return this product to the store.
Por favor no devuelva este producto a la tienda.
Prière de ne pas retourner ce produit au magasin.

If you need installation assistance, replacement parts, or have questions regarding our warranty, please call our customer care center:

Si necesita asistencia en la instalación, piezas de repuesto, o tiene preguntas acerca de nuestra garantía, por favor llame a nuestro centro de servicio al cliente:

Si vous avez besoin d'aide pour l'installation, des pièces de remplacement, ou si vous avez des questions concernant notre garantie, veuillez contacter notre service après-vente:

1-800-519-4092

MonteCarloFans.com

Total fan weight
with light kit

**READ AND SAVE
THESE INSTRUCTIONS**



Helpful Tools

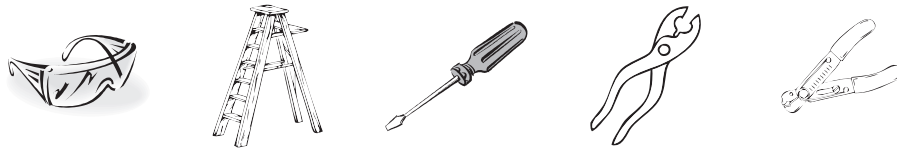

Safety instructions

WARNING: TO REDUCE THE RISK OF FIRE, ELECTRIC SHOCK, OR INJURY TO PERSONS, OBSERVE THE FOLLOWING: READ AND SAVE THESE INSTRUCTIONS

1. Installation work and electrical wiring must be done by qualified person(s) in accordance with applicable codes and standards (ANSI/NFPA 70-1999), including fire-rated construction.
2. Use this unit only in the manner intended by the manufacturer. If you have any questions contact the manufacturer.
3. After making the wire connections, the wires should be spread apart with the grounded conductor and the equipment-grounding conductor on one side of the outlet box and ungrounded conductor on the other side of the outlet box. The splices, after being made, should be turned upward and pushed carefully up into the outlet box.
4. **WARNING:** Before you begin installing the fan, servicing or cleaning unit, Switch power off at Service panel and lock service disconnecting means to prevent power from being switched on accidentally. When the service disconnecting means cannot be locked, securely fasten a prominent warning device, such as a tag, to the service panel.
5. Be cautious! read all instructions and safety information before installing your new fan. Review the accompanying assembly diagrams.
6. When cutting or drilling into wall or ceiling, do not damage electrical wiring and other hidden utilities.
7. Make sure the installation site you choose allows the fan blades to rotate without any obstructions. Allow a minimum clearance of 7 feet from the floor to the trailing edge of the blade.
8. **WARNING:** To reduce the risk of fire, electric shock, or personal injury, mount to outlet box marked "acceptable for fan support" and use mounting screws provided with the outlet box (Mounting must support at least 35 lbs.)
9. **WARNING:** To reduce the risk of personal injury, do not bend blade holders during installation to motor, balancing or during cleaning. Do not insert foreign object between rotating blades.
10. Attach the mounting bracket using only the hardware supplied with the outlet box.
11. **WARNING:** To reduce the risk of fire or electric shock, this fan must be installed with an isolating wall control/switch.
12. **WARNING:** To reduce the risk of fire or electric shock, this fan should only be used with fan speed control part no. UC7067RC manufactured by Rhine Electronic Co., Ltd.
13. **WARNING:** To reduce the risk of fire or electric shock, do not use this fan with any solid state fan speed control device, or variable speed control.
14. If this unit is to be installed over a tub or shower, it must be marked as appropriate for the application.
15. Never place a switch where it can be reached from a tub or shower.
16. The combustion airflow needed for safe operation of fuel-burning equipment may be affected by this unit's operation. Follow the heating equipment manufacturer's guideline safety standards such as those published by the National Fire Protection Association (NFPA), and the American Society for Heating, Refrigeration and Air Conditioning Engineers (ASHRAE) and the local code authorities.
17. **CAUTION:** To Reduce the Risk of Electric Shock, Disconnect the electrical supply circuit to the fan before installing the light kit.
18. All set screws must be checked and tightened where necessary before installation.



1
Before you begin installing the fan, Switch power off at Service panel and lock service disconnecting means to prevent power from being switched on accidentally. When the service disconnecting means cannot be locked, securely fasten a prominent warning device, such as a tag, to the service panel.



2
Before installing this fan make sure the outlet box is properly installed to the house structure. To reduce the risk of fire, electric shock, or personal injury, mount to outlet box or supporting system acceptable for fan support. (Mounting must support at least 35 lbs.)



3
Use metal outlet box suitable for fan support and use only the screws provided with the outlet box (must support 35 lbs). Before attaching fan to outlet box, ensure the outlet box is securely fastened by at least two points to a structural ceiling member (a loose box will cause the fan to wobble). Remove the two outlet box screws provided with the box, aligning the holes of the mounting bracket with the holes of the outlet box. Re-install the 2 outlet box screws securely.

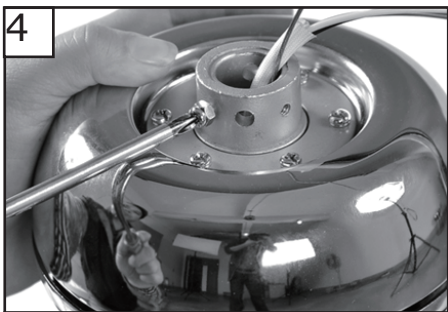

4
Remove 2 set screws from yoke. Save screws for later use.



5
Remove keeper pin and cross pin from yoke, and save for later use.

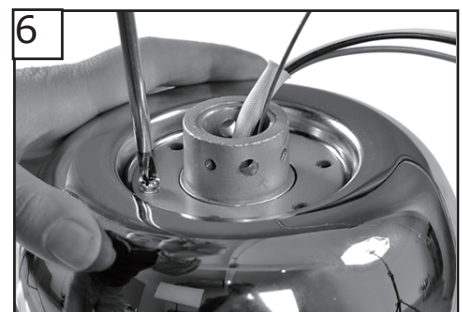

6
Remove 6 preassembled screws from top of motor assembly. Save screws for later use.



Remove the reinforced plate and top housing from motor assembly. Keep the parts for later use.

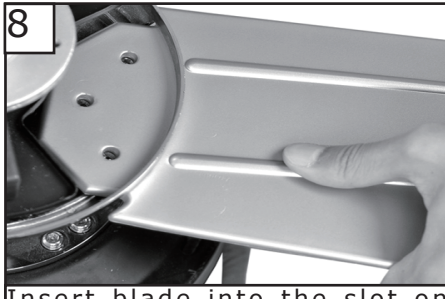

Insert blade into the slot on flywheel.
Note: The ABS blades are curved by design. Do not attempt to bend the blades. Distorting the blades could cause the fan to wobble.

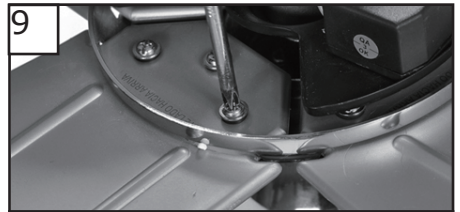

Install blade with screws and fiber washers provided, aligning each of the holes as shown and tighten all screws securely. Repeat this process for remaining blades.
Note: Make sure the side with a label "This side up" is installed upward.

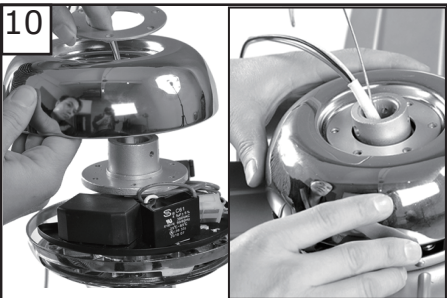

Replace the top housing and reinforced plate.

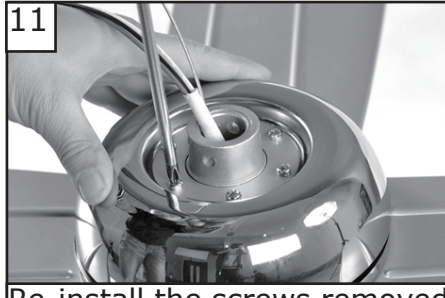

Re-install the screws removed in step 6.



Place canopy over downrod



Place canopy bottom cap over downrod and then place yoke cover over downrod as shown.



Thread lead wires and safety cable through downrod.



Insert downrod into the yoke on top of fan body. Align the hole in the downrod with the hole in the yoke. Insert cross pin through yoke and downrod until point appears on the other side.
Install Keeper pin.



Re-install the 2 set screws removed in step 4 and tighten the set screws evenly once the down rod is in place.



Loosen one and remove one preassembled screws from mounting bracket. Save screw for later use.



Hang assembled fan from the mounting bracket installed to ceiling in previous step. Make sure the fan is hanging straight. Rotate fan until the tab on the Mounting bracket engages the slot on the Downrod Ball. **This must be done to prevent the fan body from rotating when the blades are in motion.**

19 Safety cable installation

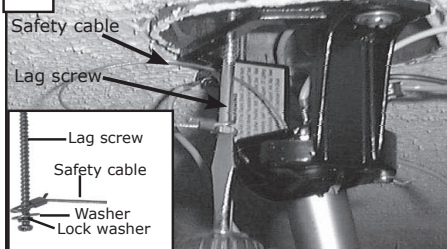

For Canadian installation and for USA fan and light kit combinations over 35 lbs, in both flush and downrod mode the safety cable must be installed into the house structure beams using the 3" lag screws, washers, and lock washers, provided. Make sure that when the safety cable is fully extended the leadwires are longer than the cable and no stress is placed on the leadwires.

20 Remote transmitter dip switch

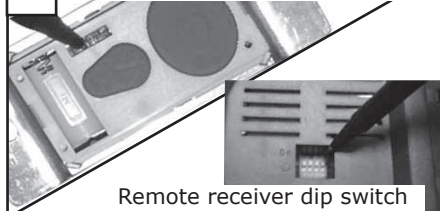

Set dip switches on the Remote Transmitter and Remote Receiver to the same settings. This must be done so the units will communicate properly. If you have other fans you can set to control from one transmitter by setting both receivers the same as the transmitter. If you have more than one fan with remote. You can set the dip switches to different positions to have separate control.

21



Install remote receiver into the mounting bracket.

22

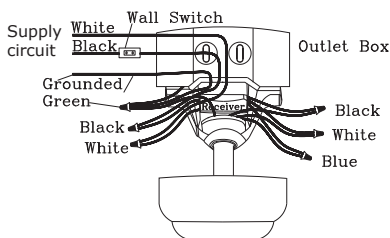

Make wiring connections as indicated above. White from fan to white from remote marked N. Blue from fan to blue from remote marked light. Black from fan to Black from remote marked L. White from house to white from remote marked AC N. Black from house to Black from remote marked AC L. Connect all green ground wires to Grounded wire from House.

23



Make wire connections to power source using wire nuts provided. Make sure that no filaments are outside of the wirenut. After making the wire connections, the wires should be spread apart with the grounded conductor and the equipment-grounding conductor on one side of the outlet box and ungrounded conductor on the other side of the outlet box. The splices after being made should be turned upward and pushed carefully up into the outlet box.

24



Lift canopy up, aligning its keyhole slot with the preassembled screw on mounting bracket and twist clockwise to lock in place. Install the screw removed in step 17. Tighten all screws securely.

25



Attached canopy bottom cap onto canopy by aligning its notches with the screws on mounting bracket and twist clockwise till tight.

26



Loosen 2 and remove 1 preassembled screws from the plate on motor. Save screw for later use.

27



Attach light pan onto the plate on motor assembly, aligning its keyhole slots with the screws on plate and twist clockwise till lock. Re-install the screw removed in step 26. Tighten all screws securely.

28



Loosen two screws and remove one screw from light pan. Save screw for later use.

29



Connect white wire from fan to white wire from light fixture, then connect black wire from fan to black wire from light fixture.

30

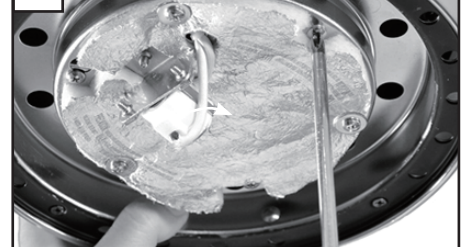

Align keyhole slots of the light fixture with the screws on light pan and twist clockwise till tight. Install the screw which removed in step 28. Tighten all screws securely.

For fan without light, go to step 31.

For fan with light, go to step 32.

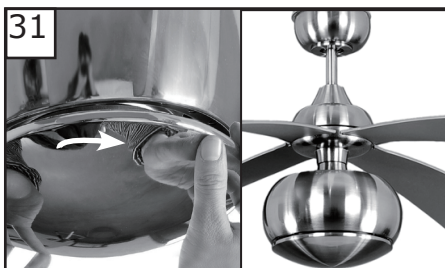

Attach blanking plate by locating dimples in light fixture with grooves in the blanking plate and twist clockwise to lock in place. **WARNING:** Make sure light bulb is not installed when using this cover.

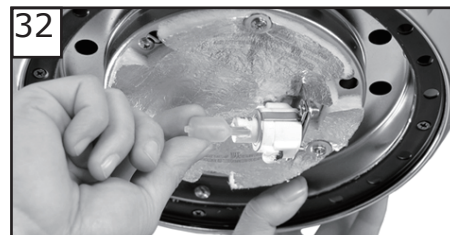

Install 75-watt JD E11 base bulbs. Bulbs included. **WARNING:** Over lamping the fan will result in the fan lights shutting down until the proper wattage of bulbs are installed. Reset the lights by turning off, replace bulbs with the correct wattage bulbs, turn the power on. **Note:** Do not replace bulb until it cools down.



Attach glass by locating dimples in light fixture with grooves in the glass and twist clockwise until tight.

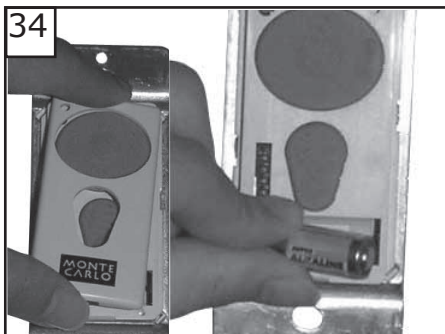

Remove battery cover. Install 12V battery into wall remote. Duracell MN21 / Eveready A23 / GP 23A all 12V. Attach cover of remote by placing over buttons and snap the battery cover in place.



Place face plate over battery compartment and buttons. Place remote over 2 pins on front cover. Attach cover of remote by placing over 4 pins and snapping into place.

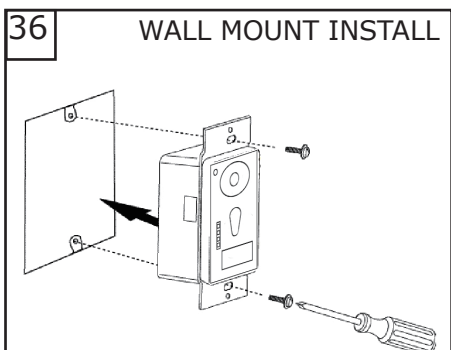

Install wall control unit to outlet box using machine screws provided.

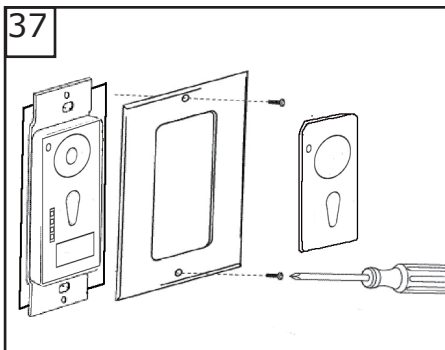

Attach front cover to wall control with screws provided. Snap battery cover in place.

Remote Control Transmitter Features:

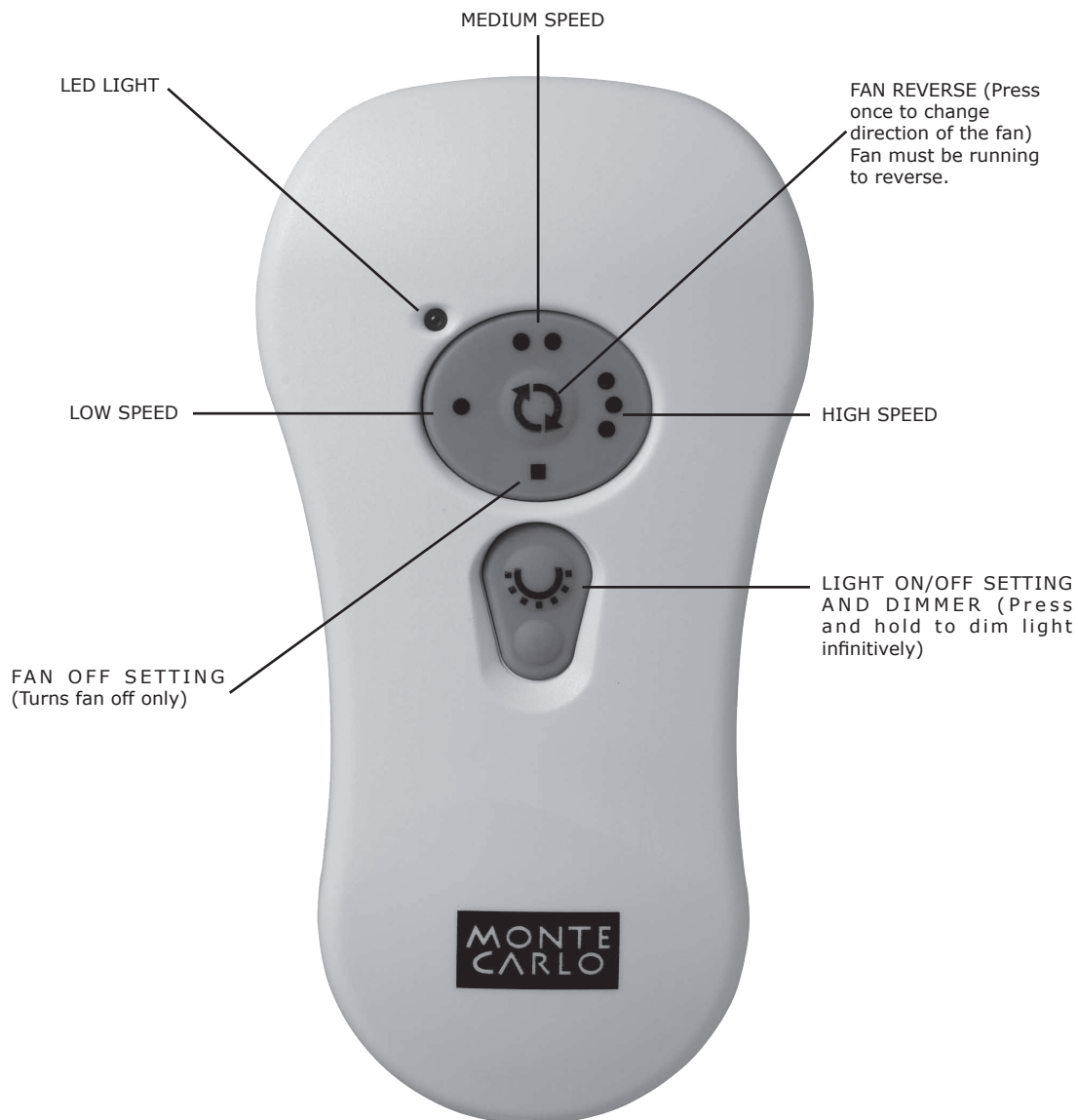

FAN SPEED Depress "1 dot" for low speed, "2 dots" for medium or "3 dots" for high. To turn fan off press square".

LIGHT DIMMER To turn light on, press light dimmer once quickly. To turn off press once quickly while light is on. To dim light hold down button "light dimmer". The light will cycle from bright to dim to bright until button is released. Light will maintain last setting if turned off.

FORWARD/REVERSE Depress rev button allow a few seconds for remote to change rotation direction with fan running.

Trouble Shooting

If you have difficulty operating your new ceiling fan, it may be the result of incorrect assembly, installation, or wiring. In some cases, these installation errors may be mistaken for defects. If you experience any faults, please check this Trouble Shooting Chart. If a problem cannot be remedied, or you are experiencing difficulty in installation, please call our Customer Service Center at the number printed on your parts list insert sheet.

Warning: Before servicing or cleaning unit, Switch power off at Service panel and lock service disconnecting means to prevent power from being switched on accidentally. When the service disconnecting means cannot be locked, securely fasten a prominent warning device, such as a tag, to the service panel.

Trouble	Suggested Remedy
1. If fan does not start:	<ol style="list-style-type: none">1.Check main and branch circuit fuses or circuit breakers.2.Check line wire connections to fan and switch wire connections in switch housing. CAUTION: Make sure main power is turned off.3.If this fan uses manual forward/reverse switch, make sure the switch is pushed firmly either way. Fan will not operate when switch is in the middle.4.If this fan uses remote controller, make sure dip switches are setting properly and make sure battery is effective.
2. If fan sounds noisy:	<ol style="list-style-type: none">1.Check to make sure all screws in motor housing are snug (not over tightened).2.Check to make sure the screws which attach the fan blade holder to the motor are tight.3.Check to make sure wire nut connectors in switch housing are not rattling against each other or against the interior wall of the switch housing. CAUTION: Make sure main power is turned off before entering switch housing.4.Check to be sure light bulb is tight in socket and not touching the glass shade.5.Some fan motors are sensitive to signals from Solid State variable speed controls.6.Allow "break-in" period of 24 hours. Most noises associated with a new fan will disappear after this period.
3. If fan wobbles:	<ol style="list-style-type: none">1.If this is a downrod mount fan, make sure that the ridge of the canopy engages the notch in the downrod ball.2.Make sure that canopy, mounting bracket or mounting plate are tightened securely to ceiling junction box and junction box is mounted firmly to ceiling joist.3.Check that all blades are screwed firmly into blade holders.4.Check that all blade holders are tightened securely to motor.5.Most fan wobble problems are caused when blade levels are unequal. Check this level by selecting a point on the ceiling above the tip of one of the blades. Measure this distance from blade tip to ceiling. Keeping measure within 1/8", rotate the fan until the next blade is positioned for measurement. Repeat for each blade. If all blade levels are not equal, you can adjust blade levels by the following procedure. To adjust a blade tip down, insert a washer (not supplied) between the blade and blade holder at the screw closest to the motor. To adjust a blade tip up, insert washer (not supplied) between the blade and blade holder at the two screws farthest from the motor. Reverse the position of the washer if blades mount from top of blade.6.If blade wobble is still noticeable, interchanging two adjacent (side by side) blades can redistribute the weight and possibly result in smoother operation.
4. If light does not work:	<ol style="list-style-type: none">1.Check blue wire from fan to make sure it is connected to hot wire from house.2.Check for loose or disconnected wires in fan switch housing.3.Check for loose or disconnected wires in light kit.4.Check for faulty light bulb and make sure bulb is tight in socket.5.Remove light kit and check the plug connections if they are present.6.If this fan uses remote controller, make sure dip switches are setting properly and make sure battery is effective. <p>CAUTION: Make sure main power is turned off before entering switch housing and/or canopy.</p> <p>WARNING: Over lamping the fan will result in the fan lights shutting down until the proper wattage of bulbs are installed. Reset the lights by turning off, replace bulbs with the correct wattage bulbs, Turn power on.</p>

Jan.2011