

Model: Wimbledon - 24"

Installation Instructions

Notes: We recommend that you rough-in the drain and water lines after receiving the unit.
 The vanity should be installed by a professional plumber.
 Drainer pipe and trap are not included.

Part List	A(back splash)	B(cabinet)	C(pop-up)	D(handle)	E(handle)	F(screw)	G(adjust screw)
Photo							
Qty	1	1	1	1	2	6	4

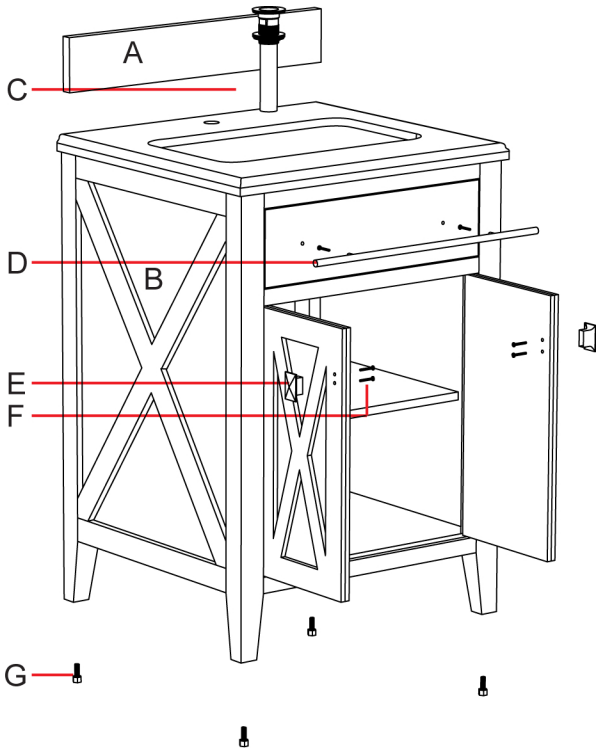

Step 2

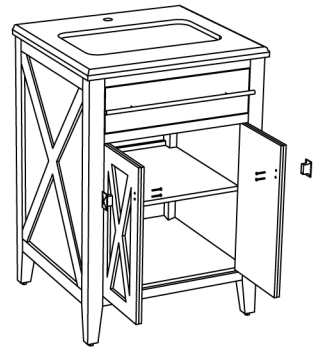

Step 3

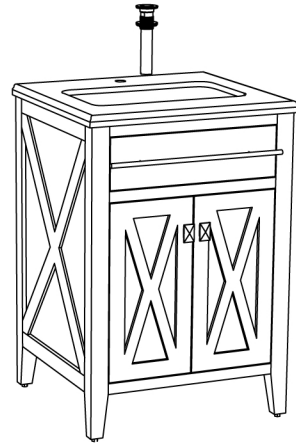

Step 1

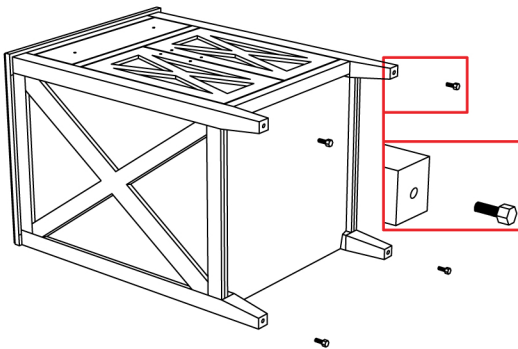

Step 4

