

MISENO

USER GUIDE

SINGLE DOOR MEDICINE CABINET WITH LED LIGHTING



MODEL:
MM2426SLED

IMPORTANT SAFETY INFORMATION

Please read through this installation instruction so you will know how to install and operate your model properly. Keep this document in a safe place for future reference after use.

WARNING

This product must be installed in accordance with the installation instruction by qualified technician. Failure to follow instruction could result in death or serious bodily injury.

CAUTION

This product must be serviced by qualified personnel. ALWAYS unplug the power cord or turn off the circuit breaker before service.

PACKAGE CONTENTS

Cabinet

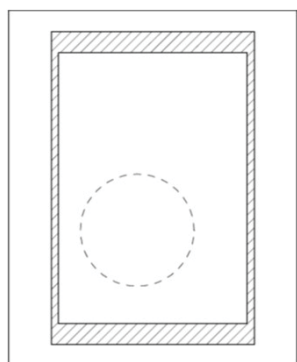

(x1)

Glass Shelf



(MM2426SLED x2)

Shelf Support Pin



(MM2426SLED x8)

Wood Screw



(MM2426SLED x4)

INSTALLATION

1

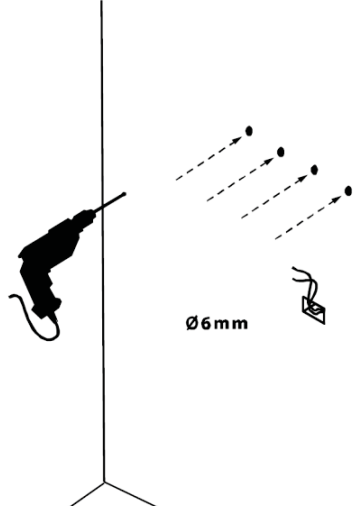

Ø6mm

For drywall installation, mark the hole locations and drill \varnothing 6mm holes for the drywall anchors.

2

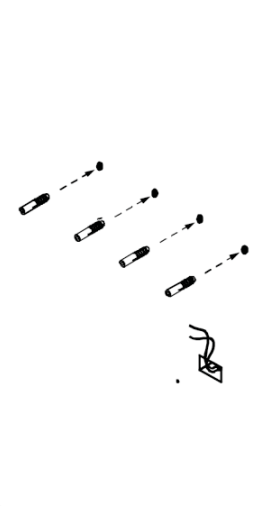

Insert provided drywall anchors.

3

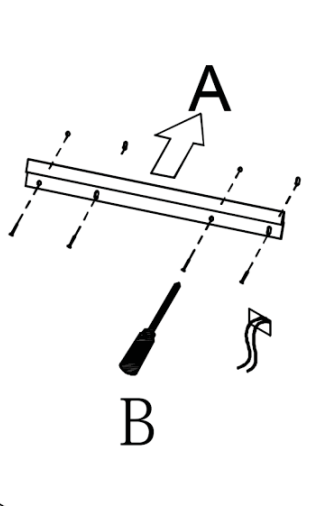

Install the mounting bracket.

4

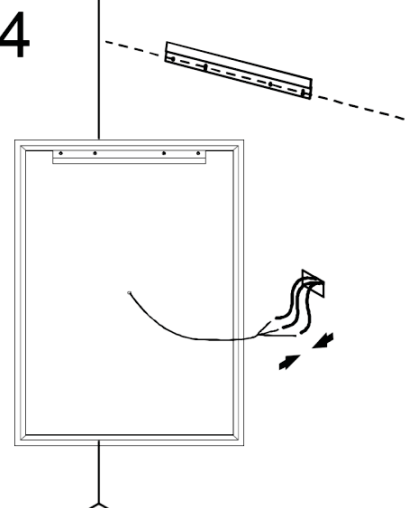

Connect to 110V power supply.

5

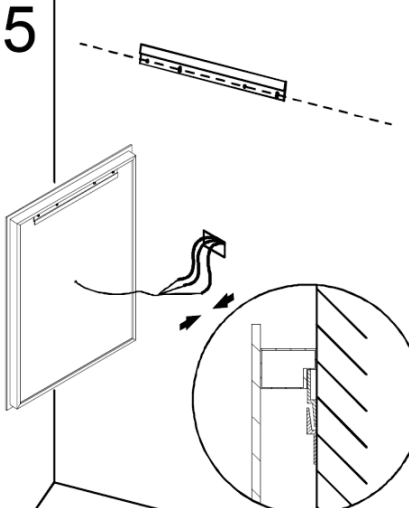

Hang the mirror to the wall and make sure the bracket in the back of the mirror lineup with the mounting bracket properly.

6

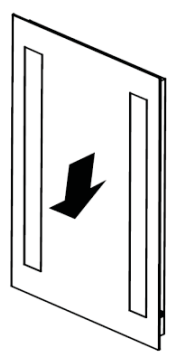

Press the mirror down slightly and make sure the brackets fit properly.



- Using the wall studs to hang the mirror is highly recommended.

INSTALLATION DIMENSIONS

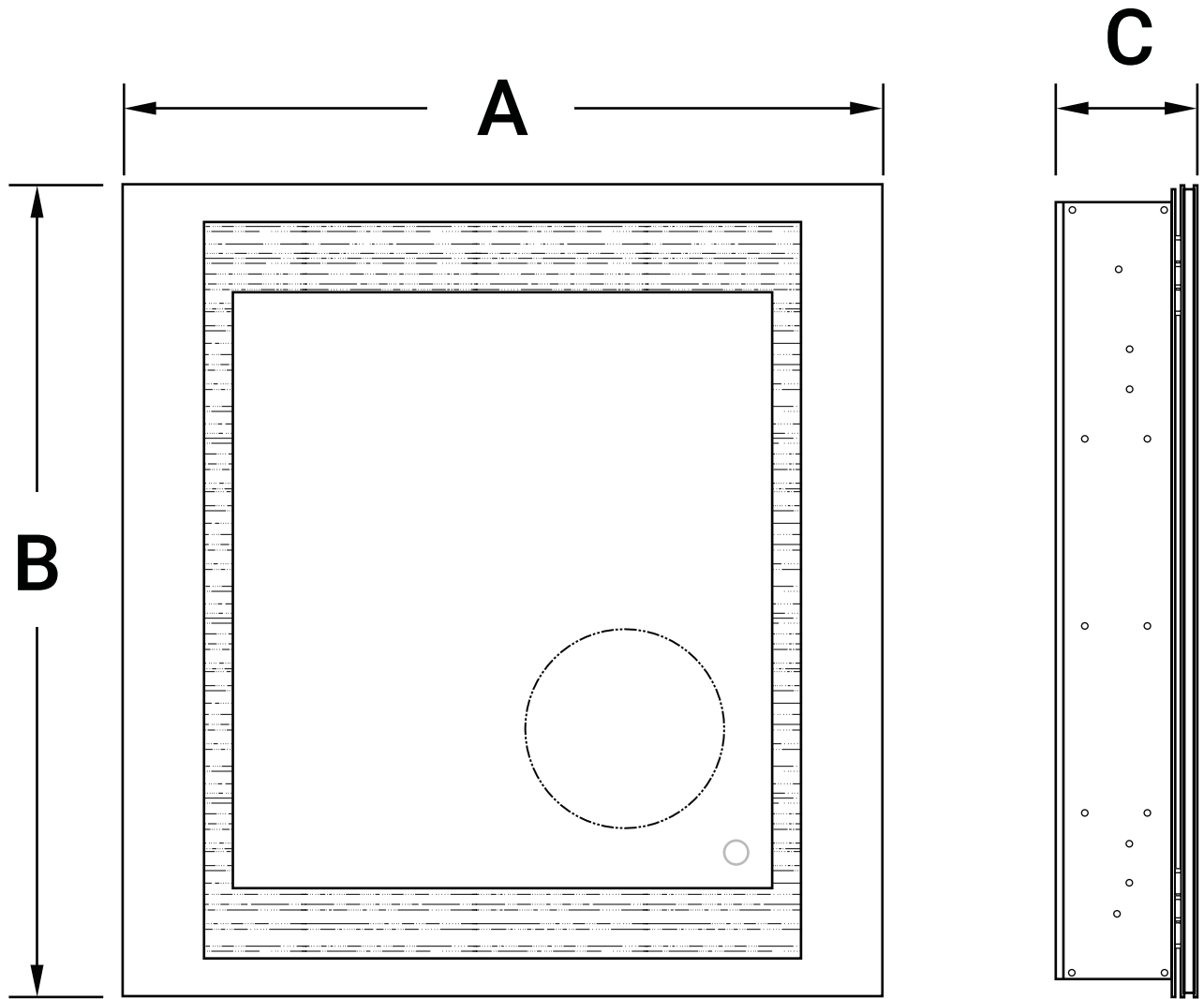

Model#	A	B	C
MM2426SLED	24	26	5 1/4

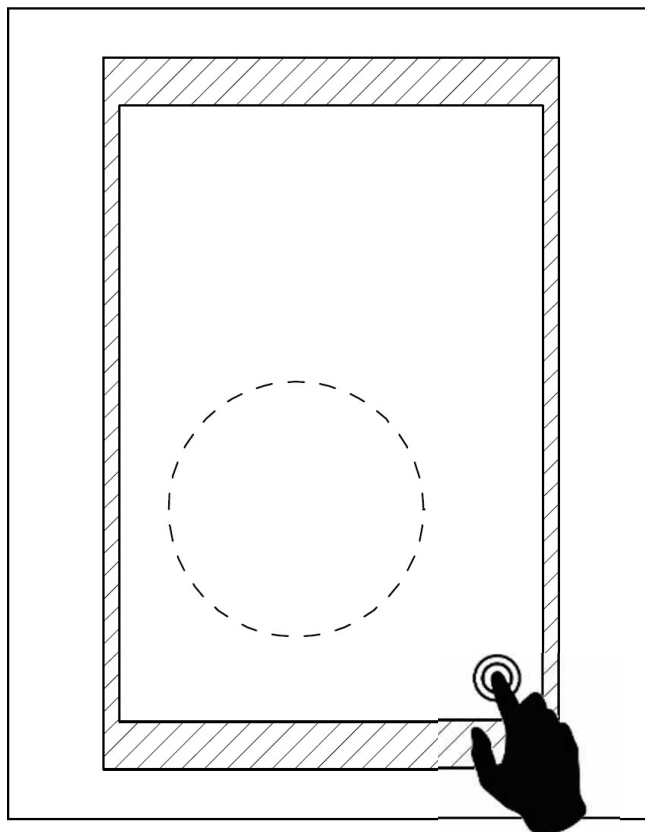

1. Touch switch
 - a. Press the switch once to turn on/off the LED lights.
 - b. When the lights are on, press and hold the switch for about 3 seconds to change the color temperature.

CARE AND MAINTENANCE

Clean the mirror with a soft, damp cloth and dry thoroughly with a soft towel. Do NOT allow the edges of the mirror to get or remain wet over a period of time. Please do NOT use glass cleaner that contains ammonia or vinegar. Never spray any cleaner directly onto a mirror. Instead apply the cleaner to a soft cloth and then wipe the mirror. Make sure no commercial cleaner comes in contact with the edge or backing.

WARRANTY

DEFECTIVE GOODS CONSUMER WARRANTY

Miseno inspects all of its products prior to shipment. We offer a 5-year Limited warranty on our electric mirror products. Defective products should be returned to place of purchase for replacement. However, if this is not possible, we accept returns on defective product with our written authorization. Returns will be handled by product replacement. Defects or damage caused to the product by the consumer do not qualify for warranty replacement.

SHORTAGE OR DAMAGED PRODUCTS

All shipments are carefully inspected and counted before leaving our distribution centers. Please inspect carefully on receipt of merchandise, noting any discrepancy or damage on the carrier's freight bill at that time, and file a claim with the carrier within 10 days from receipt of order. Then contact our office. Deductions from invoices for shortages or damage claims will not be allowed.

RETURN NEW GOODS

All claims for returns or adjustments must have prior approval and return authorization (RMA) number. Only original, sealed product in salable condition are eligible for a general return. Credit for authorized general returns will be issued at the net price paid for the product and may be subject to a 15% restocking/handling fee. Merchandise is to be returned via prepaid freight. All unauthorized returns will be refused or subject to a 25% restocking/handling fee.

REPLACEMENT PARTS

Part	Description
1	Mirror Door
2	LED Light
3	Cover
4	Hinge
5	AC & USB Outlets
6	LED Driver
7	Electrical Cover
8	Backboard
9	Aluminum Frame
10	Glass Shelf
11	Touch Switch

