

PACKAGE CONTENTS

ISSUED 05-2014

UM-TST2318D2

PART	DESCRIPTION	QUANTITY
A	Inner Backplate (Pre-assembled to fixture body)	1pc
B	Green Ground Screw (Pre-assembled to Inner Backplate)	1pc
C	Wire Connector	3 pcs
D	Outlet Box Screw	2 pcs
E	Mounting Screw (Pre-assembled to fixture body)	4 pcs
F	Shade	4pcs
G	Fixture Body	1pc

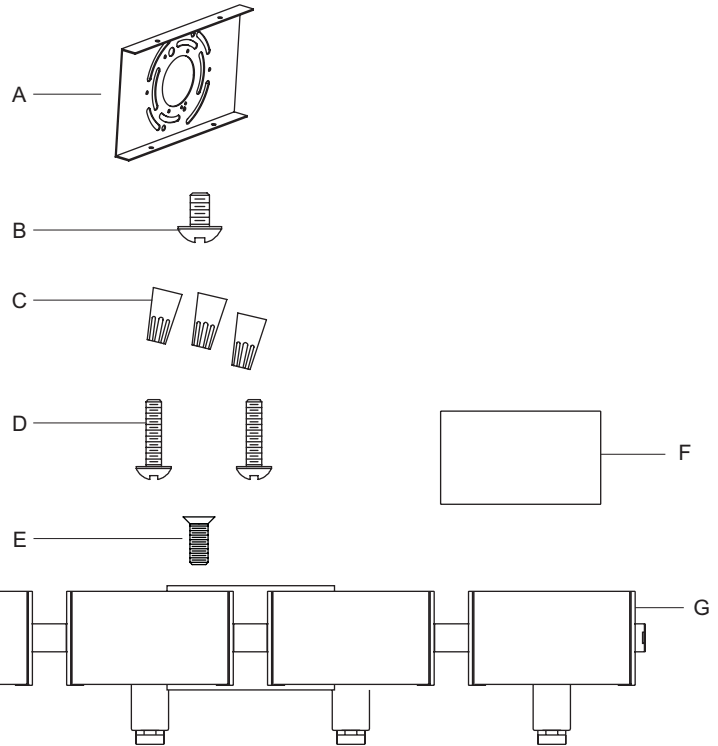

WARNINGS AND CAUTIONS

WARNING:

- Before beginning the installation, turn off electricity at the circuit breaker box or the main fuse box by switching off the circuit breaker or removing the fuse.

CAUTION:

- These instructions are provided for your safety. It is very important that they are read completely before the installation of your fixture. We strongly recommend that a professional electrician install the fixture.
- Disconnect fixture from the power source before replacing the bulb(s), making sure that bulb(s) had sufficient time to cool down. DO NOT subject the lamp to any shock while lit as shattering of lamp may result.
- Do not touch the bulb with bare hands use a cloth or glove.

PREPARATION

- Before beginning installation of product, make sure all parts are present. Compare parts with package contents list and diagram above. If any part is missing or damaged, do not attempt to assemble, install or operate the product. Contact customer service for replacement part.
- Estimated Assembly Time: 20 - 30 minutes
- **Bulb Recommended:** (4) Medium Base 60W Maximum.
- **Tools Required:** Flathead screwdriver, Phillips screwdriver, pliers, wire cutters, wire strippers, electrical tape, safety glasses.

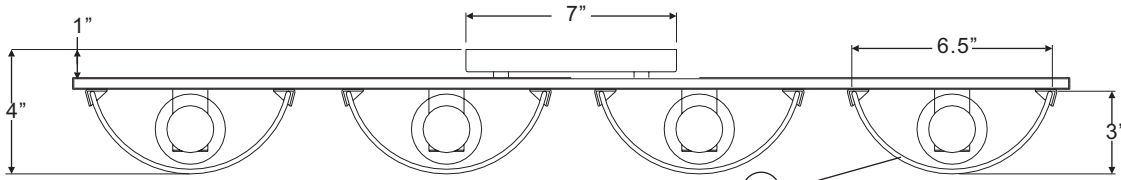

1

Outlet Box Center

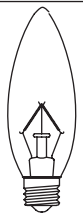
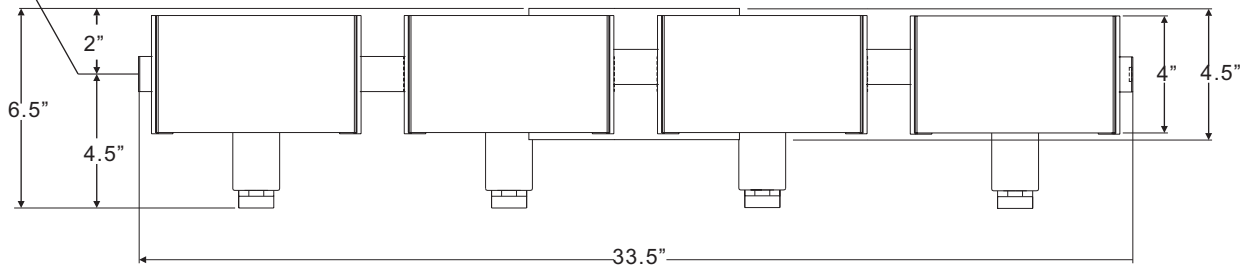

(4) 60W Medium base bulbs (not Supplied)

NOTE: ALL DIMENSIONS ARE ROUNDED UP TO THE NEAREST 1/2"

NO.	PART NUMBER	REPLACEMENT PART DESCRIPTION	REQ.
1	G3893SH	Shade	4

INSTALLATION INSTRUCTIONS

STEP 1:

Note: Prior to installation, close or cover the sink drain and/or any vents near the installation site to prevent loss of mounting hardware if dropped.

- a. Remove the Inner Backplate from the Backplate on the Fixture Body as shown in STEP 3.

- b. Secure the Inner Backplate to the outlet box (not included) with Outlet Box Screws.

Note: Fixture body can only be installed according to the orientation shown in the illustration on Step 3, sockets facing up. The Inner Backplate should be adjusted accordingly to match the holes on the backplate of the Fixture Body.

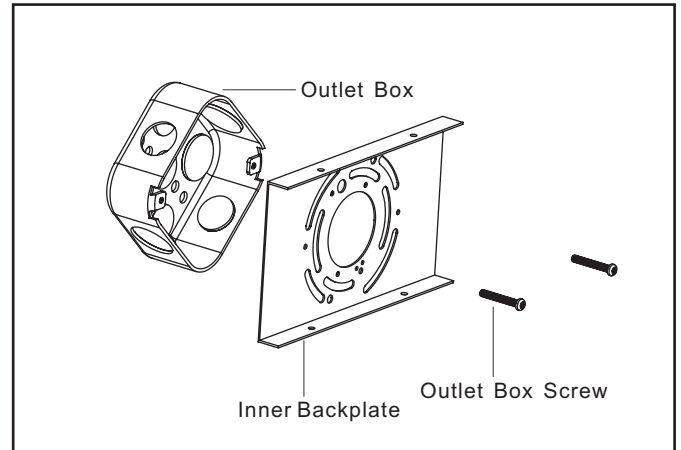

STEP 2:

* Use Wire Connectors (supplied) to connect the wires.

- a. Connect the House Ground Wire to the Fixture Ground Wire.
- b. Connect the House White (or Ribbed) Wire to the Fixture Supply Wire (White or Ribbed Side).
- c. Connect the House Black (or Red) Wire to the Fixture Supply Wire (Black or Smooth Side).
- d. Wrap each connection with approved electrical tape and carefully stuff all of the connected wires into the Outlet Box.

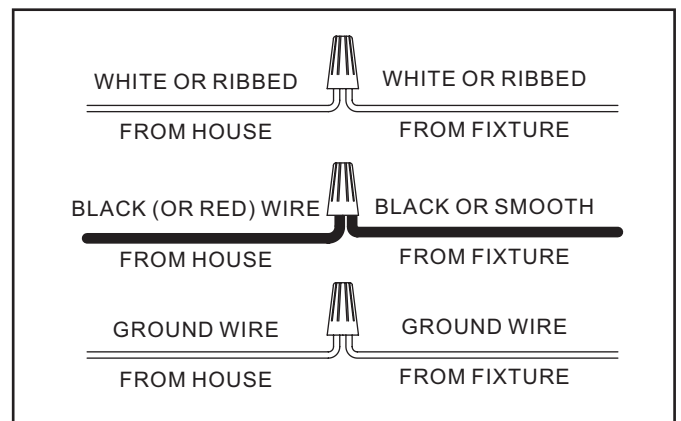

STEP 3:

- a. Carefully tuck all wires into the outlet box and position the Fixture Body over the outlet box. Line up holes on the Backplate and mounting holes on the folded edge of the Inner Backplate. Secure by threading Mounting Screws into the mounting holes on the Inner Backplate. Thread screws into top first. Do not fully tighten. Thread screws into bottom, tighten bottom screws with screwdriver. Then tighten top screws with screwdriver.

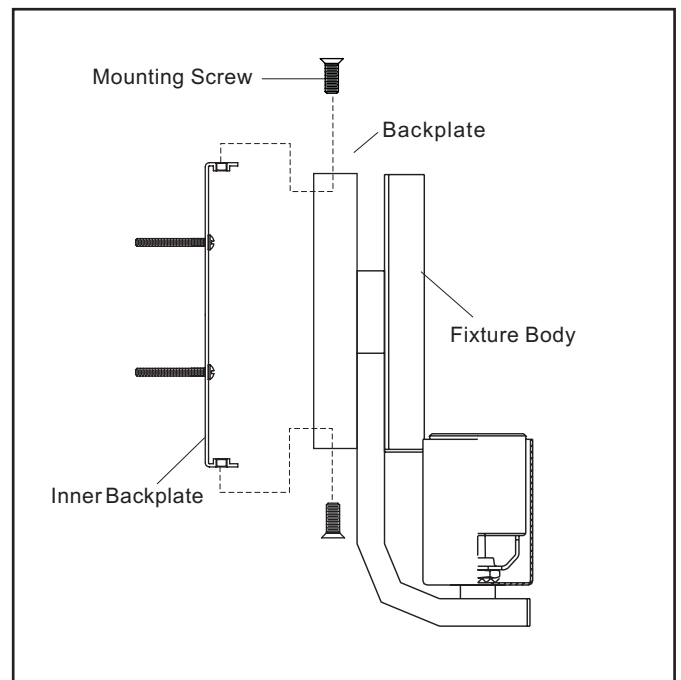

INSTALLATION INSTRUCTIONS

STEP 4:

- a. Insert Shade into the Slot of Fixture Body properly.

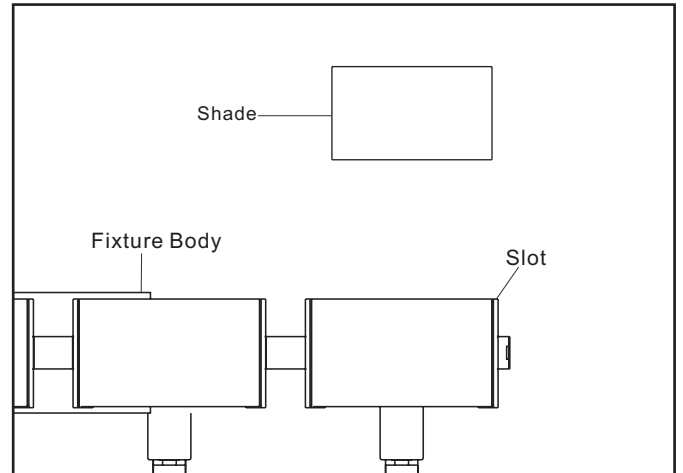

STEP 5:

- a. Install correct bulbs referring to fixture markings and/or labels for maximum wattage.

Your installation is completed now. Restore electricity. Retain this sheet for future reference.