

# INSTALLATION INSTRUCTIONS

Item#4094-66A/84 (New. 02/02/2021)

## READ AND SAVE THESE INSTRUCTIONS

**WARNING! SHUT POWER OFF AT FUSE OR CIRCUIT BREAKER.**

**AVERTISSEMENT! COUPER LE COURANT AU NIVEAU DES FUSIBLES OU DU DISJONCTEUR.**

### MOUNTING THE FIXTURE (Fig.1)

1. Shut off power at the fuse box or circuit breaker box and remove the old fixture including the mounting hardware.
2. Carefully unpack your new fixture and lay out all the parts in a clear area. Take care not to misplace any small parts necessary for installation.
3. Attach the mounting plate (A) to the outlet box using the outlet box screws (C) (SIZE: #8-32N, L0.5"). Then adjust the length of mounting screws (B) and tighten with hex nuts. The side of the mounting plate (A) marked "GND" must face out.

### CONNECTING THE WIRES (Fig.2)

4. At this point, connect the electrical wires as shown in Fig.2, making sure that all wire connectors (W) are secured. If your outlet box has a ground wire (green or bare copper), connect the fixture's ground wire to it. Otherwise, connect the fixture's ground wire directly to the mounting plate (A) using the green screw provided. After the wires are connected, tuck them carefully inside the outlet box.

### FINISHING THE INSTALLATION (Fig.1)

5. Place the backplate (D) through the mounting screws (B) on the mounting plate (A) and fix it with finials (E).
6. Unscrew the socket ring (H) from the fixture socket (F). Position the glass shade (G) onto the fixture and secure in place with the socket ring (H).
7. Install (4) four medium base (E26) bulbs (I) up to 60 watts each or CFL or LED equivalent (not included) in accordance with the fixture specification—**DO NOT EXCEED THE MAXIMUM WATTAGE RATING! (NE PAS DEPASSER LA PUISSANCE NOMINALE MAXIMALE!).**

Your installation is now complete. Return power and test the fixture.

Fig.1

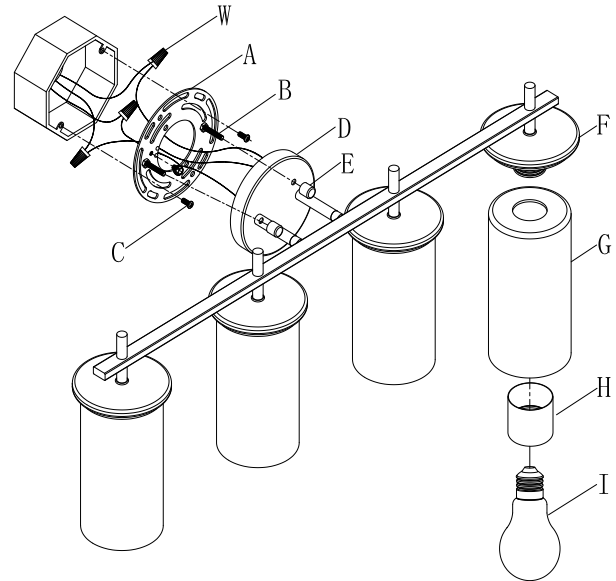

Set# A020-102

-Mounting Plate

-Ground Screw

-Mounting Screw\*2

Fig. 2

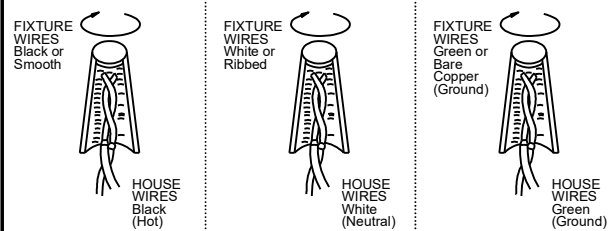

**Note: Illustration (Fig.1) on this manual is for installation purposes only. It may or may not be identical to the fixture purchased.**