

INSTALLATION INSTRUCTIONS

Item#2172-66A/84 (New. 02/02/2021)

READ AND SAVE THESE INSTRUCTIONS

WARNING! SHUT POWER OFF AT FUSE OR CIRCUIT BREAKER.

AVERTISSEMENT! COUPER LE COURANT AU NIVEAU DES FUSIBLES OU DU DISJONCTEUR.

MOUNTING THE FIXTURE (Fig.1)

1. Shut off the power at the fuse box or circuit breaker. If necessary, remove the old fixture, including the mounting hardware.
2. Carefully remove the fixture from the carton and check that all parts are included as shown in the illustration.

ASSEMBLING THE FIXTURE WITH CHAIN LOOP (Fig. 2)

3. Twist the chain holder (C) into the nipple of the mounting strap (A) and adjust the length of the nipple when necessary.
4. Twist the chain loop (G) to the top of the fixture and tighten.
5. Determine the desired hanging height and use a pair of proper chain pliers to remove and discard the excess chain.
6. Open one end of chain (F) and attach it to chain loop (G) and close the chain (F). Slip the lock collar (E) and canopy (D) over the chain (F) and allow them to rest on the fixture body.
7. Carefully lace the fixture's wires through the chain (F). Feed the fixture wires through the chain loop (G), lock collar (E) and canopy (D) assembly.
8. Attach the mounting strap (A) to the outlet box using outlet box screws (B) (Size: #8-32N*L0.5"). The side of mounting strap (A) with "GND" marked must face out.

CONNECTING THE WIRES (Fig.2)

9. At this point, connect the electrical wires as shown in Fig.2, making sure that all wire connectors (W) are secured. If your outlet has a ground wire (green or bare copper), connect the fixture' ground wire to it. Otherwise, connect the fixture's ground wire directly to the mounting strap (A) using the green screw provided.
10. Tuck the wire connectors (W) neatly into the ceiling outlet box.

FINISHING THE INSTALLATION (Fig.1)

11. Raise the canopy (D) all the way to the ceiling. Thread canopy (D) into the chain holder (C) and lock it on the ceiling with lock collar (E).
12. Unscrew the socket ring (J) from the fixture socket (H). Position the glass shade (I) onto the fixture and secure in place with the socket ring (J).
13. Install (3) three medium base (E26) bulbs (K) up to 60 watts each or CFL or LED equivalent (not included) in accordance with the fixture specification—**DO NOT EXCEED THE MAXIMUM WATTAGE RATING! (NE PAS DEPASSER LA PUISSANCE NOMINALE MAXIMALE!)**.

Your installation is now complete. Return power and test the fixture.

Note: Illustration (Fig.1) on this manual is for installation purposes only. It may or may not be identical to the fixture purchased.

Fig. 1

Set# A-016

- Mounting Strap
- Ground Screw
- Mounting Screw*2

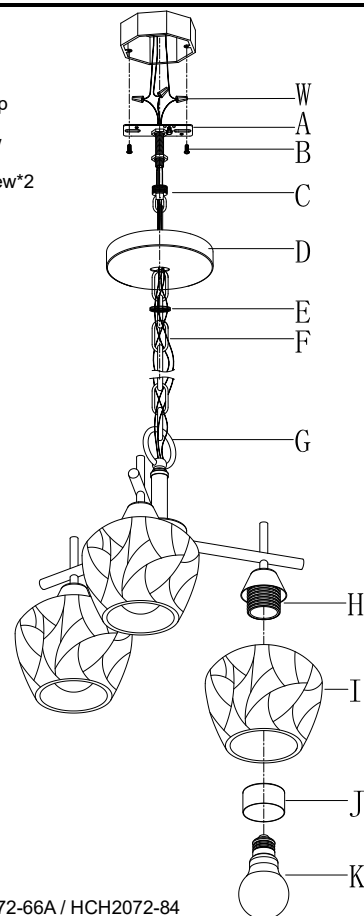

Chain# HCH2072-66A / HCH2072-84

Fig.2

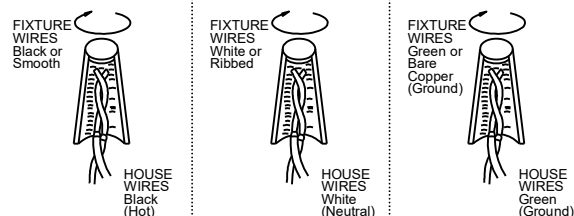

CHAIN HUNG FIXTURE INSTRUCTION

Notice: It is important to use proper chain pliers (not included) To OPEN and CLOSE the chain included with this fixture. Do not open them with other tools that may twist or stress the chain links. It is important to use proper chain pliers like the ones shown in the diagram.

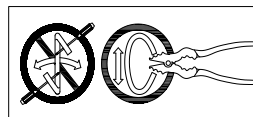
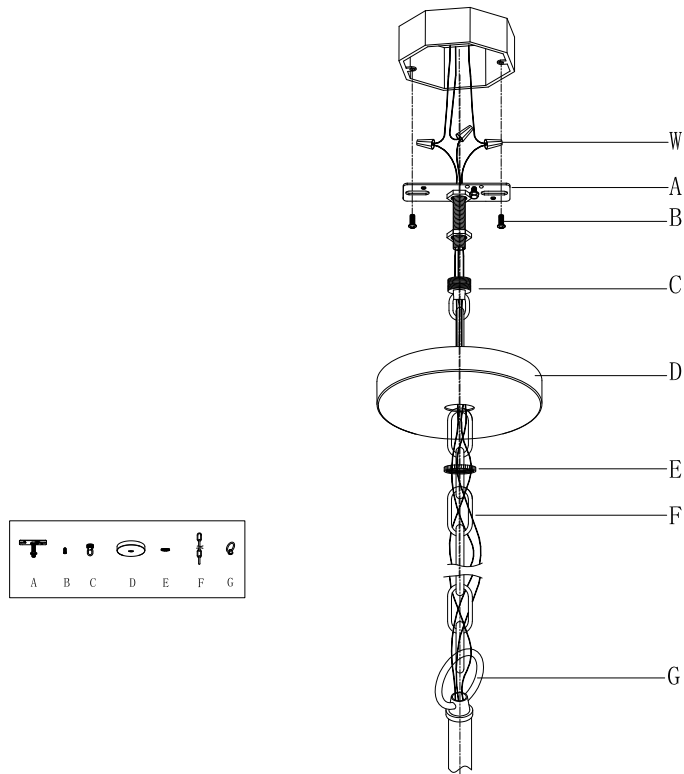
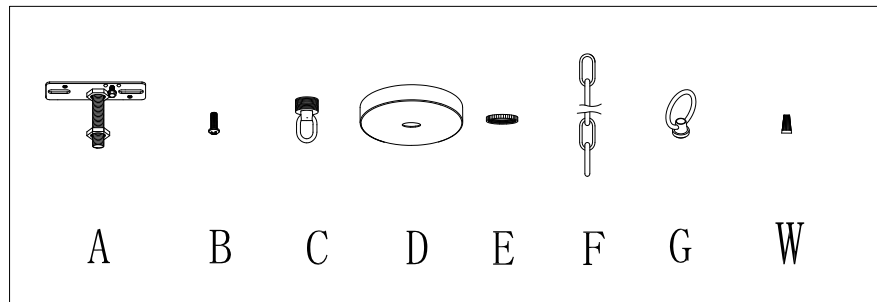

Fig.2



a. Hardware Bag:

- A. Mounting Strap*1
- B. Outlet Box Screw*2
- C. Chain Holder*1
- D. Canopy*1
- E. Lock Collar*1
- F. Chain*1
- G. Chain Loop*1
- W. Wire Connector*3



INSTALLATION INSTRUCTIONS

OPTIONAL-SEMI FLUSH MOUNT

Item#2172-66A/84 (New. 02/02/2021)

READ AND SAVE THESE INSTRUCTIONS

WARNING! SHUT POWER OFF AT FUSE OR CIRCUIT BREAKER.
AVERTISSEMENT! COUPER LE COURANT AU NIVEAU DES FUSIBLES OU DU DISJONCTEUR.

PREPARATION (Fig. 4 & Fig. 5)

1. Twist down the chain loop (G) which is used for chandelier. (Fig.5)
2. Cut down a length of wire if the wire is too long.
3. Thread canopy (M), metal washer (P), washer (Q), lock washer (R) and hex nut (S) into the nipple of the fixture. Then secure hex nut (S) by using wrench (not included). (Fig.5)
4. Attach the mounting plate (O) to the outlet box using outlet box screws (N) (Size: #8-32N*L0.5"). Then adjust the length of mounting screws (T) and tighten with hex nuts. The side of the mounting plate (O) marked "GND" must face out. (Fig.4)

CONNECTING THE WIRES (Fig. 2)

5. At this point, connect the electrical wires as shown in Fig.2, making sure that all wire connectors (W) are secured. If your outlet has a ground wire (green or bare copper), connect the fixture's ground wire to it. Otherwise, connect the fixture's ground wire directly to the mounting plate (O) using the green screw provided.
6. Tuck the wire connectors (W) neatly into the ceiling outlet box.

FINISHING THE INSTALLATION (Fig.4)

7. Raise the canopy (M) all the way to the ceiling and fix it on the ceiling with finials (L).
8. Unscrew the socket ring (J) from the fixture socket (H). Position the glass shade (I) onto the fixture and secure in place with the socket ring (J).
9. Install (3) three medium base (E26) bulbs (K) up to 60 watts each or CFL or LED equivalent (not included) in accordance with the fixture specification—**DO NOT EXCEED THE MAXIMUM WATTAGE RATING! (NE PAS DEPASSER LA PUISSANCE NOMINALE MAXIMALE!)**.

Your installation is now complete. Return power and test the fixture.

Note: Illustration (Fig.4) on this manual is for installation purposes only. It may or may not be identical to the fixture purchased.

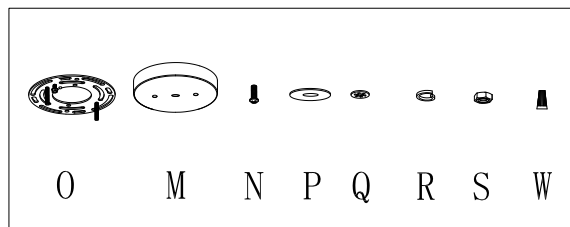

Fig. 4

Set# A020-102

-Mounting Plate

-Ground Screw

-Mounting Screw*2

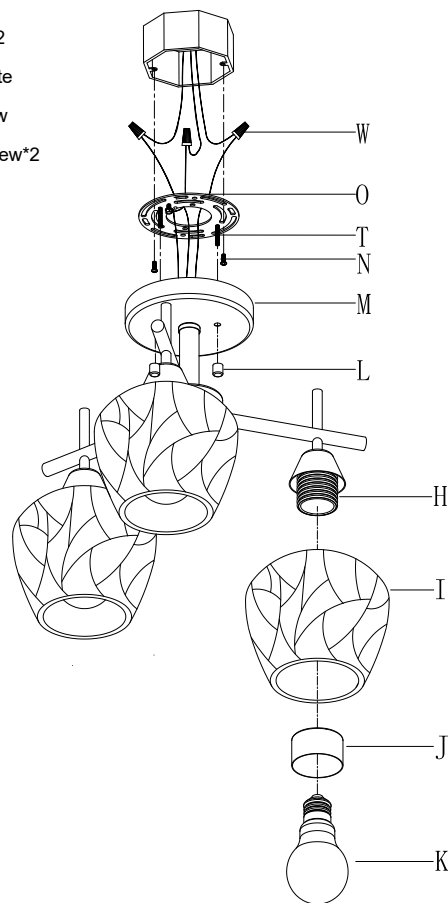
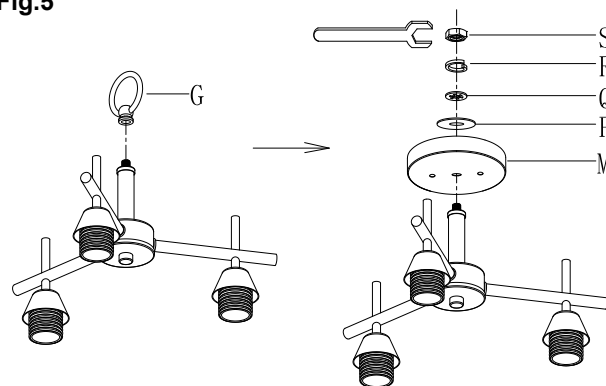

Fig.5



2172-66A/84