

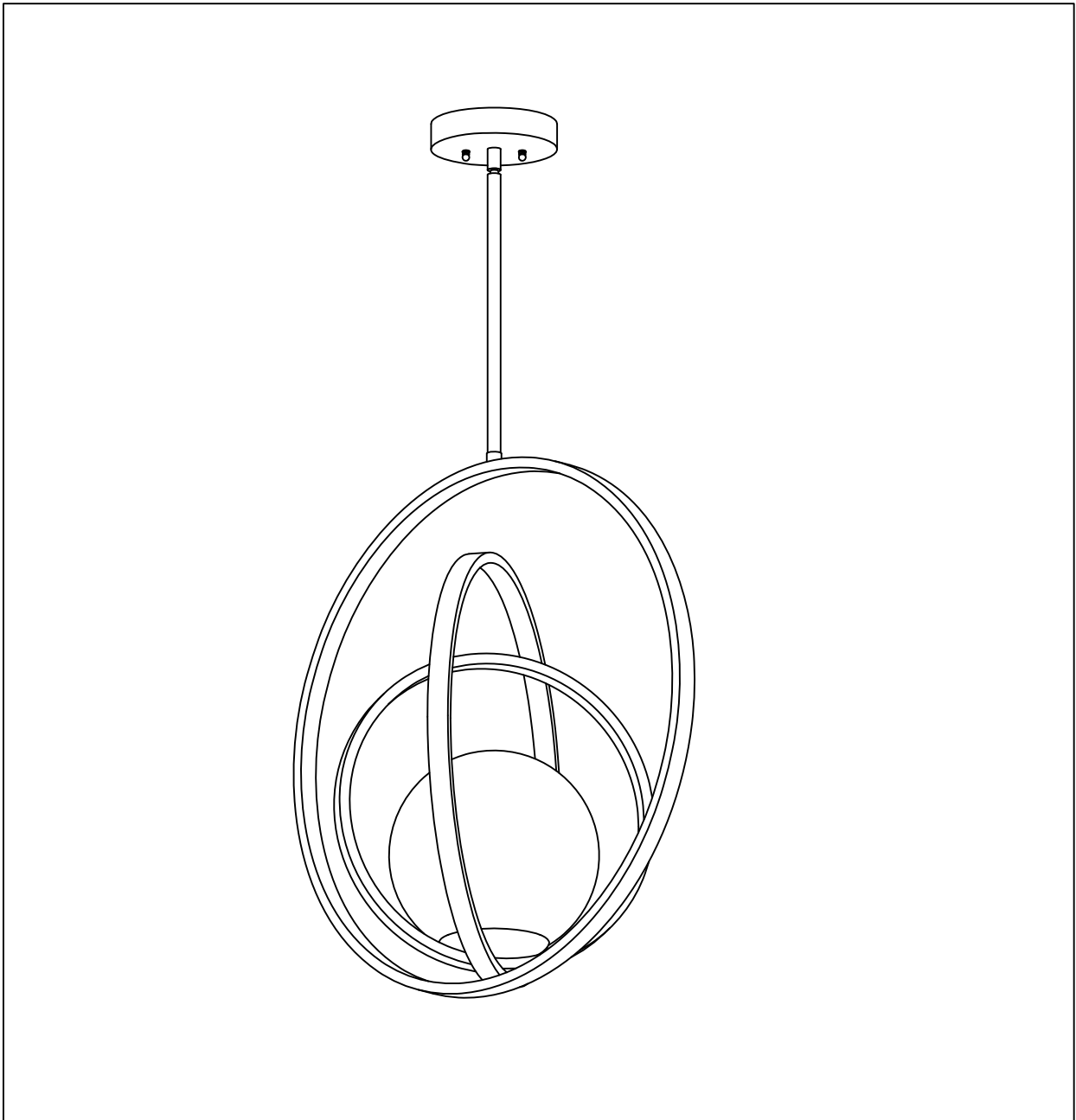

PRODUCT NAME: Coronet
ITEM NUMBER: 26054

Please consult your electrician for hanging fixture and wiring



Bulb(Not included): 1 x 60W E26 medium base

IMPORTANT: Turn off the power at the main fuse or circuit breaker box before starting installation



A
Mounting
Bracket

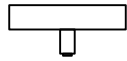

B
Canopy



C
Finial 2PCS



D1 1PC
D2 3PCS
Stems



E
Cup

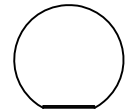

F
Glass

Locate all hardware & components before discarding packaging

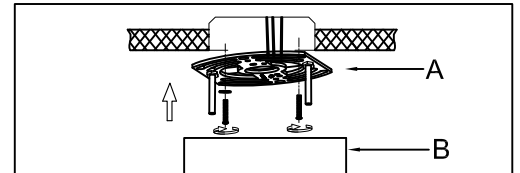
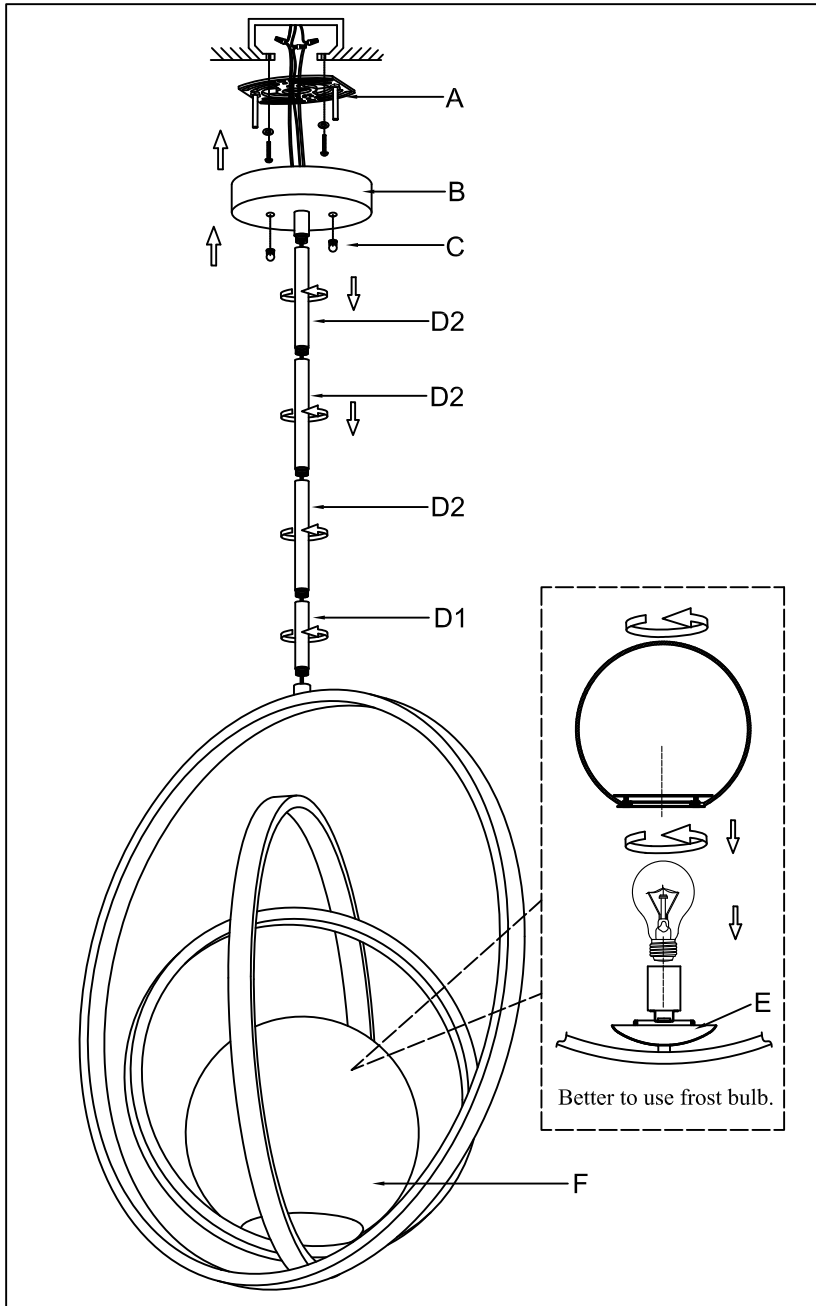

1.)
Step 1: Remove mounting bracket (A) from canopy (B) and install to electrical box.

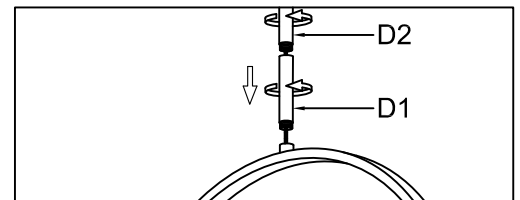

2.)
Step 2: Run wire through stem (D) lengths and combine stem lengths to meet desired mounting height. Attach the stem (D) to the body of the fixture.

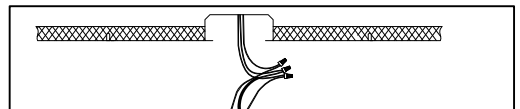

3.)
Step 3: Wire fixture to wires in outlet box. Copper wire is for Ground.

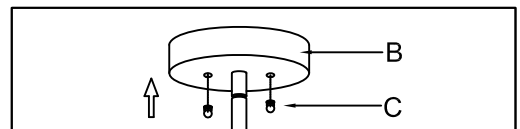

4.)
Step 4: Install fixture to bracket (A) and tighten screws at the ends of the canopy (B) to secure.

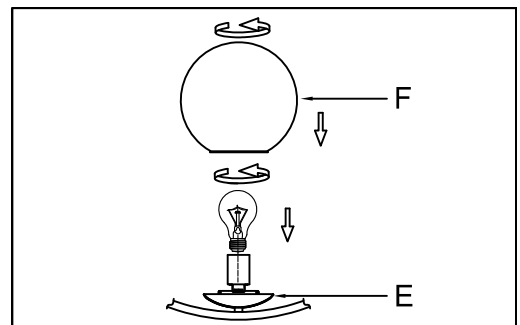

5.)
Step 5: Install 40 Watt medium base bulb E26 . Then install glass (F) into cup (E).

Cleaning & Care:

Clean with soft cloth and a mild detergent.
Do not use abrasive cleaner.