

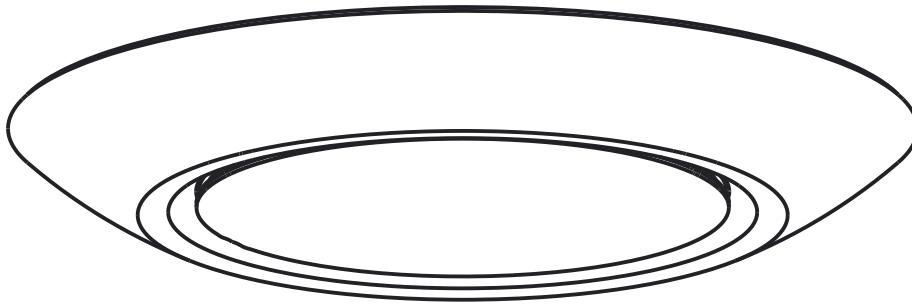

PRODUCT NAME: Diverse LED (CRI 90)
ITEM NUMBER: 57647

Please consult your electrician for hanging fixture and wiring.



WARNING:

- 1.This product must be installed in accordance with the applicable installation code by a person familiar with the construction and operation of the product and the hazards involved.
- 2.These products are designed to meet the latest NEC requirements and are classified for compliance with the applicable UL standards.Before attempting installation of any lighting fixture ,check your local electrical building code.This code sets the wiring and installation requirements for your locality and should be understood before starting your work.
- 3.RISK of fire or electric shock.
- 4.LED Retrofit kit installation requires knowledge of luminaires electrical systems . If not qualified, do not attempt installation . Contact a qualified electrician.
- 5.Install this kit only in the luminaires that have the construction features and dimensions outlined in these instructions.
6. Do not make or alter any open holes in an enclosure of wiring or electrical components during kit installation.
7. To prevent wiring damage or abrasion, do not expose wiring to edges of sheet metal or other sharp objects.

Recommended Dimmers

The fixture is designed to dim with a standard Triac forward phase dimmer. Dimming levels will vary by dimmer.

Below is a list of recommended dimmers:

- Lutron MACL-153M
- Lutron DVL-153P
- Lutron SCL-153P
- Leviton IPL06-10Z
- Leviton 6674-POW

Due to inrush current wattage should not exceed 150 watts of product for a 600 watt dimmer.

Bulbs (included):Integrated

IMPORTANT: Turn off the power at the main fuse or circuit breaker box before starting installation

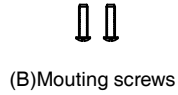
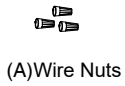

Locate all hardware & components before discarding packaging

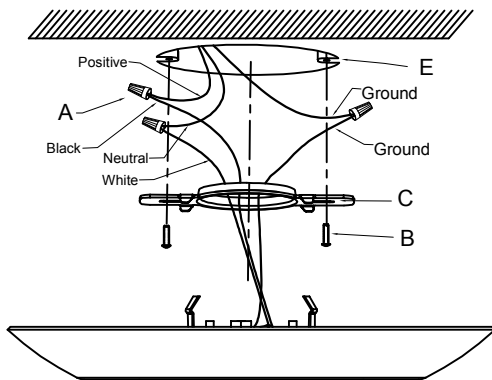

Mounting: These fixtures mount directly to most standard metallic & non-metallic electrical boxes with 2-3/4" to 3-1/2" hole spacing that are at least 1-1/2" deep. This includes 3-1/2" & 4" octagon boxes, round mud-rings for octagon and square boxes, and 3" & 4" non-metallic round boxes. Products are suitable for mounting on ceilings or walls, and are acceptable for use within closet storage spaces when installed per NEC requirements.

1.)

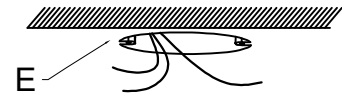

Step 1. Bring positive, neutral, and ground supply conductors (120V, 60Hz) to the room side from junction box(E).

2.)

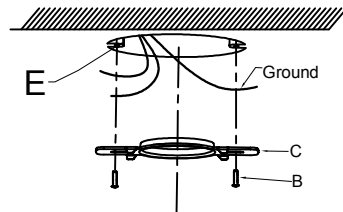

Step 2. Mount the mounting bracket (C) to the junction box(E), using mounting screws(B).

4.)

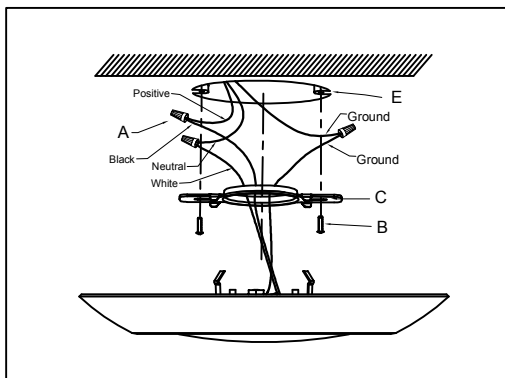

Step 4. Align fixture spring with cutout in mounting strap and press towards mounting surface to snap into place.

3.)

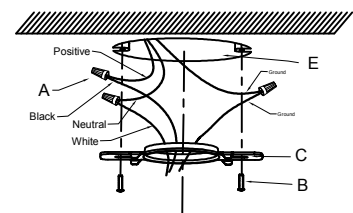

Step 3. Connect black fixture wire to positive, white fixture wire to neutral, and bare copper wire to ground using wire nuts provided.

Cleaning & Care:

Clean with soft cloth and a mild detergent.
Do not use abrasive cleaner.