

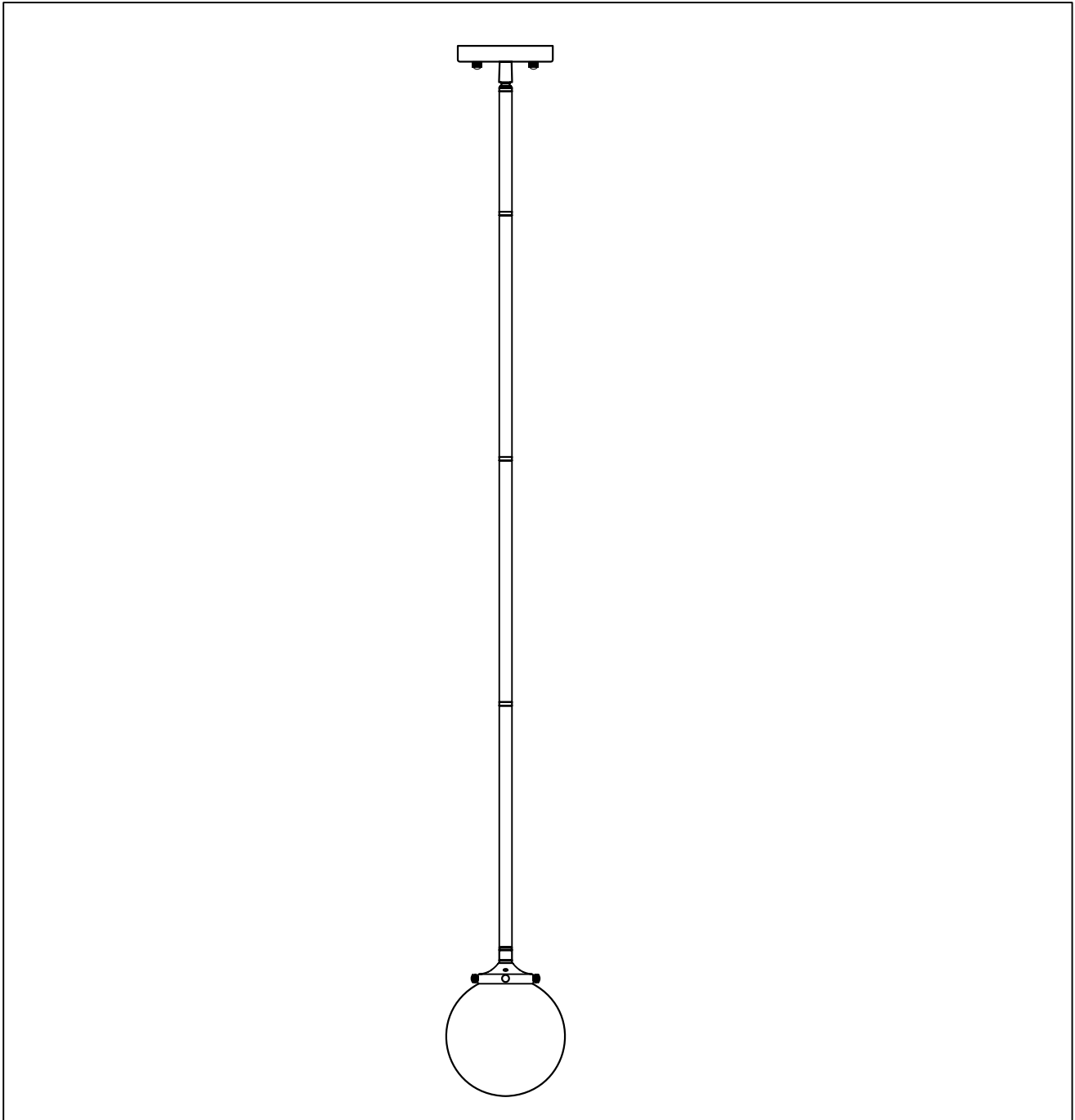

PRODUCT NAME: Atom  
ITEM NUMBER: 94720

Please consult your electrician for hanging fixture and wiring.



**Bulb(not included) E12 1 x MAX 40W**

**IMPORTANT: Turn off the power at the main fuse of circuit breaker box before starting installation**

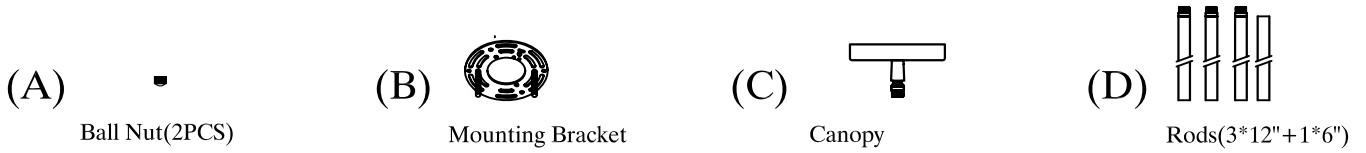

Locate all hardware & components before discarding packaging

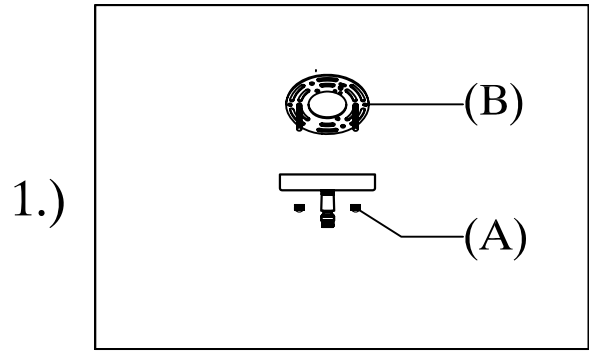
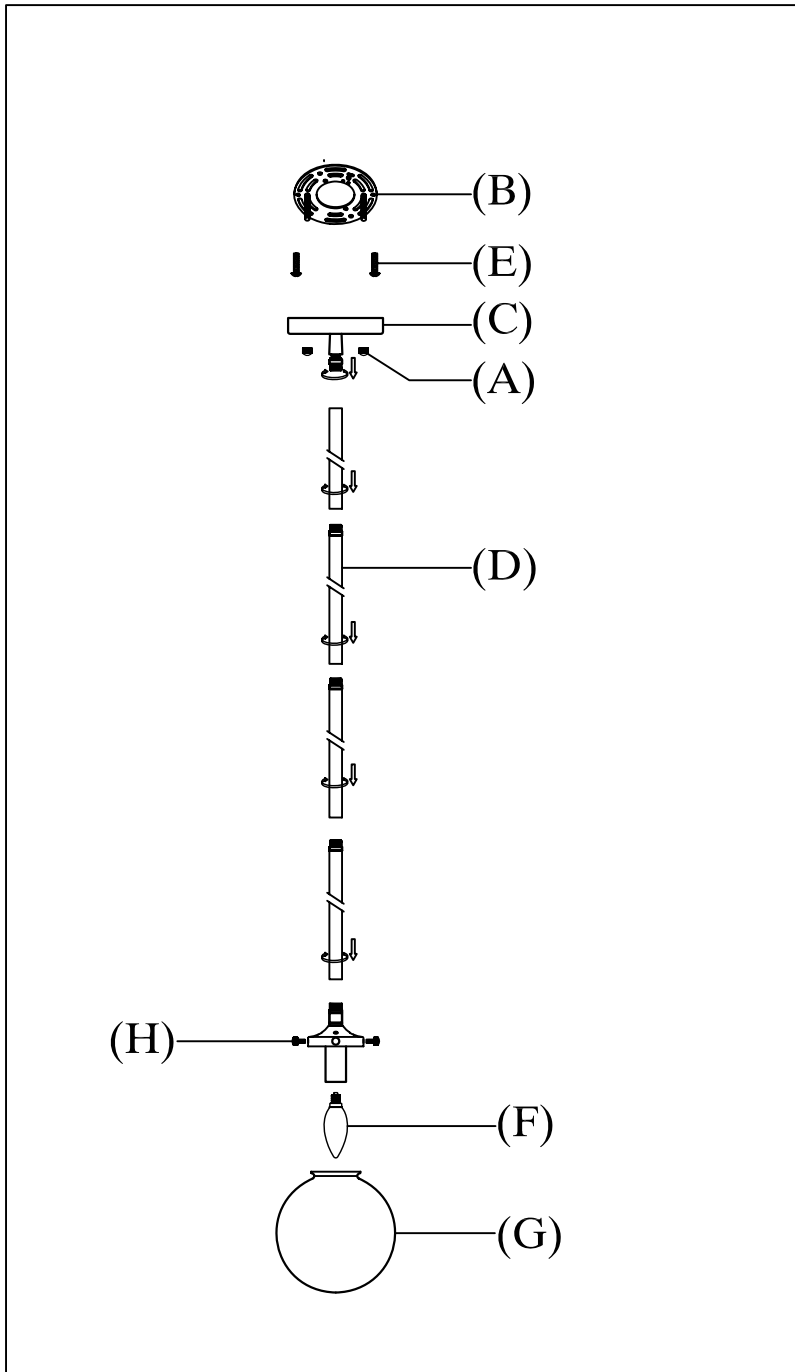

step1: Remove mounting bracket (B) from fixture and install to electrical box

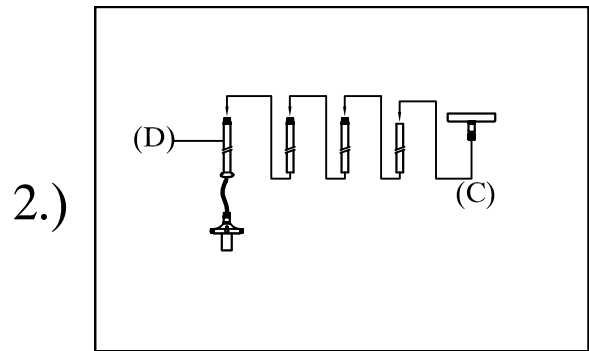

step2: Carefully remove packaging from fixture. Run wire through stems (D) and combine stem lengths to meet desired mounting height. Then attach canopy (C) to fixture.

**Cleaning & Care:**

Clean with soft cloth and a mild detergent. Do not use abrasive cleaner.

**IMPORTANT: Turn off the power at the main fuse of circuit breaker box before starting installation**

(E)   
Mounting Screws(2pcs)

(F)   
Bulb(Not Included)

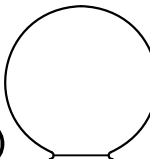
(G)   
Glass Shade

(H)   
Lock Screws(4pcs)

Locate all hardware & components before discarding packaging

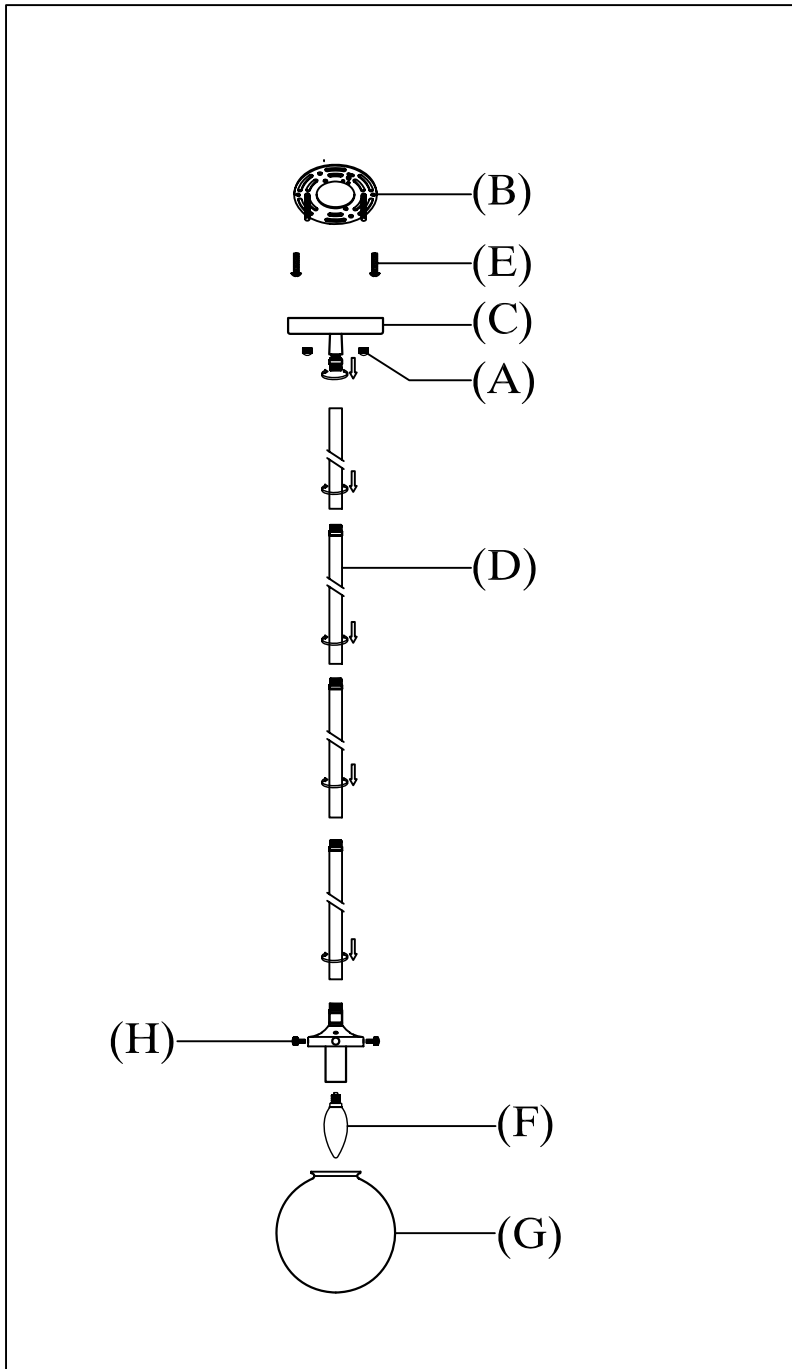

3.)

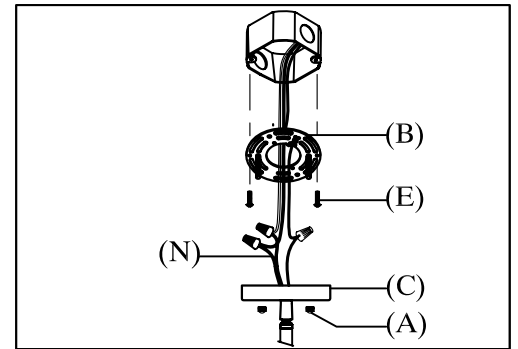

step3: Wire fixture to wires in outlet box. Copper wire in canopy is for grounding. Install canopy (C) to mounting bracket(B) using ball nuts (A) to secure.

4.)

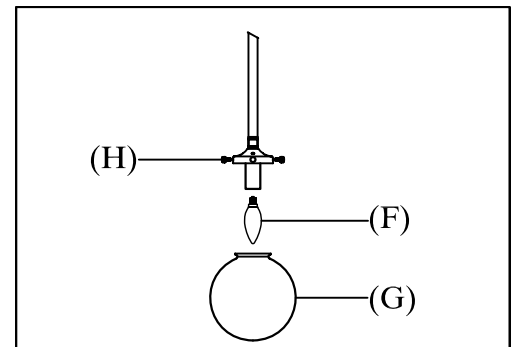

step4: Loosen the lock screws (H). Install E12 bulb(F) and attach glass (G). Secure glass (G) by tightening lock screws (H).

**Cleaning & Care:**

Clean with soft cloth and a mild detergent.  
Do not use abrasive cleaner.

MADE IN CHINA

Page 3 of (3)