

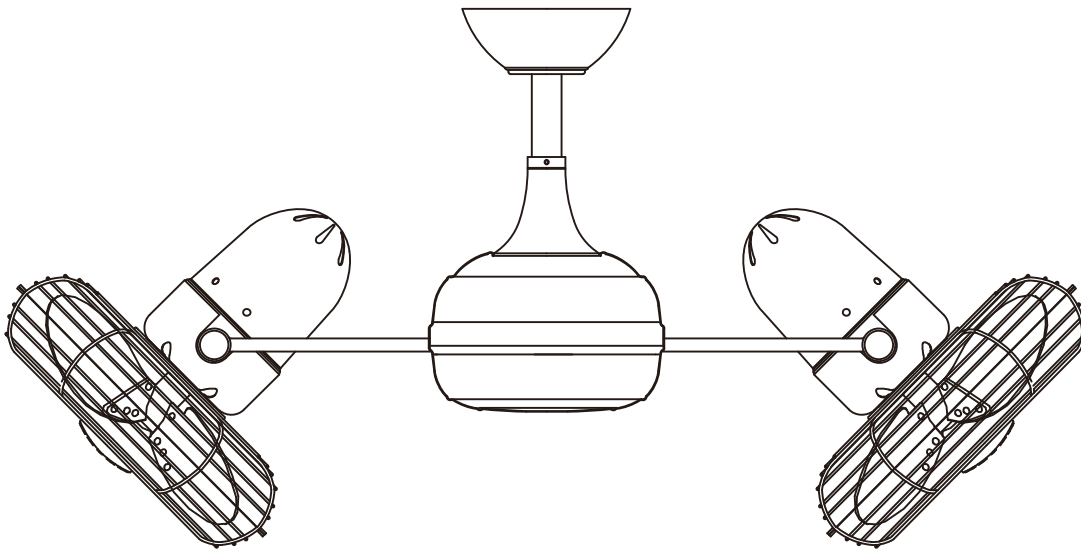

DAGNY

Ceiling Mounted Rotational Fan

READ AND SAVE THESE INSTRUCTIONS



FAN RATING AC 110V~60Hz

Please do not use any electric or battery powered tools in the assembly and installation of this or any Matthews Fan Company product.

TOOLS AND MATERIALS REQUIRED

- Philips screw driver
- Standard, flat-head screw driver
- 11 mm wrench
- Step ladder
- Wire cutters

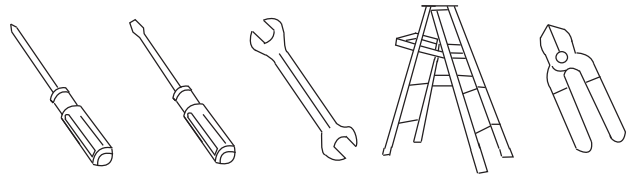

PACKAGE CONTENTS

Unpack your fan and check the contents. You should have the following items:

- Hanger bracket assembly
- Ball / down rod assembly
- Coupling cover
- Fan motor assembly
- Metal blades with cages (decorative* or safety**) (2) or Wood blades (2)
- Receiver with 5 wire nuts
- Transmitter+holder+2 mounting screws
- Allen wrench
- Package/Mounting hardware:
wood screws (2), screws (2),
lock washers (2), washers (2),
star washers (2), wire nuts (3)

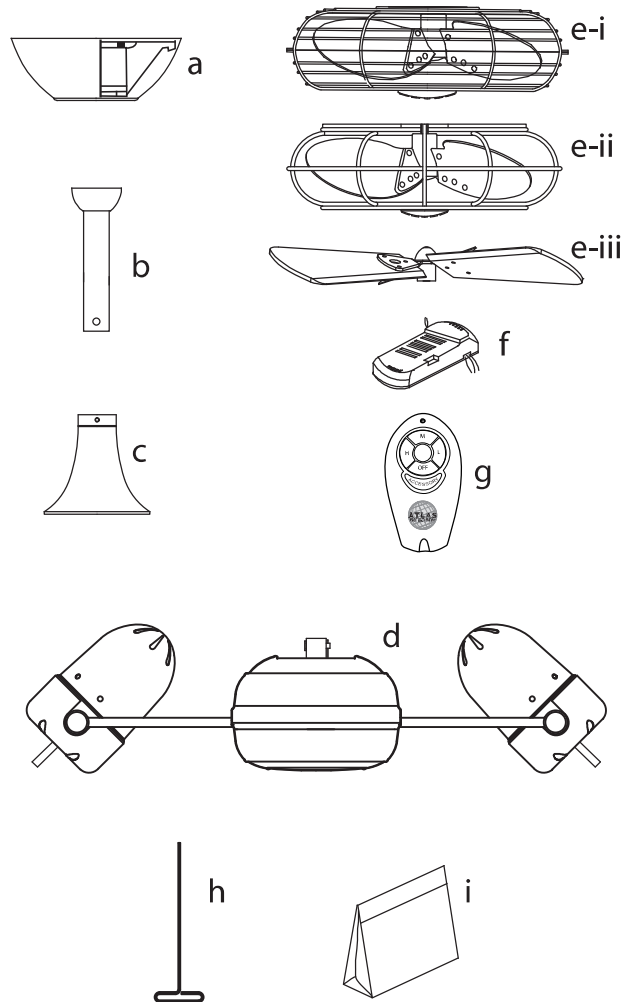

*If blades are metal and accompanied by safety cages (see Diagram e-i): To reduce the risk of injury to persons, install fan so that blades are at least 7.0 Ft. above the floor in the US and 8.3 Ft./2.5 M above the floor in Canada.

**If blades are metal and accompanied by decorative cages (See Diagram e-ii) or unguarded wooden blades (See Diagram e-iii): To reduce the risk of injury to persons, install fan so that blades are at least 10.0 Ft. above the floor in the US and 10.0 Ft./3.05 M above the floor in Canada.

READ AND SAVE THESE SAFETY AND INSTALLATION INSTRUCTIONS.

Consult a licensed electrician if unsure of any point below mentioned.
DANGER/WARNING/CAUTION

1. High voltage and moving parts around motors and motor driven equipment can cause serious or fatal injuries. Always disconnect power source at main switch before wiring, servicing or cleaning unit. Do not rely on fan control device to prevent unexpected start-up or electrical shock. In addition, power supply must have fuses or circuit breakers for short circuit protection.
2. All electrical wiring must conform to national and local electrical codes such as: NEC, OSHA, etc.
3. Fan should be secure in its electrical grounding to avoid possible electrical shock.
4. Fan should not be used in any wet or hazardous location defined by article 500 of the NEC. In addition, its ambient temperature should not exceed 104 degrees Fahrenheit.
5. Power supply should conform to voltage rating of 120V.
6. Before applying power, visually re-inspect the installation. Make sure that all guards and protective devices are securely in place and all visible screws and bolts are tightened.
7. **Warning:** To reduce the risk of fire, electric shock, or other personal injury, mount fan only on an outlet box or supporting system marked acceptable for fan support of 35 lbs (15.9 kg) or less and use mounting screws provided with the outlet box. Most outlet boxes commonly used for the support of lighting fixtures are not acceptable for fan support and may need to be replaced. Consult a qualified electrician if in doubt.
8. **Caution:** to reduce the risk of injury to persons, install fan so that bottom edges of fan blades are to be:

**In Canada, to satisfy CSA requirements: at least 8.3 Ft/2.5 M above the floor and all objects in room if safety cages are utilized. 10.0 Ft if safety cages are not utilized.
**In the US, to satisfy UL requirements: at least 7.0 Ft above the floor and all objects in room if safety cages are utilized. 10.0 Ft. if safety cages are not utilized.
9. To reduce the risk of personal injury, do not bend blades or any other part of fan when cleaning. Do not insert foreign objects in between rotating fan blades or in space surrounding entire rotating fan unit. Fan must be turned off at power at supply source before installation, cleaning or servicing.
10. Instructions for Supply Connections: Conductor of a fan identified as grounded conductor to be connected to a grounded conductor of a power supply, conductor of fan identified as ungrounded conductor to be connected to an ungrounded conductor of a power supply, conductor of fan identified for equipment grounding to be connected to an equipment-grounding conductor. After making the wire connections in junction box, the splices should be turned upward and pushed carefully into the outlet box. The wires should be spread apart with the grounded conductor and the fan-grounding conductor on one side of the junction box and the ungrounded conductor on the other side of the outlet box. Be sure that all wiring connections are properly insulated from each other and any surrounding metal parts. For safety and best operating results, we recommend that you have a qualified electrician assemble and install your fan.

11. To reduce the risk of personal injury, install the supplementary mounting means and use only the hardware provided with the fan.
12. **Warning:** TO REDUCE THE RISKS OF FIRE, ELECTRIC SHOCK OR INJURY TO PERSONS, OBSERVE THE FOLLOWING:
 - A. Use this unit only in the manner intended by the manufacturer. If you have any questions, contact the manufacturer.
 - B. Before installing, servicing or cleaning unit, switch power off at service panel and lock service panel to prevent power from being switched on accidentally.
13. **Warning:** To reduce the risk of fire, electrical shock or personal injury, mount to outlet box marked acceptable for fan support and use screws provided with outlet box.

JUNCTION BOX MOUNTING OPTIONS

Secure the outlet box directly to the building structure. Use appropriate fasteners and building materials. The outlet box and its support must be able to fully support the moving weight of the fan (at least 45 lbs.). Use a UL Listed metal outlet box. Do not use a plastic outlet box.

Figures 1, 2 and 3 are examples of different ways to mount the outlet box.

Note: You may need a longer down rod to maintain proper blade clearance when installing on a steep, sloped ceiling. (Fig. 3)

To hang your fan where there is an existing fixture but no ceiling joist, you may need an installation hanger bar as shown in Fig. 4.

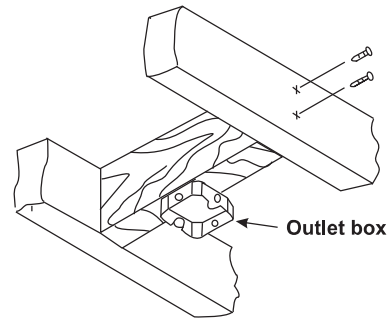

Figure 1

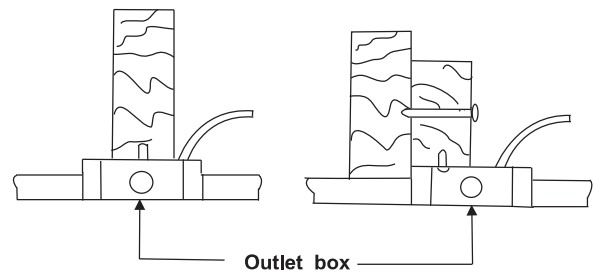

Figure 2

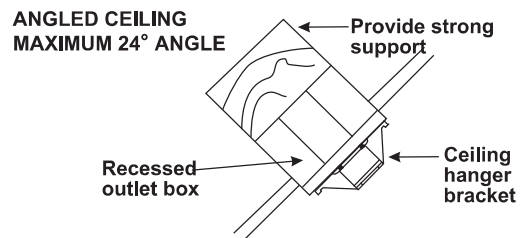

Figure 3

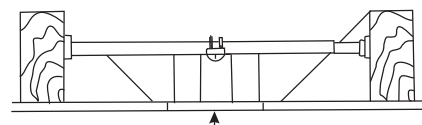

Figure 4

MOUNTING/INSTALLATION OF THE FAN

Before touching a screw driver thoroughly read these instructions.

Warning/Caution: Before installing fan, turn off power at service panel and check all visible screws and bolts for tightness.

1. Remove the decorative canopy bottom cover from the canopy by turning the cover counter clockwise. (Fig. 5)
2. Remove the hanger bracket from the canopy by removing the 1 of 2 screws from the bottom of the hanger bracket and loosening the other one a half turn from the screw head. Next, turn the canopy counter clockwise to removing the hanger bracket from the canopy. (Fig. 5)
3. Secure the hanger bracket to the ceiling outlet box using screws and washers included with your outlet box. (Fig. 6)
4. Loosen the two set screws and remove the hitch pin and lock pin from the central shaft/top coupling of the motor assembly. Doing so will allow the down rod to enter the central shaft. (Fig. 7)
5. Route wires exiting from the top of the fan motor through the coupling cover, canopy cover and canopy and then through the ball/downrod. (Fig. 7)

NOTE: Make sure that coupling cover has at least 1/8" to 1/4" clearance between it and fan motor assembly. If this clearance is not given, the fan will not rotate.

6. Align the holes at the bottom of the downrod with the holes in the collar on top of the motor housing. Carefully insert the hitch pin through the holes in the collar and downrod. Be careful not to jam the pin against the wiring inside the downrod. Insert the lock pin through the hole near the end of the hitch pin until it snaps into its locked position. (Fig. 7)

Warning/Caution: Failure to properly install lock pin as noted in step 6 could result in fan loosening and possibly falling.

7. Tighten two set screws on top of the fan motor firmly.

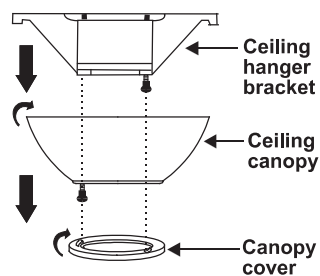

Figure 5

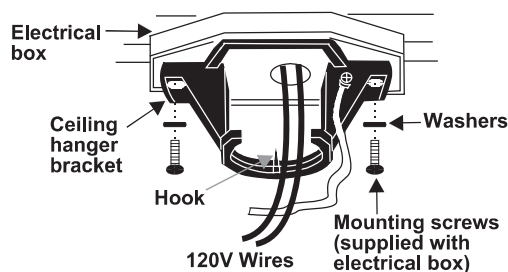

Figure 6

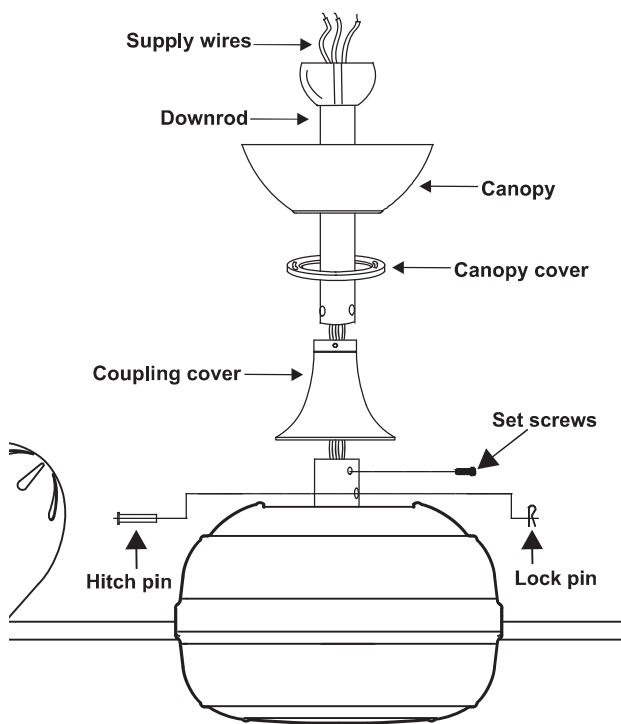

Figure 7

8 A. Metal Blades and Decorative Cages: If your fan is one with metal blades and decorative cages, remove protective plastic sleeve from the motor shafts, and then attach the metal blades and cages. Bolts to attach cages are in the hardware pack, 'i'. The Atlas medallion should be oriented correctly. Handle your blades carefully otherwise you will bend the blade irons and cause your fan to vibrate when in use. Caution: The set screw in the blade hub must be counter-sunk into the bore-hole on the flattened side of the motor shaft - or else the blades may disengage from the motor shaft during operation.

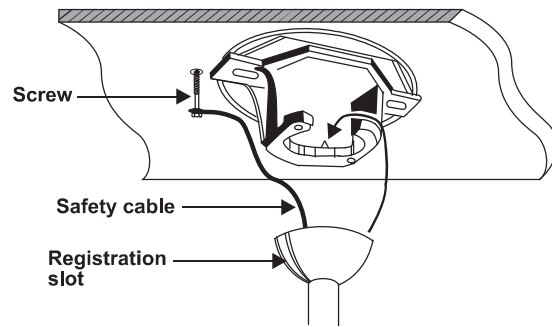

Figure 8

8 B. Metal Blades and Safety Cages: If your fan is one with metal blades and safety cages, remove protective plastic sleeve from the motor shafts, then and attach the back side of the safety cage. Bolts to attach cages are in the hardware pack, 'i'. Next, attach the blade. Handle your blades carefully otherwise you will bend the blade irons and cause your fan to vibrate when in use. Finally attach the front side of the cage with Atlas medallion oriented correctly. Caution: The set screw in the blade hub must be counter-sunk into the bore-hole on the flattened side of the motor shaft - or else the blades may disengage from the motor shaft during operation.

8 C. Wooden Blades: If your fan is one with wooden blades, attach your blades as the last step in the assembly process. Do not attach them now. **Attach them in step No.: 13.** Handle your blades carefully otherwise you will bend the blade irons and cause your fan to vibrate when in use.

9. Now lift the motor assembly into position and place the hanger ball into the hanger bracket. Rotate down rod until the "Check Tab" has dropped into the "Registration Slot" and the down rod and ball assembly seat firmly. The down rod and ball assembly should not rotate if this is done correctly.

10. An additional safety support is provided to prevent the fan from falling. Secure the safety cable to the ceiling joist with screw and washer. (Fig. 8)

11. Remove protective plastic sleeve from the motor shaft and attach your wooden blades. Ignore this step if you have metal blades, as they should already have been installed. Make sure that the set screw in the blade hub is counter-sunk into the bore-hole in the motor shaft - or else the blades may disengage from the motor shaft during operation.

MAKING THE ELECTRICAL CONNECTIONS

Warning: The power should have already been disconnected. Follow the steps below to connect the fan to your household wiring. Use the wire nuts supplied with your fan. Secure the wire nuts with electrical tape. Make sure there are no loose strands or connections.

NOTE: The Hand Held Remote Control units included with your ceiling fan are equipped with 16 code combinations to prevent possible interference from or to other remote units. The frequency switches on your Receiver and Transmitter units have been preset at the factory. Please re-check to make sure the switches on both units are set to the same positions. The frequency settings should be changed only in case of interference or if a second or more remote controlled ceiling fans are installed in the same room. Any code combination will operate the ceiling fan and light as long as the Receiver and Transmitter units are set to the same codes. (Fig. 9)

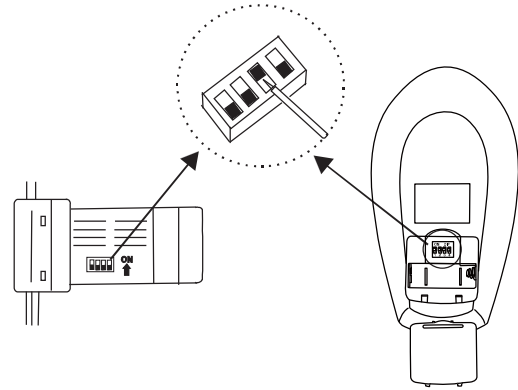

Figure 9

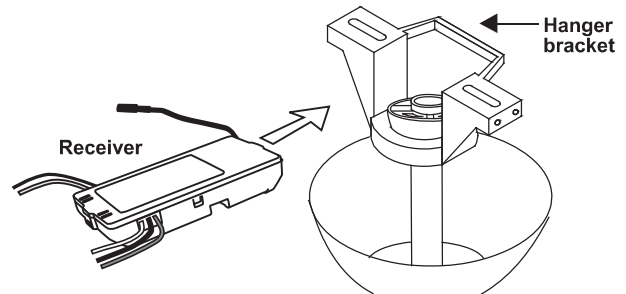

Figure 10

1. Insert Receiver into Hanger Bracket with the flat side of the Receiver facing the ceiling. (Fig. 10)

2. Motor to Receiver Electrical Connections: Connect the WHITE wire from the fan to the WHITE wire marked "TO MOTOR N" from the Receiver. Connect the BLACK wire from the fan to the BLACK wire marked "TO MOTOR L" from the Receiver. Proceed to secure all wire connections with the plastic wire nuts provided. Dagny has no light, so the blue receiver "light" wire must be capped off to avoid electrical shock. (Fig. 11)

Note: Fan must be installed from a maximum distance of 40 feet from the transmitting unit for proper signal transmission between the transmitting unit and the fan's receiving unit.

3. Receiver to House Supply Wires Electrical Connections: Connect the WHITE wire (Neutral) from the outlet box to the WHITE wire marked "AC in N" from the receiver. Connect the BLACK wire (Hot) from the outlet box to the BLACK wire marked "AC in L" from the receiver. Secure all wire connections with the plastic wire nuts provided. (Fig. 11)

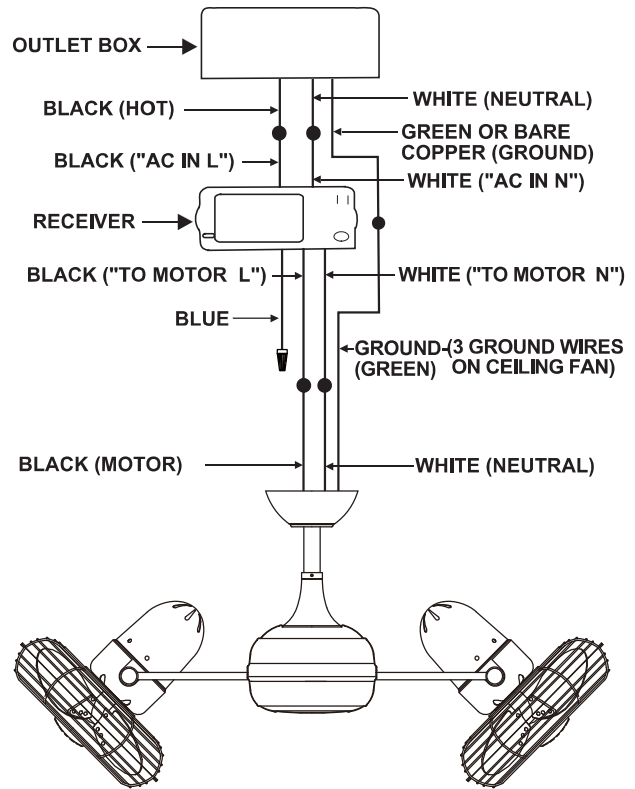

Figure 11

4. If your outlet box has a GROUND wire (Green or Bare Copper) connect this wire to the Hanger Ball and Hanger Bracket Ground wires. If your outlet box does not have a Ground Wire, then connect the Hanger Ball and Hanger Bracket Ground Wires together. Secure wire connection with the plastic wire nut provided. (Fig. 11)

5. Tuck connections neatly into ceiling outlet box.

6. Slide the canopy up to hanger bracket and place the key hole on the canopy over the screw on the hanger bracket, turn canopy until it locks in place at the narrow section of the key holes. (Fig. 12)

7. Align the circular hole on canopy with the remaining hole on the hanger bracket, secure by tightening the two set screws. Note: Adjust the canopy screws as necessary until the canopy and canopy cover are snug.

Warning: Make sure tab at bottom of hanger bracket is properly seated in groove of hanger ball before attaching canopy to bracket. Failure to properly seat tab in groove could cause damage to electrical wiring.

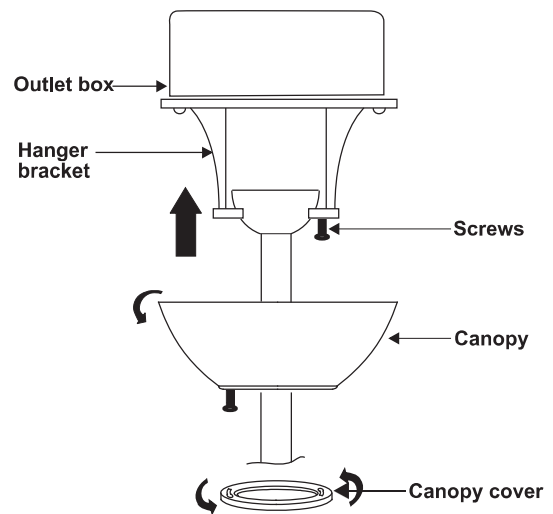

Figure 12

OPERATING THE REMOTE CONTROL

Install 12V MN21/A23 battery (included).

To prevent damage to transmitter, remove the battery if not used for long periods. (Fig. 13)

Restore Power to Ceiling Fan.

A. H, M, L Buttons:

These buttons are used to set the fan speeds as follows;

- L: Low Speed
- M: Medium Speed
- H: High Speed

B. OFF Button:

This button turns the fan off.

C. ACCESSORY Button:

Additional unused accessory circuit. This unused and accessory circuit can be used to operate another light or fan, other than the Dagny, in your room.

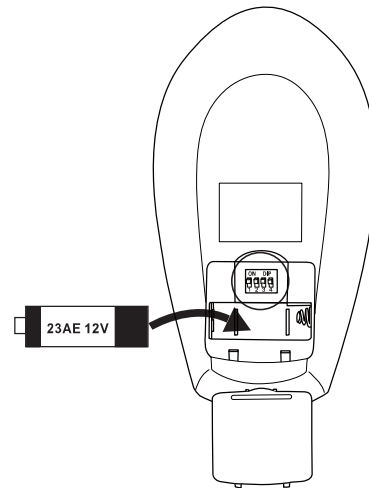

Figure 13

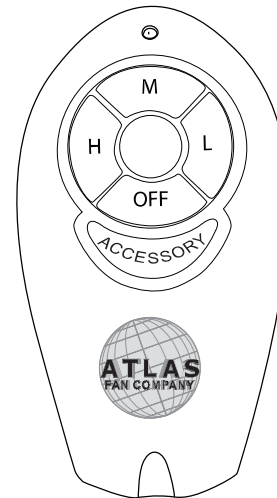

Figure 14

REGULATION OF ROTATION OF FAN UNIT

- 1. Regulate speed of fan.** The rotation of the fan can be sped up or slowed down by increasing or decreasing the power at the remote control, regulating the speed of fan heads and varying the position of the motor heads. See number 2 below
- 2. Vary position of motor heads.** The greater the angle (either up or down) of the motor heads to the horizontal support rods, the greater the speed of rotation. The less the angle of the fan head, the less the speed of rotation.

CARE OF AND TROUBLESHOOTING YOUR FAN

- 1. Check hardware bi-yearly.** Because of the fan's mechanical movement some connections may become loose over time. Check the support connections, brackets and blade attachments twice a year. Make sure they are secure. It is not necessary to remove fan from the ceiling.
- 2. Clean your fan periodically.** This will help to help maintain its new appearance over the years. Use only a lightly water-moistened, lint free cloth to avoid scratching the finish. Plated finishes are sealed with lacquer to minimize discoloration or tarnishing. Do not let rain or running water to come in contact with the fan. Rain or running water could damage the motor, wood blades or possibly cause an electrical shock.
- 3. There is no need to oil your fan.** The motor has permanently lubricated bearings.
- 4. Fan makes a vibration noise.** Check to see that all screws are tight in the fan cage connection to the motor face plate.
- 5. Fan vibrates or makes grinding noise as blades rotate.** Uninstall and reinstall the blades. Make sure that your fan head's set screw is counter-sunk into the bore hole in the flat part of the motor shaft. Be careful that the blade brackets themselves are not bent in this process. Do not operate your fan if it continues to vibrate. Contact your Atlas Fan Co purveyor if the re-installation of the blades does not resolve the problem.
- 6. Clicking noise from inside of center of fan.** As unit rotates at higher R.P.M.s, clicking noises are normally heard from the braking mechanism within the fan body. If the noise is bothersome, slow the unit down. To do this, see "Regulation of Rotation" section above.
- 7. Fan is not rotating or doing so unevenly.** See "Regulation of Rotation" section above and verify that coupling cover has at least 1/8 - 1/4" clearance between it and fan motor assembly, otherwise coupling cover will act as a brake, impeding rotation.

LIMITED LIFETIME WARRANTY

MATTHEWS-GERBAR, LTD. DBA MATTHEWS FAN COMPANY LIFETIME LIMITED WARRANTY.

Ceiling fans are warranted by Matthews-Gerbar, Ltd. to the original user against defects in workmanship or materials under normal use and inside installation for: Motors: Lifetime of original purchaser: Labor & Component parts: (lights, finish, blades, etc...): one year after date of purchase, Light Bulbs: no warranty. Any part, which is determined by Matthews-Gerbar, Ltd. to be defective in material or workmanship and returned to an authorized service location, as Matthews-Gerbar, Ltd. designates, shipping costs prepaid, will be, as the exclusive remedy, repaired or replaced at Matthews-Gerbar Ltd.'s option providing that proof of purchase is provided. For limited warranty claim procedures, see PROMPT DISPOSITION below. This limited warranty gives purchasers specific legal rights, which may vary from state to state.

LIMITATION OF LIABILITY. To the extent allowable under law, Matthews-Gerbar, Ltd.'s liability for consequential and incidental damages is expressly disclaimed. Matthews-Gerbar, Ltd.'s liability in all events is limited to, and shall not exceed, the purchase price paid.

WARRANTY DISCLAIMER. Matthews-Gerbar, Ltd. has made a diligent effort to illustrate and describe the products in this literature accurately: however, such illustrations and descriptions are for the sole purpose of identification, and do not express or imply that the products will necessarily conform to the illustrations or descriptions. **Furthermore, there is no express warranty derived from any viewed sample or model. Matthews-Gerbar, Ltd. disclaims any expressed warranty and implied warranty of merchantability and fitness for a particular use.**

Except as provided below, no warranty or affirmation of fact, expressed or implied, other than as stated in "Limited Lifetime Warranty" above is made or authorized by Matthews-Gerbar, Ltd.

PRODUCT SUITABILITY. Many states and localities have codes and regulations governing sales, construction, installation and/or use of products for certain purposes, which may vary from those in neighboring areas. While Matthews-Gerbar, Ltd. attempts to assure that its products comply with such codes, it cannot guarantee compliance and cannot be responsible for how the product is installed or used. Before purchase and use of a product, please review the product application and national and local codes and regulations, and be sure that the product, installation, and use will comply with them. **Matthews-Gerbar, Ltd. disclaims any expressed warranty and implied warranty of merchantability and fitness for a particular use if any modifications are made to the original manufacturer's product.**

Certain aspects of disclaimers are not applicable to consumer products: e.g.(a) some states do not allow the exclusion or limitation of incidental or consequential damages, so the above limitation or exclusion may not apply to you: (b) also, some states do not allow limitations on how long an implied warranty lasts, consequently the above limitation may not apply to you.

OTHER EXCLUSIONS. This warranty does not cover defects caused by: exposure to extremes of heat and humidity, neglect, modification, alteration, repair or service of the enclosed product by anyone other than an authorized Matthews-Gerbar, Ltd. service center; physical abuse to, or misuse of, the product or operation of it in a manner contrary to the accompanying instructions; or shipment of the product to a Matthews-Gerbar, Ltd. dealer or service center for service. This warranty also excludes all costs arising from adjustment of user controls, products purchased outside of the U.S.A., and costs for initial technical adjustments (set-up). Matthews-Gerbar assumes no liability for labor costs, installation costs or other losses. Consult the operating instructions included with the product for information regarding user controls.

PROMPT DISPOSITION. Matthews-Gerbar, Ltd. will make a good faith effort for prompt correction respect to any product, which proves to be defective within limited lifetime warranty. For any product believed to be defective within limited lifetime warranty, first call or write dealer from whom the product was purchased. Dealer will give additional directions. If unable to resolve satisfactorily, call Matthews-Gerbar, Ltd. at the phone number below, giving the dealer's name, address, date and number of dealer's invoice, and describe the nature of the defect. Title and risk of loss pass to buyer on delivery to common carrier. If product was damaged in transit to you, file claim with the carrier.

MATTHEWS-GERBAR, LTD.
1881 Industrial Drive - Libertyville, IL - 60048
Tel (847) 680-9043 - Fax (847) 680-8140