

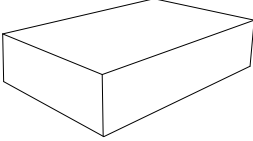









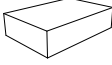







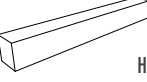

# ASSEMBLY INSTRUCTIONS

## INSET BASE BLIND CORNER | BBC36-42

PACKAGING	ITEM	ITEM CODE	QTY	PACKAGING	ITEM	DESCRIPTION	QTY	
		TOOLS REQUIRED: 1. PHILLIPS SCREWDRIVER 2. DRILL		 HARDWARE BOX		HINGES	4	
		A-1	1			CAM LOCK	10	
		A-2	1			16MM SCREW	32	
		F B	1			CAM LOCK SCREW	10	
		C	1			30MM SCREW	2	
		D	1		 DRAWER HARDWARE		SHELF HOLDER	4
		E	1				DRAWER TRACK	2
		J	1				REAR TRACK HOLDER	2
		H	2			TRACK CLIPS	2	

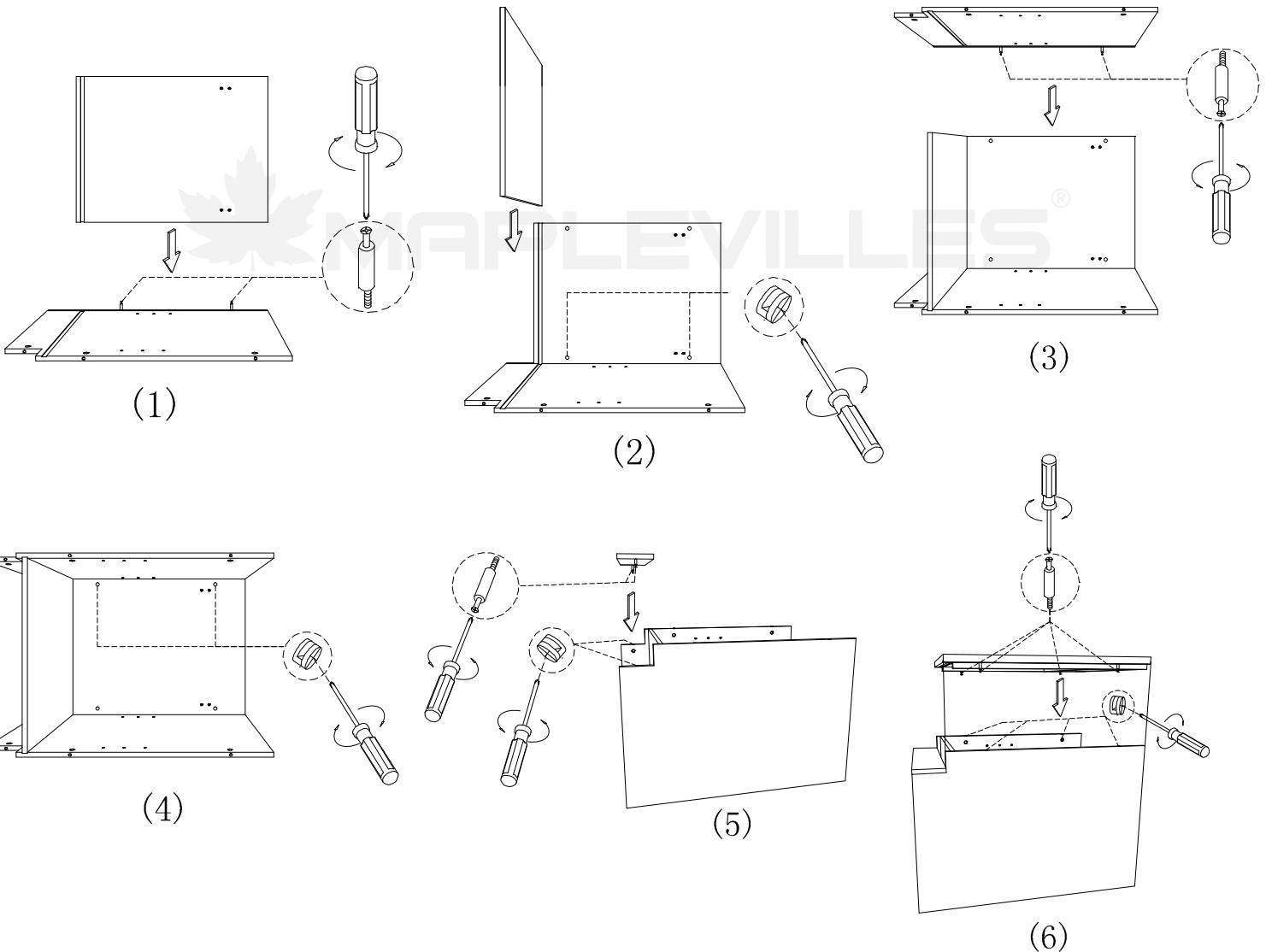

# ASSEMBLY INSTRUCTIONS

## INSET BASE BLIND CORNER | BBC36-42

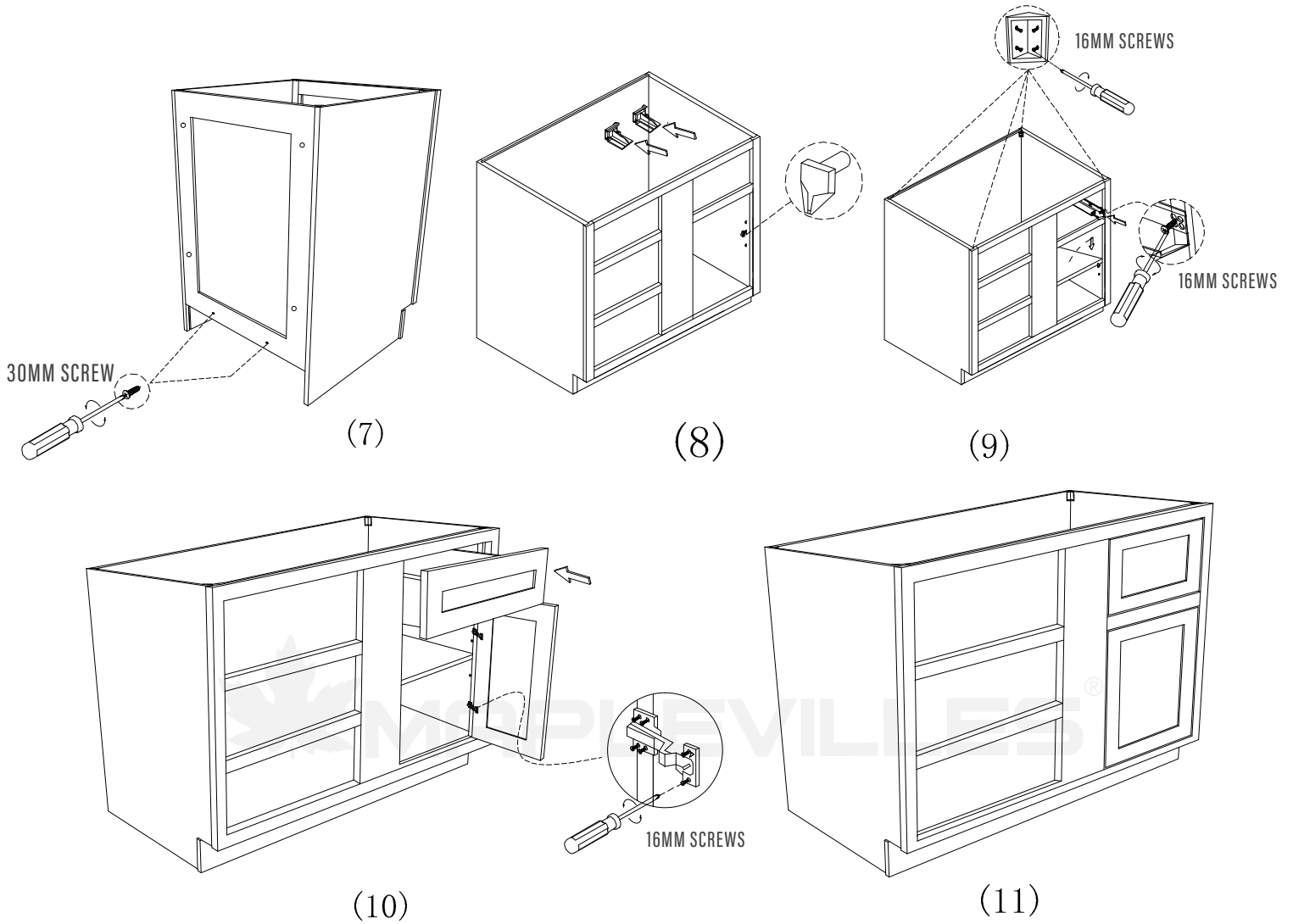

ITEM	ITEM CODE	QTY
	J-2	1
	J-3	1
	J-1	1
	J-4	1
	TRACK CLIP	2

