

---



---



---



---



---

Notes on your system

# LS-90 Installation Guide



## ⚠ Caution

- Your thermostat is a precise instrument, handle it with care.
- Turn off electricity to the HVAC system before installing or servicing thermostat or any part of the system.
- Do not turn electricity back on until work is completed.
- Do not short (jumper) across electric terminals at the control on the furnace or air conditioner to test the system. This may damage the thermostat.
- All wiring must conform to local codes and ordinances.
- This thermostat is designed for use with 24 volt AC and millivolt systems (with a separate 24VAC power adapter).
- The thermostat relay load should be limited to 1.0 amp; higher amperage may cause damage to the thermostat.

## ⚠ Caution

To avoid electrical shock and to prevent damage to the furnace, air conditioner, and thermostat, disconnect the power supply before beginning work. This can be done at the circuit breaker, or at the HVAC system.

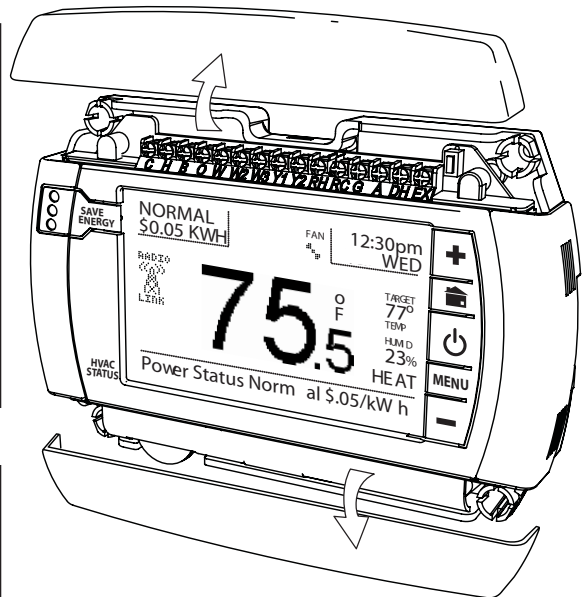

## TOOLS

You will need a small Phillips screwdriver and a drill with 3/16-in. (4.8mm) bit for wall mounts.

## LOCATION

Replacement installations - mount the LS-90 in place of the thermostat. You must have a "C" wire or other 24VAC power available at the LS-90 location. A new location will require moving your wiring. New installations and for re-locating the LS-90 - follow the guidelines listed below:

- Locate the thermostat on an inside wall, about 5 ft. (1.5m) above the floor, and in a room that is used often.
- Do not install it where there are unusual heating conditions, such as: in direct sunlight; near a lamp, radio, television, radiator register, fireplace; near hot water pipes in a wall; or near a stove on the other side of a wall.
- Do not locate in unusual cooling conditions, such as: on a wall separating an unheated room; or in a draft from a stairwell, door, or window.
- Do not locate in a damp area. This can lead to corrosion that will shorten thermostat life.
- Do not locate where air circulation is poor, such as: in a corner, an alcove; behind an open door.
- Do not install the LS-90 until all construction and painting has been completed.
- This thermostat does not require leveling.

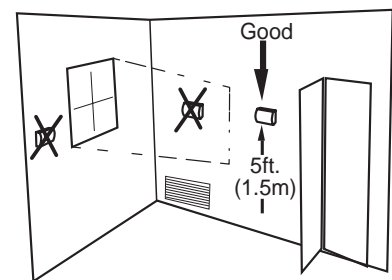

## REMOVE OLD UNIT

- ⚠ Switch OFF electricity to the furnace and air conditioner; then follow these steps.
- Remove cover from old thermostat. Most are snap-on types and simply pull off. Some have locking screws on the side or front. These must be loosened. DO NOT remove wires. Note the letters printed near the terminals. Attach labels (enclosed) to each wire for identification.

### ⚠ Caution

Read instructions carefully before removing any wiring from existing thermostat. Wires must be labeled before they are removed. THERE IS NO STANDARD COLOR CODE. When removing wires from their terminals, ignore the color of the wires and LABEL THEM by the terminal where they were screwed.

- Label the wires one at a time. You must label all the wires before you proceed. With all wires labeled, remove them from the old unit.
- Make sure the wires do not fall back inside the wall. You can wind them around a pencil to keep them from falling.
- Loosen all screws on the old thermostat and remove it from the wall.

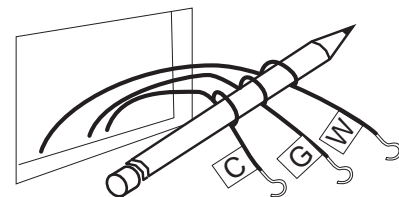

## What wires do you have?

Make sure your wires are labeled. This may require you to find the 'other end' connection for each wire on your heating or air conditioning equipment and read the label there. Refer to the Wire Reference page 13 for better understanding of wire labels from different HVAC system makers.

**⚠ IMPORTANT:** C wire or 24VAC power is required for the LS-90 to operate. If you do not have a C wire you can run a new wire from the HVAC to the LS-90 or provide 24VAC power to operate the LS-90 using a standard 24VAC wall transformer.

**⚠ IMPORTANT:** If you have both RH and RC you need to remove the metal jumper-clip between these 2 terminals.

**⚠ IMPORTANT:** If you have both O and B you must check page 13 for wiring info.

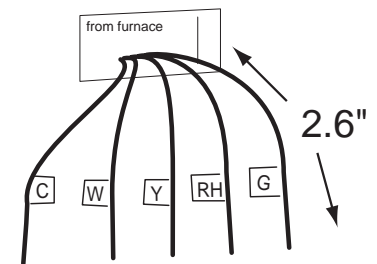
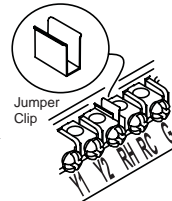

## Prepare wires

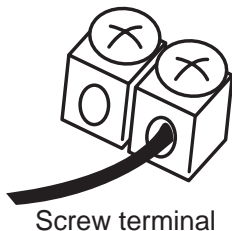

Screw terminal

Please follow these guidelines for safe and secure wire connections:

- You will need at least 2.6" of wire for each of your connections to the LS-90.
- If you do not have enough wire, splice additional wire to allow enough slack.
- Fan out wires below the hole as shown.
- Remove insulation 1/8" from the tip of each wire.
- Take care not to damage the labels for each wire in handling.

## ⚠ Caution

**Do not allow wires to touch each other or parts on thermostat.**

- Fan wires out as illustrated with LS-90 below the wall opening. As in the example: fan out the wires so that the C wire is above the C terminal the W above the W. This allows the LS-90 to fit snug to the wall.
- Wires will position behind the LS-90 and up over the terminal area.
- Do not bunch wires behind LS-90. Feed any slack back into the wall opening.

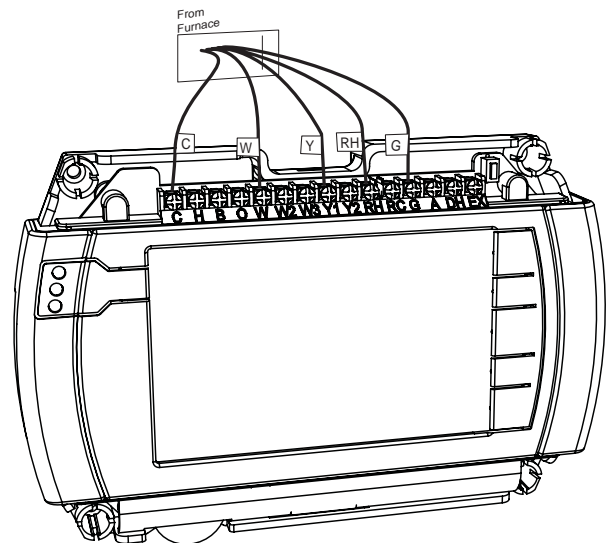

## Connect your wires

- Connect labeled wires only to a terminal with the same letter label.
- Insert the wire in the terminal well and tighten the screw securely.
- Do not over-tighten, this will cut the wire.
- If a 24VAC transformer [Radio Shack PN273-1690] is used, connect to the C and RH terminals (no polarity).

## Mount the LS-90 to wall

1. Hold the LS-90 against the wall, with the wires coming over the top above terminal block. The LS-90 will cover the hole in the wall.
2. Position LS-90 for best appearance. Use the optional stand- offs if more space for wires is needed behind the LS-90.
3. Attach the LS-90 to the wall with the screws provided.
4. If you are mounting the LS-90 to sheet rock or if you are using the old mounting holes, use the plastic anchors provided.
5. Mark first and drill a 3/16-in.(4.8mm) hole for the insert at each screw location, then mount the LS-90.

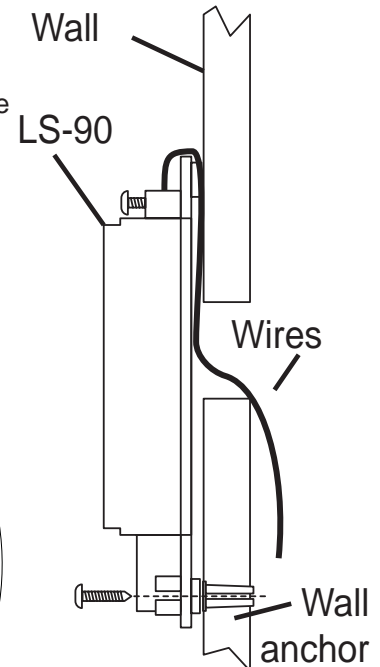
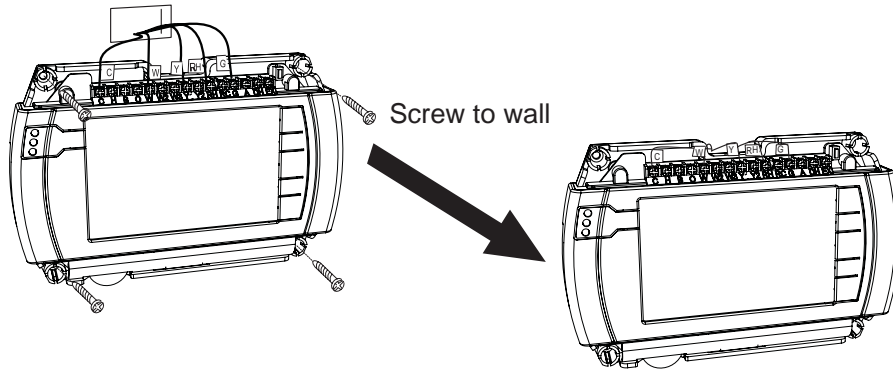

7

## HVAC Set-up on screen menu

With all the wires connected (including the C wire), it is time to turn the AC power back on. Do this at the breaker you used to switch it off. The LS-90 will power-up in the control OFF mode. Your LS-90 is not configured to operate your HVAC system yet. You must now use the menu driven HVAC SET-UP function.

**▲ IMPORTANT:** Make sure the LS-90 is powered up and is in the OFF mode before set-up. (To turn your thermostat off, press the  Power button in the middle of the control bar to the right of the display and touch OFF). Heating and cooling systems must be configured separately.

### SET-UP for NORMAL systems (not a heat pump):

1. Press the purple **MENU** button on the control bar and then touch **HVAC SET-UP**.
2. Touch to highlight **HEAT** in the upper left corner of the display.
3. Touch to highlight **NORMAL**.
4. Select the appropriate number of stages for your heating system (from 1 to 3) by touching the number of STAGES (in brackets) to highlight, and using the +/- buttons to increase or decrease.
5. Touch the appropriate **FAN CONTROL** setting.  
Select **HVAC** if your heating system controls the fan (appropriate for most gas, oil, propane and similar furnaces).  
Select **TSTAT** if you want the thermostat to control the fan (for most electric heating systems).
6. Go on to configure **COOL** or press **HOME** to return to the Home screen.

### SET-UP for NORMAL A/C cooling systems:

1. Press **MENU** and then touch **HVAC SET-UP**.
2. Touch and highlight **COOL** in the upper left corner of the display.
3. Select the number of stages of compression for your cooling system (1 or 2) by touching the number of **STAGES** and using +/- buttons to increase or decrease.
4. Touch to select the appropriate **FAN CONTROL** setting **HVAC** or **TSTAT**.

NOTE: Most cooling systems require that the thermostat **TSTAT** control the fan.

5. Press **HOME** to return to the Home screen.

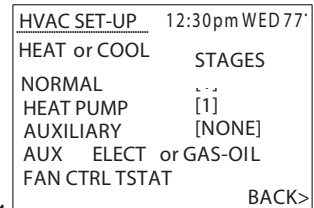

### SET-UP for HEAT PUMP systems:

1. Press **MENU** and then touch **HVAC SET-UP**.
2. Touch **HEAT** in the upper left corner of the display.
3. Touch **HEAT PUMP**.
4. Select the number of stages of compression for your heat pump system (1 or 2) by touching the number of STAGES, and using the +/- buttons to increase or decrease.

NOTE: Most heat pump systems have one stage of compression.

5. If you have AUXILIARY heat, touch the number of stages (default is [NONE] ) use the +/- buttons to select 1-2 stages. (NOTE: The LS-90 controls a maximum of 3 stages total between pump and AUX.)

6. (If you have AUX) Select the type of auxiliary heat that you have - Electric or Gas-Oil.

NOTE: Most heat pump systems have electric heat strips for auxiliary heat.

7. Fan Control is set by the LS-90 (tstat) for heat pumps.

8. Press HOME button to return to the Home screen.

NOTE: For heat pump system your cooling is already configured since the heat pump unit provides both heating and cooling.



### Check HVAC system

Follow these procedures to verify you have correctly installed the LS-90.



To check Fan (If you connected the G wire - fan relay):

1. Touch the FAN icon on the **HOME** screen and select **ON**.
2. Verify that air is blowing from the system. Return fan to **AUTO** selection for normal operation. Press **HOME**.

To check HEAT mode:

1. Press the mode control  and select HEAT.
2. Press the **+** button to raise the target temp to 90°F. Allow the system 2 minutes to respond
3. Verify that heat is blowing from the system.
4. Return mode control  to OFF (leave OFF for 4 minutes before checking COOL)

To check COOL mode (do not operate AC if outside temp is below 65°F):

1. Press the  mode control and select **COOL**.
2. Press the blue **-** button to lower the cool target temperature to 50°F. Allow the system 5 minutes to respond.
3. Verify that cool air is blowing from the system.
4. Return  mode to OFF

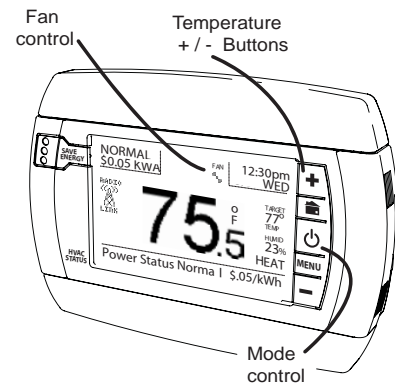

**Congratulations, you have successfully installed your unit. Please proceed to the OPERATING Guide to initialize the LS-90.**

**▲ IMPORTANT:** After you have labeled and connected your wires, and followed the correct HVAC set-up, if these check procedures do not operate your system call support at 1-877-602-5028 8am-12am EST.

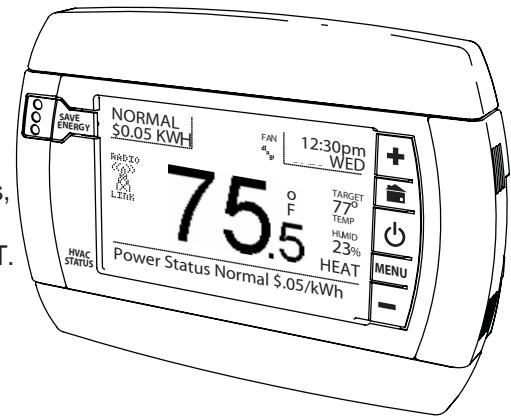

## LS-90 Features

This thermostat can be used with all 24VAC and millivolt (24VAC external power) heating and cooling systems. It cannot be used with line voltage systems. This thermostat is digital and your desired heat or cool temperatures can easily be set on the large touch screen with the +/- buttons. A minimum 4 minute off time protects heating and cooling compressors from damage. This thermostat uses a new technique called sequential staging for more comfort with faster reaction to requested temperature changes.

### 24VAC is Required -

This thermostat must be run on the HVAC systems 24VAC (C wire) or external 24VAC transformer connected to the C and RH terminals. The 24VAC "C" wire is the other side of the 24VAC heating transformer and can be found where the other thermostat wires connect at the wall or at the furnace. Do not use the common or ground side of the line voltage.

### Calibration -

Your thermostat was accurately calibrated at the factory to  $\pm 1^\circ$  F of actual ambient temperature. You do have the option, however, to change the display temperature to match that of a previous thermostat, or to match another thermostat already in your home, from  $\pm 1 - 9^\circ$ F.

#### To change your Thermostat Calibration:

1. Press **MENU** and then touch **CALIBRATE**
2. Use the + / - buttons to adjust the displayed temperature up or down, as desired.
3. The DELTA FACTOR that appears on the screen will also automatically increase or decrease for each  $1^\circ$  adjustment. The large display will show the modified temperature reading that will be displayed on the HOME screen in normal operation.
4. Press **HOME** to return to the Home screen .

**LCD Screen CONTRAST** can be adjusted.

#### To change LCD Screen CONTRAST

From the CALIBRATE screen:

1. Select **CONTRAST** and adjust by touching the on-screen < and > controls for best viewing.
2. Press **HOME** to return to the Home screen.

Calibrate controls

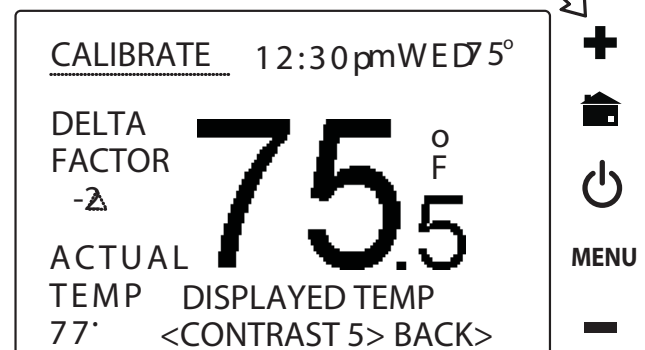

**Humidifier -**

To use the internal humidistat to control an external humidifier unit, connect it as shown. Connect the H terminal to the control leg of the humidifier relay. This allows H to turn the humidifier ON and Off.

**De-Humidifier -**

To use the internal humidistat to control an external De-humidifier unit, connect it as shown. Connect the DH terminal to the control leg of the dehumidifier relay. This allows DH to turn the dehumidifier ON and Off.

**Fresh Air -**

The Fresh Air feature uses the EX relay to control a baffle on a fresh external air source. Connect the 24VAC baffle to C and EX terminals.

**FOR FRESH AIR BAFFLE**

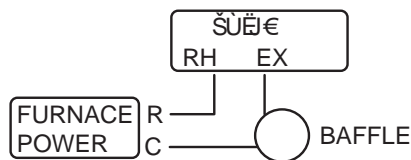

**FOR EXTERNAL HUMIDIFIER or DEHUMIDIFIER USING HVAC SYSTEM'S 24VAC**

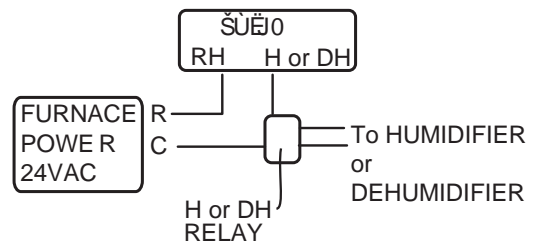

**FOR EXTERNAL HUMIDIFIER or DEHUMIDIFIER USING 24VAC ADAPTER**

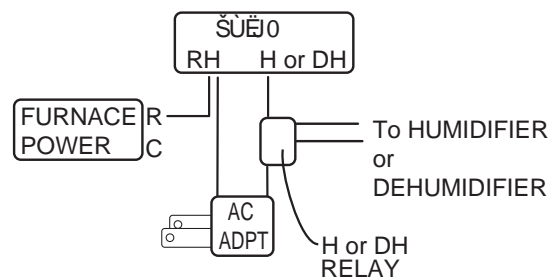

**WIRE REFERENCE CHART**

*Your Wires*

- R or V or VR
- RH or 4
- RC
- W
- W2
- W3
- ?
- Y
- Y2
- G or F
- C or X
- E
- L
- T
- H
- DH
- EX
- B or
- O
- B and O

*LS-90 Terminal*

- RH and RC Single power for HEAT and COOL
- RH Power for HEAT (RH not connected to RC jumper clip removed)
- RC Power for COOL (RH not connected to RC jumper clip removed)
- W Heat control
- W2 2nd stage HEAT or heat pump auxiliary heat
- W3 3rd stage HEAT or 2nd stage of 2 stage auxiliary heat
- A 3rd wire for zoned hot water heat (see zoned systems pg14)
- Y COOL control or 1st stage compression for heat pump.
- Y2 2nd stage COOL control or 2nd stage compression for a heat pump
- G FAN control
- C Common 24VAC power (to power thermostat) NOTE: TRANE uses B for this connection
- n/a Emergency heat (do not connect, tape off)
- n/a System monitor (do not connect, tape off)
- n/a Outdoor sensor (do not connect, tape off)
- External Humidifier
- External De-Humidifier
- External fresh air baffle
- B Heat pump changeover (cool to heat, powered in heat)
- O Heat pump changeover (heat to cool, powered in cool)
- ⚠ IMPORTANT: If there are both B and O wires (Trane pump products) DO NOT CONNECT B to B terminal, connect B to C terminal. If not a Trane product tape off B.**

**Lennox Heat Pump**

- V or VR or R
- M or Y
- Y or W or W2
- F or G
- R or O

- RH Power for HEAT
- Y
- W2
- G
- OX or X2 or C
- C

**Trane Products [American Standard]**

- B
- W or W1 or X2
- C
- W2

### Zoned Systems Reference

**Your Wires                      Radio Thermostat Terminal**

**2 wire Zoned Hot Water**

R	RH
W	W

**3 Wire Zoned Hot Water**

**Motor Driven Valves**

R or 5	RH (power)
W or 4	W (heat ON)
Y or G or 6 (the 3rd wire)	A (heat OFF)

**3 Wire Zoned Hot Water**

**Solenoid Valves**

R	RH (power)
W	A (heat ON)
Y or G (the 3rd wire)	W (heat OFF)

**Notes on your system**

---

---

---

---

---

Customer support: 877-602-5028 or [www.radiothermostat.com](http://www.radiothermostat.com)