



**LG Customer Information Center**

For inquires or comments, visit [www.lge.com](http://www.lge.com) or call;

**1-800-243-0000** USA, Consumer User

**1-888-865-3026** USA, Commercial User

**1-888-542-2623** CANADA

**Register your product Online!**

[www.lge.com](http://www.lge.com)



**LG**

Life's Good

ENGLISH

FRANÇAIS

ESPAÑOL

# OWNER'S MANUAL REFRIGERATOR FREEZER

Please read this manual carefully before operating your set and retain it for future reference.

# TABLE OF CONTENTS

<b>REFRIGERATOR SAFETY</b> .....	3
<b>INSTALLING YOUR REFRIGERATOR</b> .....	4
Unpacking Your Refrigerator.....	4
Installation .....	4
Electrical Requirements .....	5
Registration .....	5
<b>FEATURES CHART</b> .....	6
<b>OPERATION</b> .....	7
Connection .....	7
Control Panel .....	8
Temperature Control .....	8
Quick Freezer .....	8
ECO Model .....	9
Loose-Fitting Door Alarm .....	9
Self Test .....	10
Removal And Installation Of Detachable Glass Shelf .....	10
Removal And Installation Of Drawer In Refrigeration Compartment.....	10
Removal And Installation Of Drawer In Freezing Compartment.....	11
Ice Preparation.....	11
<b>CARE AND MAINTENANCE</b> .....	12
Foodstuff Storage .....	12
During Move .....	13
Refrigeration Operation Features .....	13
Anti-Condensation Tube .....	13
<b>CLEANING YOUR REFRIGERATOR</b> .....	14
<b>REPLACEMENT OF DOOR OPENING TYPE</b> .....	15
<b>BEFORE CALLING FOR SERVICE</b> .....	17
<b>TROUBLESHOOTING</b> .....	18
<b>SMART DIAGNOSIS(Option)</b> .....	20

# REFRIGERATOR SAFETY

## Your safety and the safety of others is very important.

We have provided many important safety messages in this manual and on your appliance. Always read and obey all safety messages.



This is the safety alert symbol.

This symbol alerts you to hazards that can kill or hurt you and others.

All safety messages will be preceded by the safety alert symbol and the word **DANGER** or **WARNING**. These words mean:

**⚠ DANGER**

You will be killed or seriously injured if you don't follow instructions.

**⚠ WARNING**

You can be killed or seriously injured if you don't follow instructions.

**⚠ CAUTION**

Indicates an imminently hazardous situation which, if not avoided, may result in minor or moderate injury, or product damage only.

All safety messages will identify the hazard, tell you how to reduce the chance of injury, and tell you what can happen if the instructions are not followed.

ENGLISH

## IMPORTANT SAFETY INSTRUCTIONS

**WARNING:** To reduce the risk of fire, electric shock, or injury when using your refrigerator, follow these basic precautions:

- Plug into a grounded 3-prong outlet.
- Do not remove ground prong.
- Do not use an adapter.
- Do not use an extension cord.
- Disconnect power before servicing.
- Replace all panels before operating.
- Remove doors from your old refrigerator.
- Use nonflammable cleaner.
- Keep flammable materials and vapors, such as gasoline, away from refrigerator.
- Use two or more people to move refrigerator using handles and install refrigerator.
- Disconnect power before installing ice maker.  
(on some models)

## SAVE THESE INSTRUCTIONS

### Proper Disposal of Your Old Refrigerator

**⚠ DANGER**

#### Suffocation Hazard

**Remove doors from your old refrigerator.**

Failure to do so can result in death or brain damage.

### Before you throw away your old refrigerator or freezer:

- Take off the doors.
- Leave the shelves in place so that children may not easily climb inside.

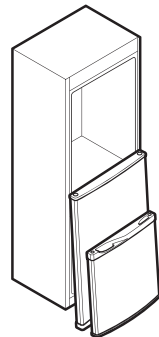

**IMPORTANT** - Child entrapment and suffocation are not problems of the past. Junked or abandoned refrigerators are still dangerous - even if they will sit for just a few days. If you are getting rid of your old refrigerator, please follow these instructions to help prevent accidents.

# INSTALLING YOUR REFRIGERATOR

## **⚠ WARNING**

### **Excessive Weight Hazard**

**Use two or more people to move and install refrigerator.**

Failure to do so can result in back or other injury.

## Unpacking Your Refrigerator

Remove tape and any temporary labels from your refrigerator before using. Do not remove any warning type labels, the model and serial number label, or the Tech Sheet that is attached to back wall of the refrigerator.

To remove any remaining tape or glue, rub the area briskly with your thumb. Tape or glue residue can also be easily removed by rubbing a small amount of liquid dish soap over the adhesive with your fingers. Wipe with warm water and dry.

Do not use sharp instruments, rubbing alcohol, flammable fluids, or abrasive cleaners to remove tape or glue. These products can damage the surface of your refrigerator. For more information, see **Important Safety Instructions** in the **Refrigerator Safety** section.

Refrigerator shelves are installed in the shipping position.

Please reinstall shelves according to your individual storage needs.

### **When Moving Your Refrigerator:**

Your refrigerator is heavy. When moving the refrigerator for cleaning or service, be sure to protect the floor.

Always pull the refrigerator straight out when moving it.

Do not wiggle or walk the refrigerator when trying to move it, as floor damage could occur.

**WARNING :** This product contains chemicals known to the State of California to cause cancer and birth defects or other reproductive harm.

**Wash hands after handling.**

## **⚠ WARNING**

This product contains chemicals known to the State of California to cause cancer and birth defects or other reproductive harm. **Wash hands after handling.**

## **⚠ WARNING**





### **Explosion Hazard**

**Keep flammable materials and vapors, such as gasoline, away from refrigerator.**

Failure to do so can result in death, explosion, or fire.

## Installation

1. Avoid placing the unit near heat sources, direct sunlight, or moisture.
2. To avoid vibration, the unit must be leveled. If required, adjust the leveling screws to compensate for uneven floor. The front should be slightly higher than the rear to aid in door closing. Leveling screws can be turned easily by tipping the cabinet slightly. Turn the leveling screws clockwise (  ) to raise the unit, counterclockwise (  ) to lower it.
3. Install this appliance between 55 °F (13 °C) and 110 °F (43 °C). If the temperature around the appliance is too low or high, cooling ability may lessen.

## NEXT

1. Clean your refrigerator thoroughly and wipe off all dust accumulated during shipping.
2. Install accessories such as ice cube bin, drawers, shelves, etc., in their proper places. They are packed together to prevent possible damage during shipment.
3. Let your refrigerator run for 2 or 3 hours before putting food in it. Check the flow of cold air in the freezer compartment to ensure proper cooling. Your refrigerator is now ready for use.

# INSTALLING YOUR REFRIGERATOR

## Electrical Requirements

### **⚠ WARNING**



#### **Electrical Shock Hazard**

**Plug into a grounded 3-prong outlet.**

**Do not remove ground prong.**

**Do not use an adapter.**

**Do not use an extension cord.**

Failure to follow these instructions can result in death, fire, or electrical shock.

Before you move your refrigerator into its final location, it is important to make sure you have the proper electrical connection:

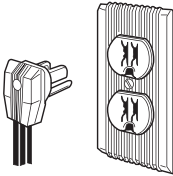

### **Recommended Grounding Method**

A 115 Volt, 60 Hz., AC only 15 or 20 ampere fused, grounded electrical supply is required. It is recommended that a separate circuit serving only your refrigerator be provided. Use an outlet that cannot be turned off by a switch. Do not use an extension cord.

**NOTE:** Before performing any type of installation, cleaning, or removing a light bulb, turn the control, (Thermostat, Refrigerator, or Freezer Control depending on the model) to OFF and then disconnect the refrigerator from the electrical source. When you are finished, reconnect the refrigerator to the electrical source and reset the control (Thermostat, Refrigerator, or Freezer Control, depending on the model) to the desired setting.

### **Supply Cord Replacement**

If the supply cord is damaged, it must be replaced by the manufacturer or its service agent or a similarly qualified person in order to avoid a hazard.

## Registration

The model and serial number are found on the rear of this unit. This number is unique to this unit and not available to others. You should record requested information here and retain this guide as a permanent record of your purchase. **Staple your receipt here.**

**Date of Purchase** : \_\_\_\_\_

**Dealer Purchased From** : \_\_\_\_\_

**Dealer Address** : \_\_\_\_\_

**Dealer Phone No.** : \_\_\_\_\_

**Model No.** : \_\_\_\_\_

**Serial No.** : \_\_\_\_\_

### **⚠ CAUTION**

This appliance is not intended for use by persons (including children) with reduced physical, sensory or mental capabilities, or lack of experience and knowledge, unless they have been given supervision or instruction concerning use of the appliance by a person responsible for their safety. Children should be supervised to ensure that they do not play with the appliance.

ENGLISH

# FEATURES CHART

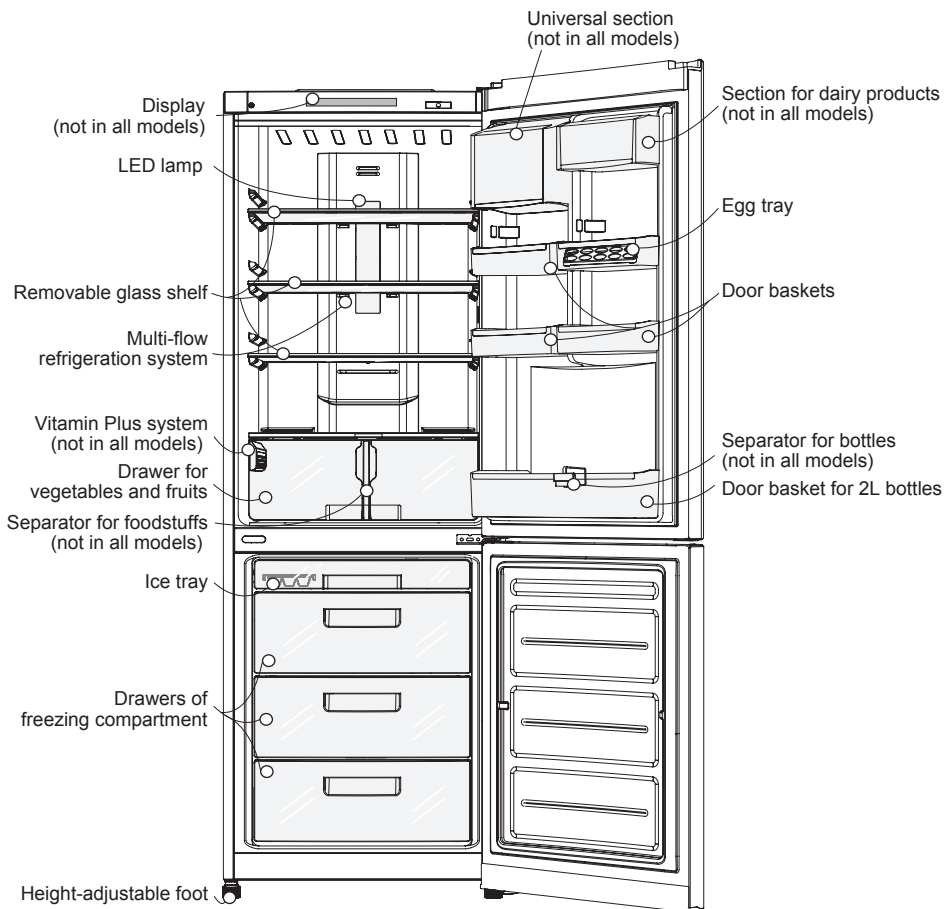

## Note

If you find some parts missing from your unit, they may be parts only used in other models.

# OPERATION

## CONNECTION

- Install the limit stops to the upper corners on the rear wall of the refrigerator as shown in Fig.1. The stops are supplied in the door basket inside the refrigeration compartment;
- Choose the suitable place. Locate the refrigerator in a place convenient for its use;
- The refrigerator is not a built-in appliance. Free space not less than 5 cm should be provided from above, from its rear and side faces for air circulation and reduction of power consumption. Fig.2;
- Do not install the refrigerator near heat sources and in a zone exposed to direct sunlight or high humidity;
- Make sure that electrical voltage indicated in the manual meets the parameters of your mains;
- Do not remove the round stickers on the rear side of the refrigerator. They have a decorative function closing the fabrication holes;
- To exclude vibration, check the refrigerator installation using a level. If necessary, turn the adjustable feet to compensate irregularity of the floor.  
To ensure better closing of the door, the refrigerator should be slightly inclined backwards. To turn the adjustable feet, slightly incline the refrigerator.
- Before use, carefully wash the refrigerator;
- Install the removable parts, such as ice tray, etc. to the appropriate places.  
It is necessary to prevent possible damages during transportation;
- Insert the power cord plug to the power outlet. Do not power other electric appliance from the same outlet.

After first installation of the refrigerator, let it work for 2-3 hours for stabilization of the operating temperature inside and only then fill the refrigerator with fresh or frozen foodstuffs. After disconnection of the refrigerator from the mains, wait at least 5 minutes to switch on it again. Now, the refrigerator is ready for service.

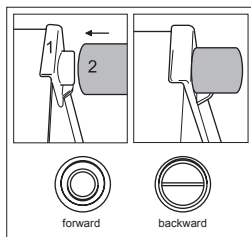

Figure 1. Installation of limit stops

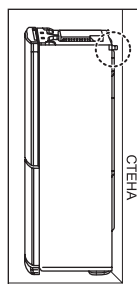

Figure 2. Installation of refrigerator to wall

## NOTE

The limit stops are located in the door basket of the refrigeration compartment. They should be installed to get higher operational efficiency of the refrigerator.



# OPERATION

## CONTROL PANEL

### External light-emitting-diode (LED) display



### Internal display

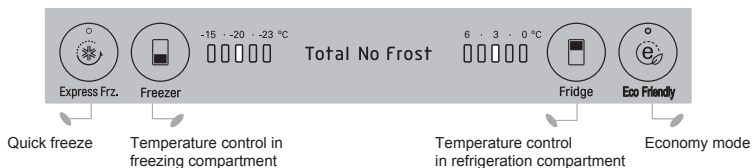

## TEMPERATURE CONTROL

The initial temperature in the refrigeration and freezing compartments is 3 °C and -20 °C, respectively.

If you wish, you can change it pushing the temperature control button of the appropriate compartment.

### External LED display



### Internal LED display

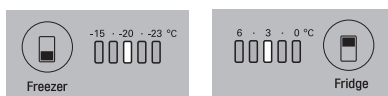

**NOTE** The actual inner temperature varies depending on the food status, as the indicated setting temperature is a target temperature, not actual temperature within refrigerator.

Refrigeration function is weak in the initial time.

Please adjust temperature as above after using refrigerator for minimum 2~3 days.

## QUICK FREEZE

It is used, if it is necessary to quickly freeze foodstuffs. Push once the "Quick freeze/Economy mode" button (on the external display) or "Quick freeze" button (on the internal display).

The "QUICK FREEZE" lamp will light up and quick freezing will be started. Quick freeze takes about 24 hours.

# OPERATION

Upon completion of this operation, the state (earlier set temperature mode).  
If you wish to stop the quick freeze operation, push again twice the "Quick freeze/Economy mode" button (on the external display) or once the "Quick freeze" button (on the internal display). The lamp will extinguish, the quick freeze operation will be stopped, and the refrigerator will return to the previous state (previous temperature mode).

External LED display

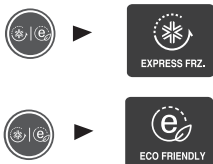

Internal LED display



## ECO MODE

It activates the power saving mode, which is convenient in the event of your long departure. It allows you to reduce power consumption. Push twice the "Quick freeze/Economy mode" button (on the external display) or once the "Economy mode" button (on the internal display). The lamp will light up (ECO MODE). Repeated pushing of the button deactivates this function.

External LED display



Internal LED display



To activate the "ECO MODE", push the "Quick freeze/Economy mode" button. Third pushing of the button deactivates both modes and the refrigerator returns to the previous temperature mode.

**NOTE** When the "ECO MODE" is activated, other buttons are inoperative. Push the "ECO MODE" button to return the appliance to the previous temperature mode. For power saving, the external display is switched to the energy conservation mode – backlighting of all indicators except for "LOCK" extinguishes.

## LOOSE-FITTING DOOR ALARM

- If the refrigerator door is opened for some time (30 sec), the alarm is activated;
- You can enable and disable the loose-fitting door alarm shortly pushing the "ALARM" button (not in all models);
- If the alarm continues to sound even after closure of the door, contact the service center.

External LED display



## "LOCK" (for models with LED display)

- When the "LOCK" button is activated, other buttons are inoperative;
- To lock/unlock the refrigerator display, push the "LOCK" button and hold it for 3 seconds.



**NOTE** In the event of power cutoff, the mode settings are kept.

# OPERATION

## SELF-TEST

The display has a self-test function. If the refrigerator has a failure, the buttons become inoperative and the indicator shows the error code. In this case, do not switch off power and immediately contact the local service center.

If you switch off the refrigerator, a service engineer may need much time to find the faulty element.

## REMOVAL AND INSTALLATION OF DETACHABLE GLASS SHELF

To remove a shelf from the refrigerator, first slightly raise it (1) and then pull (2). Improper removal may result in damage of internal parts in the refrigerator.

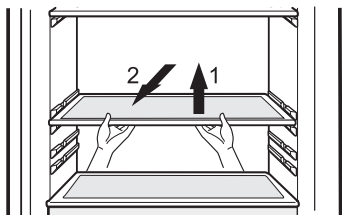

To install a shelf to the refrigerator, proceed in the same way: first raise the front edge of the shelf (3) and then push it to the refrigerator (4). Improper installation may result in damage of internal parts in the refrigerator.

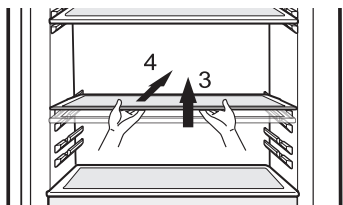

## REMOVAL AND INSTALLATION OF DRAWER IN REFRIGERATION COMPARTMENT

To remove the lower drawer from the refrigeration compartment, proceed as follows:

- Remove the lower basket from the door raising the basket;
- Pull the drawer all the way out raising it by the front part and pulling;

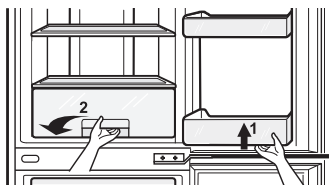

- Raise the drawer cover by the front part and pull to remove it;

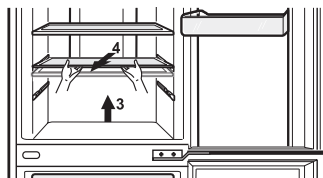

- To install the drawer back, proceed in the reverse sequence.

## ⚠ CAUTION

At that, you should take care to exclude slant. Improper removal and installation may result in damage of internal parts in the refrigerator.

**Two stars section (\*\*)** (Applicable to some models only)

- Two stars section means the space stored at -12°C~-18°C
- Freezer foods for short-terms storage.

# OPERATION

## NOTE

The guarantee does not cover mechanical damages (cracks, shears, dents, traces of enclosure opening, etc.) caused by violation of the refrigerator storage, transportation, operation, and maintenance rules, application of excessive force.

## REMOVAL AND INSTALLATION OF DRAWERS IN FREEZING COMPARTMENT

When a large quantity of foodstuffs is stored in the freezing compartment, you can remove the middle drawer from the appliance and store foodstuffs immediately on foodstuffs placed to the lower drawer.

To remove any drawer of the freezing compartment, proceed as follows:

1. Pull the drawer all the way out;
2. Raise it by the front part and pull.

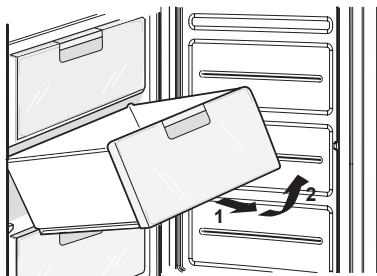

To install any drawer back to the freezing compartment, proceed in the reverse sequence:

1. Place the drawer onto the guides at an angle 45°;
2. Lower the front part of the drawer in parallel to the guides;
3. Push the drawer all the way in.

At that, you should take care to exclude slant.

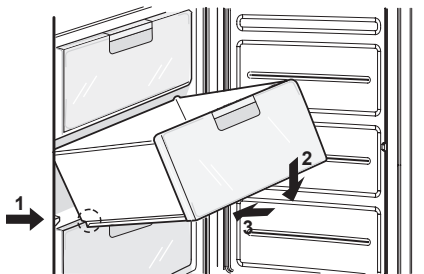

## ⚠ CAUTION

Do not apply excessive force to remove the drawers and shelves – this may result in damage of the refrigerator.

## ICE PREPARATION

Fill the ice tray with water and place it to the freezing compartment.



If ice cubes are required as soon as possible, activate the "QUICK FREEZE" function.

To remove ice cubes, hold the tray on ends and slightly bend it.



## ⚠ CAUTION!

Connect to potable water supply only.

## ADVICE

To easily remove cubes, water the tray in advance.

# CARE AND MAINTENANCE

## FOODSTUFF STORAGE

- Do not store food which goes bad easily at low temperature, such as banana, and melon.
- Allow hot food to cool prior to storing. Placing hot food in the fridge-freezer could spoil other food, and lead to higher electric bills.
- When storing the food, use a container with a lid. This prevents moisture from evaporating, and helps food to keep its taste and nutrients.
- Do not block air vents with food. Smooth circulation of cold air keeps fridge-freezer temperature even.
- Do not open the door frequently. Opening the door lets warm air enter the fridge-freezer, and cause temperature to rise.
- To adjust the temperature control easily, do not store food near the temperature control dial.
- Never keep too many foods in door rack, as this may stop the door from fully closing.
- Do not store bottles in the freezer compartment - they may break when frozen.
- Do not refreeze food that has been thawed. This causes loss of taste and nutrition.
- If it is necessary to quickly freeze fresh foodstuffs, place them to the lower drawer of the freezing compartment and push the "QUICK FREEZE" button;
- Frozen foodstuffs should be stored packed (in polyethylene film, aluminum foil, etc.) in the freezing compartment;
- Volume of the upper drawer in the freezing compartment is the "two stars" section. Temperature inside this section does not rise above -12°C. This should be taken into account for storage of foodstuffs.

## CLEANING

1. Before cleaning, make sure that power supply is switched off;
2. Outside and inside, the refrigerator should be washed with a clean napkin wetted in warm water with a liquid detergent. Then wipe dry with a dry napkin;
3. After cleaning, make sure that the power cord is not damaged. Then tightly insert the plug to the power outlet.

### **CAUTION**

1. It is prohibited to use abrasive materials, gasoline, benzene, solvents, hydrochloride, hot water, hard brushes, etc., which may damage the refrigerator surface.
2. For products with a stainless steel exterior, use a clean sponge or soft cloth and a mild Detergent in warm water. Do not use abrasive or harsh cleaners. Dry thoroughly with a Soft cloth. Do not use appliance wax, bleach, or other products containing chlorine on stainless steel.

### **VITAMIN PLUS (OPTIONAL)**

It contains anti-oxidant that is able to avoid oxidation process in order to make the fruits and vegetables fresh for longer time.

This part contains anti-oxidant substance that should not be eaten. Opening and closing the door too much often can reduce its lifetime.

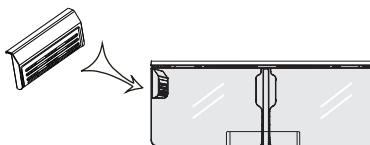

# CARE AND MAINTENANCE

## GENERAL

Electric power failure.

- An interruption in electric power supply for 1-2 hours will not harm the stored foodstuffs. Try to less frequently open and close the refrigerator door during this period.

### DURING MOVE:

- Remove all foodstuffs and other objects from the refrigerator. Firmly secure the internal detachable parts (shelves, drawers, door baskets);
- To avoid damage of the floor and adjustable feet of the refrigerator, turn them counter-clockwise before transportation;
- The refrigerator should be firmly secured in the truck to prevent its hits and falling inside the truck during transportation;
- The refrigerator should be transported in vertical position in a covered vehicle. The original package should not be damaged during transportation;
- During loading and unloading, the refrigerator should be protected against hits.

### BEFORE SWITCHING ON:

- If the refrigerator is transported in cold season, unpack the refrigerator in a warm room and do not switch on it for at least 12 hours.

### NOTE

If you keep the fridge-freezer in a hot, and humid place, frequently opening the door or putting a lot of vegetables in it may cause condensation to form.

This has no effect on its performance.

Remove the condensation with a dry, dust-free cloth.

If droplets form beneath the cover of the vegetable drawer, keep vegetables or fruits wrapped with plastic wrap.

## ⚠ CAUTION

Do not move or incline the refrigerator during its operation.

Noise may occur in the compressor.

This feature does not affect operability of the compressor.

## REFRIGERATOR OPERATION FEATURES

Cracking noise may be heard due to thermal deformations of the refrigerator components. Typical sounds from activation of the thermostatic controller and compressor are normal sounds occurring during operation of electric equipment in the appliance.

The refrigerant circulating inside the refrigeration system may calmly gurgle, even if the compressor is idle.

Do not worry, this is absolutely normal.

The following sounds may be heard during operation of the refrigerator:

- Clicks from actuation of the temperature sensor/switch;
- Murmur of the refrigerant circulating in tubes of the refrigeration system;
- Slight cracking noise from thermal deformations of materials.

These sounds are not associated with any defect and they have a functional aspect.

### ANTI-CONDENSATION TUBE:

- The anti-condensation tube is laid inside the enclosure around the front face of the refrigerator to exclude moisture condensation;
- The refrigerator may greatly heat up in these places, especially immediately after switching on for the first time or at high ambient temperature.

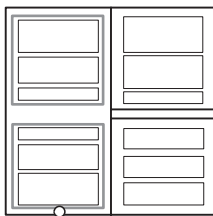

Anti-condensation tube

## ⚠ CAUTION

- Dry ice is very cold! Do not allow it to touch bare skin. It is well below °F and will cause immediate frostbite and damage to the skin and other tissue.
- Dry ice frozen carbon dioxide. Use only in a well ventilated area. As the ice releases carbon dioxide vapor, it could cause light-headedness, fainting, suffocation, or death.

# CLEANING YOUR REFRIGERATOR

## **WARNING**



### **Explosion Hazard**

#### **Use nonflammable cleaner.**

Failure to do so can result in death, explosion, or fire.

Both the refrigerator and freezer sections defrost automatically. However, clean both sections about once a month to prevent odors from building up. Wipe up spills immediately.

#### **To clean your refrigerator.**

- Unplug refrigerator or disconnect power.
- Remove all removable parts from inside, such as shelves, crispers, etc.
- Use a clean sponge or soft cloth and a mild detergent in warm water. Do not use abrasive or harsh cleaners.
- Hand wash, rinse, and dry all surfaces thoroughly.
- Plug in refrigerator or reconnect power.

- Additional cleaning tips are listed below:

<b>PART</b>	<b>COMMENTS</b>
<b>Outside</b>	<ul style="list-style-type: none"><li>■ Waxing external painted metal surfaces helps provide rust protection. Do not wax plastic parts. Wax painted metal surfaces at least twice a year using appliance wax (or auto paste wax). Apply wax with a clean, soft cloth.</li><li>■ For products with a stainless steel exterior, use a clean sponge or soft cloth and a mild detergent in warm water. Do not use abrasive or harsh cleaners. Dry thoroughly with a soft cloth.</li></ul>
<b>Inside walls (allow freezer to warm up so cloth won't stick)</b>	<ul style="list-style-type: none"><li>■ To help remove odors, you can wash the inside of the refrigerator with a mixture of baking soda and warm water. Mix 2 tablespoons soda to 1 quart of water (26 g soda to 1 liter water.) Be sure the soda is completely dissolved so it is not abrasive and doesn't scratch the surfaces of the refrigerator.</li></ul>
<b>Door liners and gaskets</b>	<ul style="list-style-type: none"><li>■ Do not use cleaning waxes, concentrated detergents, bleaches, or cleaners containing petroleum on plastic parts.</li></ul>
<b>Plastic parts (covers and panels)</b>	<ul style="list-style-type: none"><li>■ Do not use paper towels, window sprays, abrasive cleansers, or flammable fluids. These can scratch or damage material.</li></ul>
<b>Condenser coils</b>	<ul style="list-style-type: none"><li>■ Remove base grille. (See the Base grille section on page 6.)</li><li>■ Use a vacuum with an extended attachment to clean condenser coils.</li><li>■ Vacuum coils when dusty or dirty. Coils may need to be cleaned as often as every other month.</li><li>■ Replace base grille.</li></ul>

# REPLACEMENT OF DOOR OPENING TYPE

## REHINGING OF DOORS

The refrigerator is designed so that the doors can be opened right or left depending on the layout of your kitchen.

### ⚠ CAUTION!

1. Prior to hinging the door to the opposite side, first of all unload the refrigerator from foodstuffs and remove all unsecured accessories (shelves and drawers) from it.
2. To tighten and loose bolts, use a socket wrench or a box wrench for 10 mm.
3. Do not lay the refrigerator onto the floor.
4. Take care to exclude dropping of the door in the process of disassembly or assembly.

1. Unscrew the screw **2** of the upper hinge cover **1** to remove the hinge cover **1** and disconnect the connection cable **5** (only for models with an external display). Unscrew the bolts **3** fixing the upper hinge **4** and carefully remove the door from the middle hinge **18**. Remove the blank **8**.

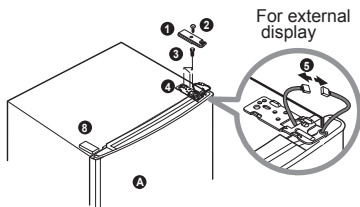

2. Remove the upper door cover **7** (only for models with an external display), pull out the cable **5** and install it to the hole on the opposite side of the door. Install the upper door cover **7** into place.

Remove the plastic bushing **6** from the door of the refrigeration compartment **A**. Unscrew the screw **10** located above the door of the refrigerator and move the door stop **9** to the opposite side. Tighten the screw **10**. Move the plastic bushings **6** and **14** (only for models with an internal display) to the opposite side.

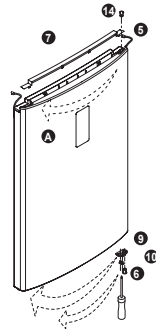

3. (Only for models with an external display). Using a flat screwdriver, push and separate the caps **12** from the front panel **11** and unscrew the screws **13**, remove the panel **11**, move the cable **15** to the opposite side. After installation of the panel **11** into place, tighten the screws **13** and close their heads with the caps **12**.

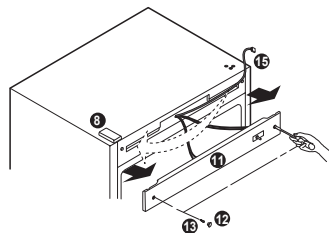

4. Unscrew the bolts **17** of the middle hinge, remove the middle hinge and raise the door of the freezing compartment **B** to remove the door. Remove the blank **19** and install it instead of the removed middle hinge **18**.



Unscrew the dowel 22 of the lower hinge 23 turning it counter-clockwise and screw the dowel into the opposite hole. Unscrew the bolts 24 fixing the lower hinge 23 and bolt 25 on the refrigerator enclosure. Unscrew the screw 10 on the lower part of the door fixing the door closer 29 of the freezing compartment B. Unscrew the screw 10 on the lower part of the door fixing the door stop 9 of the freezing compartment B, move the stop 9 to the opposite side into the dedicated place and fix it. Rehinge the closer 29 to the opposite side into the dedicated place and fix it. Move the upper cap 26 to the opposite side.

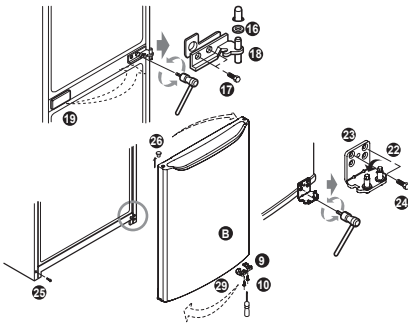

5. Attach the removed lower hinge 23 to the holes located on the opposite side of the enclosure and fix the hinge with the bolts 24. Tighten the screw 25 in the enclosure on the opposite side. Install the door of the freezing compartment B onto the lower hinge dowel 23. Unfold the removed middle hinge 18 with its axis out and fix the hinge with the bolts 17 (tighten the bolts carefully to exclude scratching of the door). Install the washer 16 onto the middle hinge 18.

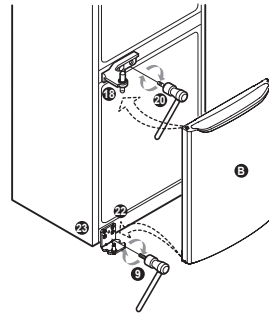

6. Install the door of the refrigeration compartment A aligning the hole in the lower part of the door and middle hinge dowel 18. Then install the upper hinge 27 supplied in the refrigerator package placing the dowel into the appropriate upper hole in the door of the refrigeration compartment A. Connect the cable connectors 5 (only for models with an external display). Fix the upper hinge 27 using the bolts 3. Install the left cover of the upper hinge 29 and fix it with the screw 2. Install the blank 28 supplied in the refrigerator package.

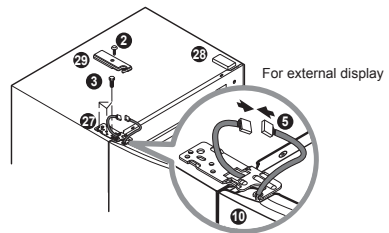

### After Completing the job

- Make sure that the four corners of the door gasket are not folded. It is recommended to apply a small amount of silicon grease on them.
- Adjust the leveling screw on the bottom to the highest level so that the front side of the refrigerator is higher than the rear side.
- If you need assistance after switching the direction of the door opening as shown above, call a service center.

### Note

Reversing the doors is not covered by the warranty.

# BEFORE CALLING FOR SERVICE

SERVICE CALLS CAN OFTEN BE AVOIDED!

IF YOU FEEL YOUR REFRIGERATOR IS NOT OPERATING PROPERLY, CHECK THESE POSSIBLE CAUSES FIRST:

PROBLEM	POSSIBLE CAUSES
REFRIGERATOR DOES NOT OPERATE	<ul style="list-style-type: none"><li>■ Has a house fuse blown or circuit breaker tripped?</li><li>■ Has the power cord plug been removed or loosened from the electrical wall outlet?</li></ul>
REFRIGERATOR OR FREEZER COMPARTMENT TEMPERATURE TOO WARM	<ul style="list-style-type: none"><li>■ Temperature control not set on proper position.</li><li>■ Appliance is placed close to wall or heat source.</li><li>■ Warm weather-frequent door openings.</li><li>■ Door is not closed entirely.</li><li>■ Door left open for a long time.</li><li>■ Large amount of foods are kept in the refrigerator.</li></ul>
ABNORMAL NOISE(S)	<ul style="list-style-type: none"><li>■ Refrigerator is installed in a weak or uneven place or leveling screw needs adjusting.</li><li>■ Unnecessary objects placed in the back side of the refrigerator.</li></ul>
REFRIGERATOR HAS ODOR	<ul style="list-style-type: none"><li>■ Foods with strong odors should be tightly covered or wrapped.</li><li>■ Interior needs cleaning.</li></ul>
DEW FORMS ON THE CABINET SURFACE	<ul style="list-style-type: none"><li>■ Not unusual during periods of high humidity.</li><li>■ Door may have been left ajar.</li></ul>

ENGLISH

## Customer Assistance Numbers:

- To Prove Warranty Coverage  
Retain your Sales Receipt to prove date of purchase.  
A copy of your Sales Receipt must be submitted at the time warranty service is provided.
- To Obtain Product, Customer or Service Assistance  
Call Toll-free for Customer Service  
Tel : 1-888-542-2623 (1-888-LG-CANADA)
- To Obtain Nearest Authorized Service Center  
Call 1-888-542-2623, push option #1, 24 hours a day, 7days per week.  
Please have your product type (Monitor, TV, VCR, MWO, Refrigerator) and ZIP code ready.

# TROUBLE SHOOTING

PROBLEM	POSSIBLE CAUSES
REFRIGERATOR-FREEZER DOES NOT OPERATE	<ul style="list-style-type: none"><li>■ <b>Power plug may be unplugged from the electric outlet.</b> Plug it in securely.</li><li>■ <b>House fuse has blown or circuit breaker has tripped.</b> Check and/or replace fuse and reset circuit breaker.</li><li>■ <b>Power cut.</b> Check house lights.</li></ul>
REFRIGERATOR OR FREEZER COMPARTMENT TEMPERATURE TOO WARM	<ul style="list-style-type: none"><li>■ <b>Temperature control not set on proper position.</b> Refer to Temperature Control section.</li><li>■ <b>Appliance is placed close to heat source.</b></li><li>■ <b>Warm weather-frequent door openings.</b></li><li>■ <b>Door left open for a long time.</b></li><li>■ <b>Package holding door open or blocking air duct in freezer compartment.</b></li></ul>
VIBRATION OR RATTLING OR ABNORMAL NOISE	<ul style="list-style-type: none"><li>■ <b>The floor on which the Refrigerator-Freezer is installed may be uneven or the Refrigerator-Freezer may be unstable.</b> Make it even by rotating the leveling screw.</li><li>■ <b>Unnecessary objects placed in the back side of the Refrigerator-Freezer.</b></li></ul>
FROST OR ICE CRYSTALS ON FROZEN FOOD	<ul style="list-style-type: none"><li>■ <b>Door may have been left ajar or package holding door open.</b></li><li>■ <b>Too frequent or too long door openings.</b></li><li>■ <b>Frost within package is normal.</b></li></ul>
MOISTURE FORMS ON CABINET SURFACE	<ul style="list-style-type: none"><li>■ <b>This phenomenon is likely to occur in a wet space.</b> Wipe it with a dry towel.</li></ul>
MOISTURE COLLECTS INSIDE	<ul style="list-style-type: none"><li>■ <b>Too frequent or too long door openings.</b></li><li>■ <b>In humid weather, air carries moisture into refrigerator when doors are opened.</b></li></ul>

# TROUBLE SHOOTING

PROBLEM	POSSIBLE CAUSES
REFRIGERATOR HAS ODOR	<ul style="list-style-type: none"><li>■ Foods with strong odors should be tightly covered or wrapped.</li><li>■ Check for spoiled food.</li><li>■ Interior needs cleaning. Refer to CLEANING section</li></ul>
DOOR NOT CLOSING PROPERLY	<ul style="list-style-type: none"><li>■ <b>Food package is keeping door open.</b> Move packages that keep door from closing.</li><li>■ <b>Refrigerator-Freezer is not level.</b> Adjust the leveling screws.</li><li>■ <b>The floor on which the Refrigerator-Freezer is installed may be uneven or the Refrigerator-Freezer may be unstable.</b> Slightly raise the front side with the leveling screw.</li></ul>
INTERIOR LIGHT DOES NOT WORK	<ul style="list-style-type: none"><li>■ <b>No power at outlet.</b></li><li>■ <b>Light lamp needs replacing.</b> Refer to the Lamp Replacement section</li></ul>

# SMART DIAGNOSIS(Option)

## SMART DIAGNOSIS

Should you experience any problems with your refrigerator, it has the capability of transmitting data via your telephone to the LG service center. This gives you the capability of speaking directly to our trained specialists. The specialist records the data transmitted from your machine and uses it to analyze the issue, providing a fast and effective diagnosis.

If you experience problems with your refrigerator, call the phone No. of LG Customer Information Center. Only use the Smart Diagnosis feature when instructed to do so by the LG call center agent. The transmission sounds that you will hear are normal and sound similar to a fax machine.

Smart Diagnosis cannot be activated unless your refrigerator is connected to power. If your refrigerator is unable to turn on, then troubleshooting must be done without using Smart Diagnosis.

## Using Smart Diagnosis

First, call the phone No. of LG Customer Information Center. Only use the Smart Diagnosis feature when instructed to do so by the LG call center agent.

### 1 Lock the display. (Option)

To lock the display, press and hold the Lock button for three seconds. (If the display has been locked for over five minutes, you must deactivate the lock and then reactivate it.)



### 2 Open the refrigerator door.

- 3 Hold the mouthpiece of your phone in front of the speaker that is located on the right hinge of the refrigerator door, when instructed to do so by the call center.

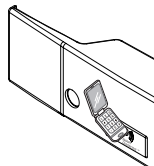

- 4 Press and hold the Freezer Temperature button for three seconds while continuing to hold your phone to the speaker.



- 5 After you hear three beeps, release the Freezer Temperature button.
- 6 Keep the phone in place until the tone transmission has finished. This takes about 15 seconds, and the display will count down the time. Once the countdown is over and the tones have stopped, resume your conversation with the specialist, who will then be able to assist you in using the information transmitted for analysis.

### ! NOTE

- For best results, do not move the phone while the tones are being transmitted.
- If the call center agent is not able to get an accurate recording of the data, you may be asked to try again.

### ! NOTE

- Call quality differences by region may affect the function.
- Use the home telephone for better communication performance, resulting in better service.
- Bad call quality may result in poor data transmission from your phone to the machine, which could cause Smart Diagnosis to not work properly.