



Dear Valued Customer,

Kraus would like to take this opportunity to thank you for purchasing Kraus products. It is our sincere hope that you are completely satisfied with your new purchase. We welcome any questions or comments you may have, and look forward to assisting you in the future.

Sincerely,
Kraus customer service department.



Soap Dispenser

Before Your Installation

Check to make sure you have the following parts indicated below:

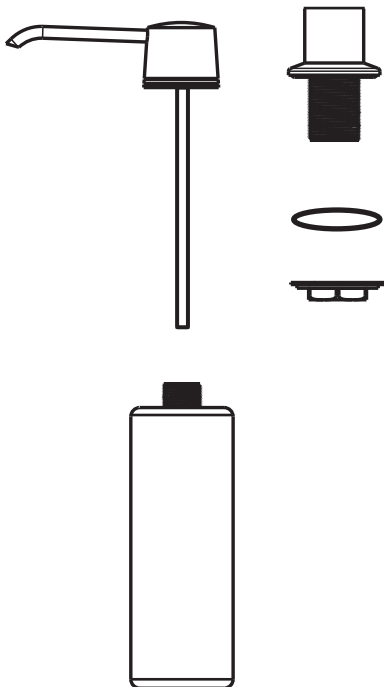

MODEL
SD-30-CH
SD-30-SN
SD-30-ORB

Tools You Will Need



Adjustable wrench

Soap Dispenser Installation Procedure

1

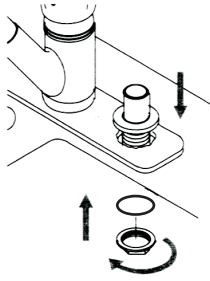

Attach nut and washer to container threads. Insert container through hole below sink. Position concealment flange and secure with dispenser base.

2

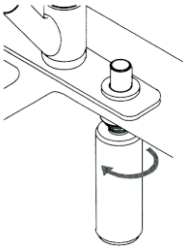

Tighten nut.

3

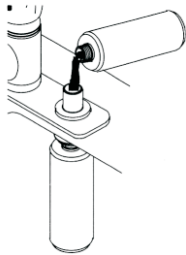

Fill container with approximately 8-10oz. of soap or lotion.

4

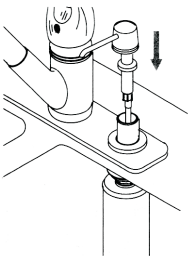

Insert pump.

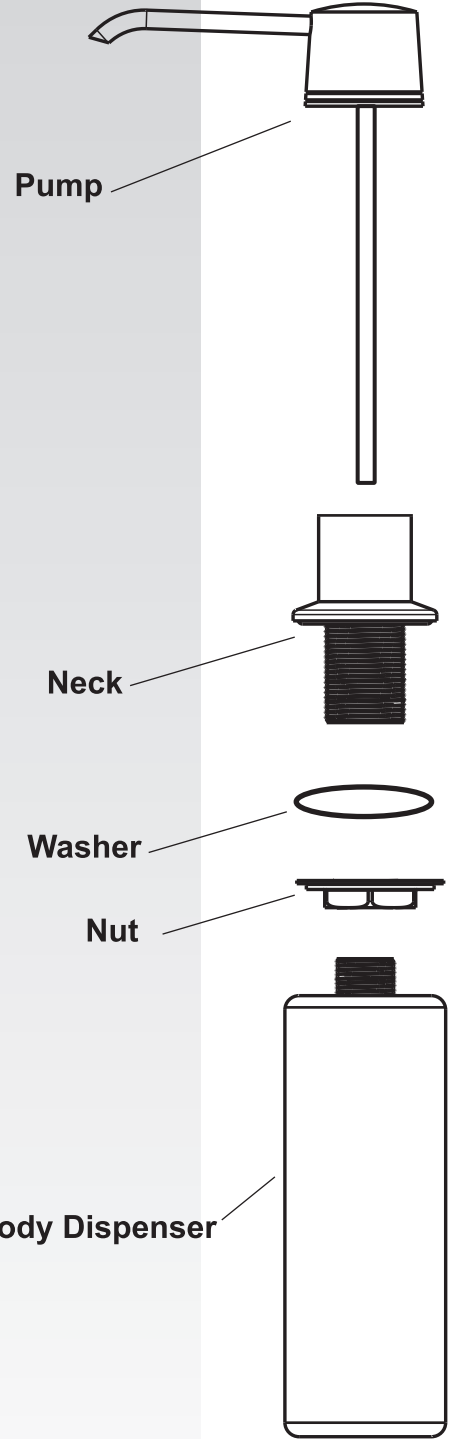

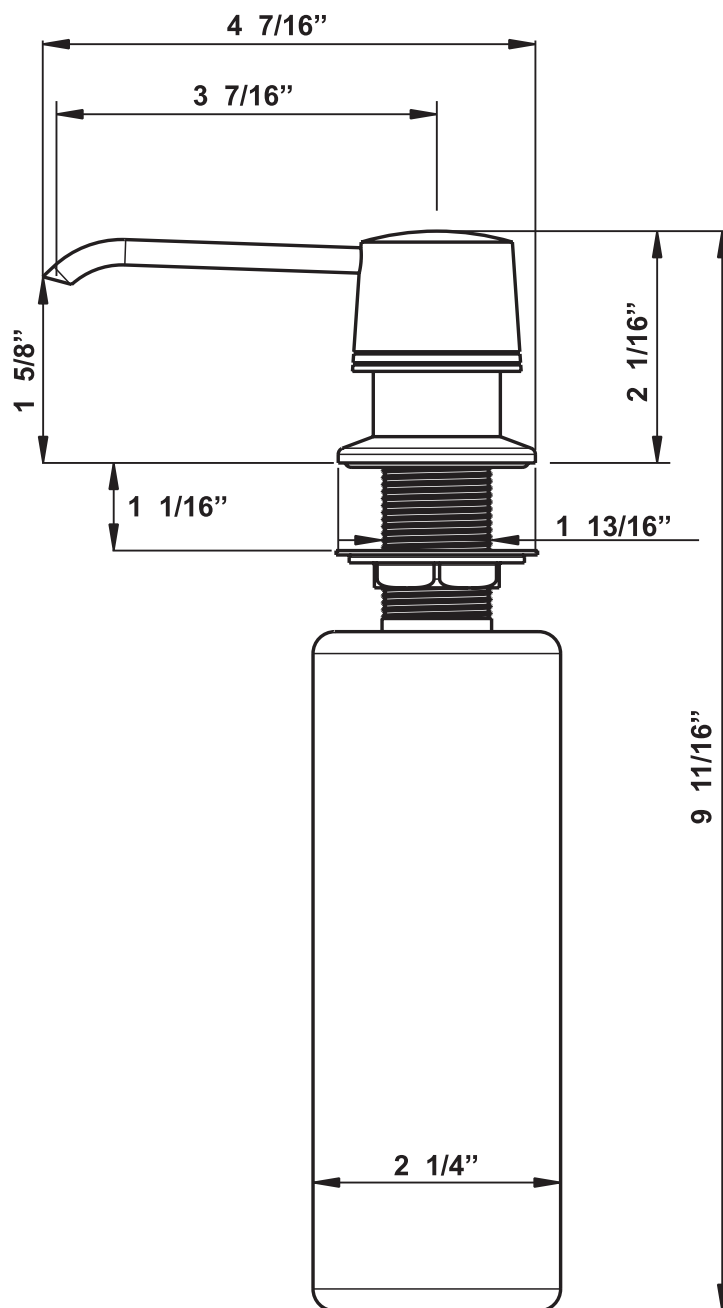

About Kraus

Kraus is a leading designer and manufacturer of a broad selection of unique bathroom fixtures and accessories, including vessel sinks, faucets, showers, vanities and bathroom accessories. Kraus incorporates its distinguished style with superior functionality and affordability, maintaining the highest standards of quality in its vast product line.

The Kraus brand name represents a fusion of leading-edge technology and an eye toward design. Our design team continuously explores broader markets, seeking new trends while maintaining superior quality at unprecedented prices. The Kraus collection has the widest selection of exquisite styles for any type of décor, from modern residences to countryside homes.

For Kraus, durability and reliability have always been vital components for achieving the highest standards. Every model we offer undergoes rigorous testing and inspection prior to distribution. The key element of our success is our customers' satisfaction. As a result, our products are in high demand with shoppers worldwide.