

KRAUS BRAND BATHROOM FAUCETS LIMITED LIFETIME WARRANTY

KRAUS is proud to offer its customers the strongest, most durable ceramic cartridges in all solid brass Bathroom Faucets it manufactures. KRAUS guarantees all products to be free of defect in materials and craftsmanship. All KRAUS BRAND Bathroom Faucets carry a limited lifetime warranty from the original date of purchase.

If a product fails due to defect in material or craftsmanship during the warranty period, KRAUS will repair or replace the items at its sole discretion. Warranty does not apply when the item has been tampered with, misused, improperly installed, altered, or damaged due to abuse or accident. Proof of purchase (original sales receipt) must be provided to KRAUS for all warranty claims. Please contact one of our representatives if you need any additional details.

All KRAUS products must be installed by a licensed professional plumber or contractor to avoid any improper use or installation.

IN NO EVENT SHALL KRAUS BE LIABLE FOR ANY INCIDENTAL, CONSEQUENTIAL OR SPECIAL DAMAGES, INSTALLATION COST, LABOR, TRAVEL TIME, FREIGHT COSTS INCURRED, LOST PROFITS, OR CONTINGENT LIABILITIES.

KRAUS USA Inc. makes no representation that its products comply with any or all local building or plumbing codes. It is the consumer's responsibility to determine local code compliance.

This warranty extends to the original purchaser and first consumer.

Contact Us Toll-Free at 1-800-775-0703; or visit our website at www.kraususa.com ©2008-2011 Kraus USA Inc.

Kräus®

Where Creativity Is Endless

Installation Manual

Bathroom faucet

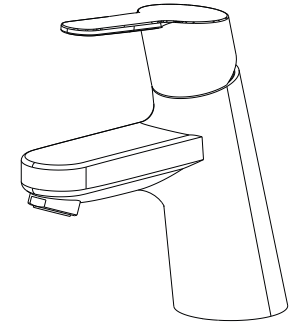

Dear Valued Customer,

Kraus would like to take this opportunity to thank you for purchasing Kraus products. It is our sincere hope that you are completely satisfied with your new purchase. We welcome any questions or comments you may have, and look forward to assisting you in the future.

Sincerely,
Kraus customer service department.

Before Your Installation

Check to make sure you have the following parts indicated below:

Model

KEF-14901

Tools You Will Need

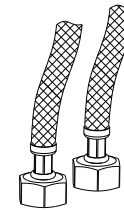
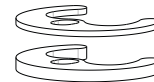

Adjustable wrench



Adjustable wrench

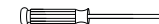

Phillips screwdriver



Pipe tape (supplied)



Spanner for body (supplied)

Contact Us Toll-Free at 1-800-775-0703; or visit our website at www.kraususa.com ©2008-2011 Kraus USA Inc.

Replacement Parts

Keep this manual for ordering replacement parts.

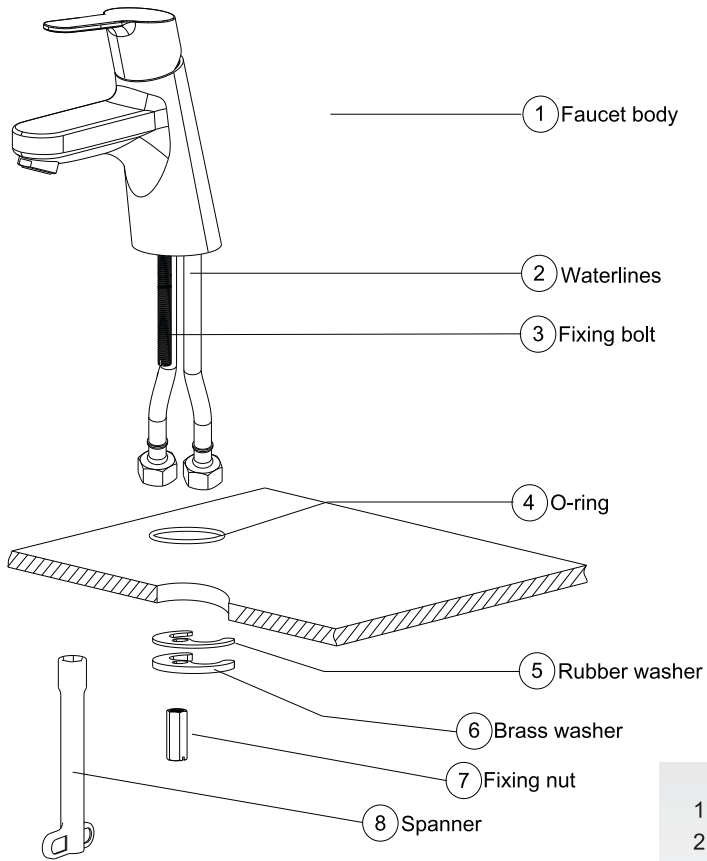

1. Faucet body
2. Waterlines
3. Fixing bolt
4. O-ring
5. Rubber washer
6. Brass washer
7. Fixing nut
8. Spanner

Trouble - Shooting

PROBLEM	CAUSE	ACTION
Leaks underneath handle	Adjusting ring or cap has come loose.	Tighten the adjusting ring or cap.
Aerator leaks or has an inconsistent water flow pattern.	Aerator is dirty or misfitted.	Unscrew the aerator to check rubber packing or replace the aerator.
Water will not shut off completely.	Dirty or worn out plastic washer in the cartridge.	Remove handle and cartridge to check if ceramic disk is damage permanently or dirty. Re-install cartridge.

Contact Us Toll-Free at 1-800-775-0703; or visit our website at www.kraususa.com ©2008-2011 Kraus USA Inc.

Installation

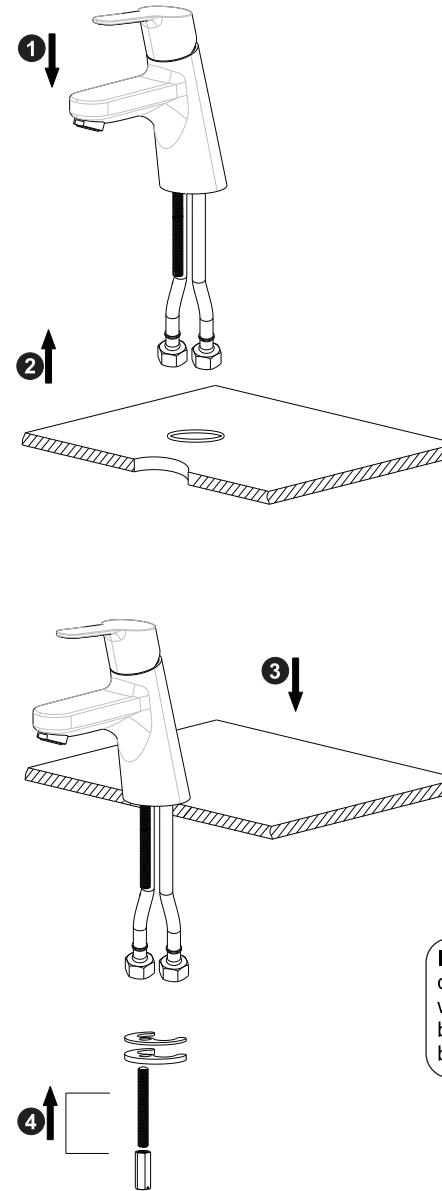

Screw waterlines 2 into the corresponding screw-hole of faucet body 1. Fit O-ring 4 into the bottom groove of faucet body 1. After, screw the fixing bolt 3 into the corresponding screw-hole of faucet body 1.

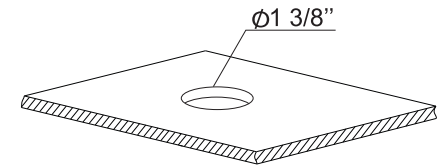

Insert waterlines 2 and fixing bolt 3 through the drilled hole 1 3/8" of the countertop. Put rubber washer 5 and brass washer 6 onto the fixing bolt, screwing on the nut 7. Then place faucet body 1 correctly and securely tighten nut 7.

Contact Us Toll-Free at 1-800-775-0703; or visit our website at www.kraususa.com ©2008-2011 Kraus USA Inc.