

### Features

- Coordinates with Jacquard vanities for a matched ensemble.
- Wood frame with catalyzed conversion varnish provides a durable moisture-resistant finish.
- Includes hardware for wall-mount installation.

### Material

- Glass
- Solid woods and veneers.



### Codes/Standards











EPA TSCA Title VI  
CARB P2

### KOHLER® One-Year Limited Warranty

See website for detailed warranty information.

### Available Color/Finishes

*Color tiles intended for reference only.*

Color	Code	Description
	1WA	Linen White
	1WF	Khaki White Oak
	1WD	Ramie Walnut
	1WG	Cherry Tweed
	1WB	Claret Suede
	1WH	Woolen Oak
	1WC	Felt Grey
	1WE	Terry Walnut
	1WT	Mohair Grey
	1WU	Batiste Black

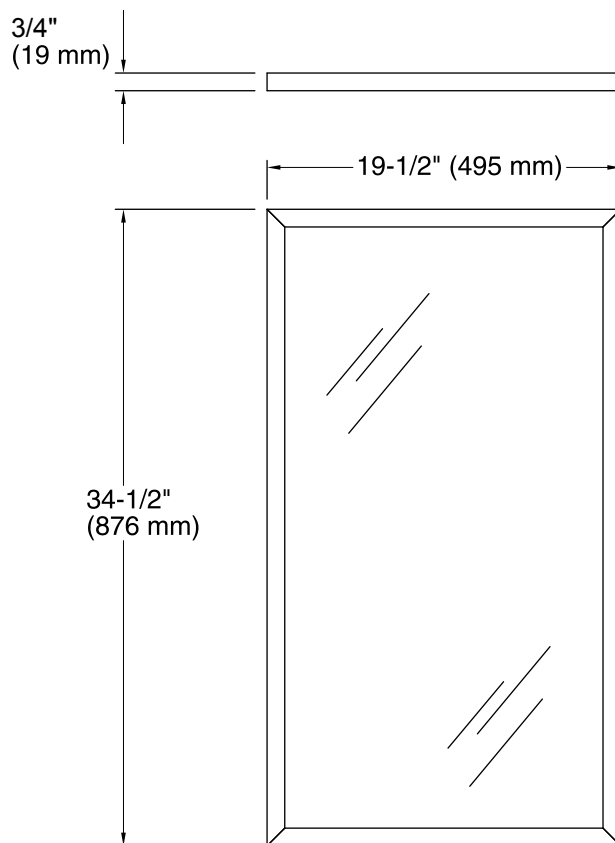

## Technical Information

All product dimensions are nominal.