

Features

- Catalyzed conversion varnish provides a durable moisture-resistant finish.
- Frameless construction with full-overlay doors and drawers.
- Two doors and four full- and four shallow-drawers behind six drawer fronts.
- Three-way adjustable slow-close door hinges with 110-degree opening capability for easy cabinet access.
- Optional adjustable shelf, rollout drawer, rollout tray (sold separately).
- Coordinates with other products in the Damask™ collection.
- Full-extension 18" depth drawers with slow-close under-mount slides for smooth opening.
- Solid wood drawers with dovetail construction.
- Door and drawer pulls are sold separately.

Material

- Solid wood and veneers.

Recommended Accessories

2891
2783
K-5458 Bathroom Vanity Top
K-5424 Bathroom Vanity Top
K-5439 Bathroom Vanity Top
K-99686 Knob
K-99689 Handle

Optional Accessories

99680
99679
K-99665 Framed Mirror
K-99681 Side Mount Electrical Outlets
K-99682 General Storage
K-99683 Makeup Storage
K-99684 Drawer Dividers
K-99672 Two-Drawer Bridge
K-99668 Lap Drawer
K-99676 Filler Strip
K-99001 Mirrored Cabinet
K-99007 Mirrored Cabinet
K-99009 Mirrored Cabinet
99662
99678



Codes/Standards











CARB P2

KOHLER® One-Year Limited Warranty

See website for detailed warranty information.

Available Color/Finishes

Color tiles intended for reference only.

Color	Code	Description
	1WA	Linen White
	1WF	Khaki White Oak
	1WD	Ramie Walnut
	1WG	Cherry Tweed
	1WB	Claret Suede
	1WH	Woolen Oak
	1WC	Felt Grey
	1WE	Terry Walnut
	1WT	Mohair Grey
	1WU	Batiste Black

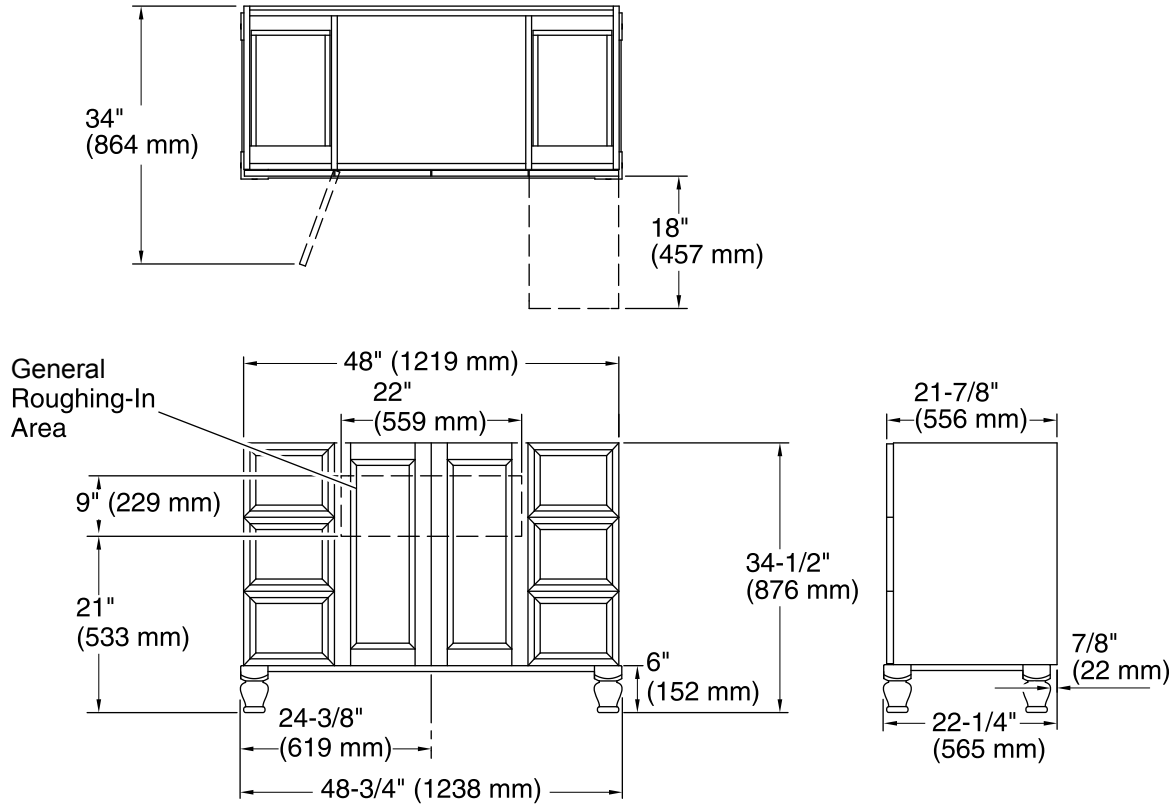

Technical Information

All product dimensions are nominal.

Vanity type: Standard

Notes

Install this product according to the installation guide.

Decorative cabinet hardware is not supplied. Refer to the KOHLER bath accessories line for recommended cabinet hardware to complement your vanity.

Select the type of fastener based upon the wall material. Two 250 lb (113.4 kg) minimum load bearing fasteners are recommended.