

Features

- Catalyzed conversion varnish provides a durable moisture-resistant finish.
- Frameless construction with full-overlay doors.
- Two doors.
- Three-way adjustable slow-close door hinges with 110-degree opening capability for easy cabinet access.
- Optional adjustable shelf (sold separately).
- Coordinates with other products in the Jacquard™ collection.
- Door pulls are sold separately.

Material

- Solid wood and veneers.

Recommended Accessories

2791

2777

K-5455 Bathroom Vanity Top

K-5421 Bathroom Vanity Top

K-5436 Bathroom Vanity Top

K-99686 Knob

K-99689 Handle

Optional Accessories

99680

99679

K-99665 Framed Mirror

K-99681 Side Mount Electrical Outlets

K-99682 General Storage

K-99683 Makeup Storage

K-99684 Drawer Dividers

K-99672 Two-Drawer Bridge

K-99668 Lap Drawer

K-99676 Filler Strip

K-99001 Mirrored Cabinet

K-99007 Mirrored Cabinet

K-99009 Mirrored Cabinet

99662

99678



Codes/Standards











CARB P2

KOHLER® One-Year Limited Warranty

See website for detailed warranty information.

Available Color/Finishes

Color tiles intended for reference only.

| Color | Code | Description |
|--|------|-----------------|
|  | 1WA | Linen White |
|  | 1WF | Khaki White Oak |
|  | 1WD | Ramie Walnut |
|  | 1WG | Cherry Tweed |
|  | 1WB | Claret Suede |
|  | 1WH | Woolen Oak |
|  | 1WC | Felt Grey |
|  | 1WE | Terry Walnut |
|  | 1WT | Mohair Grey |
|  | 1WU | Batiste Black |

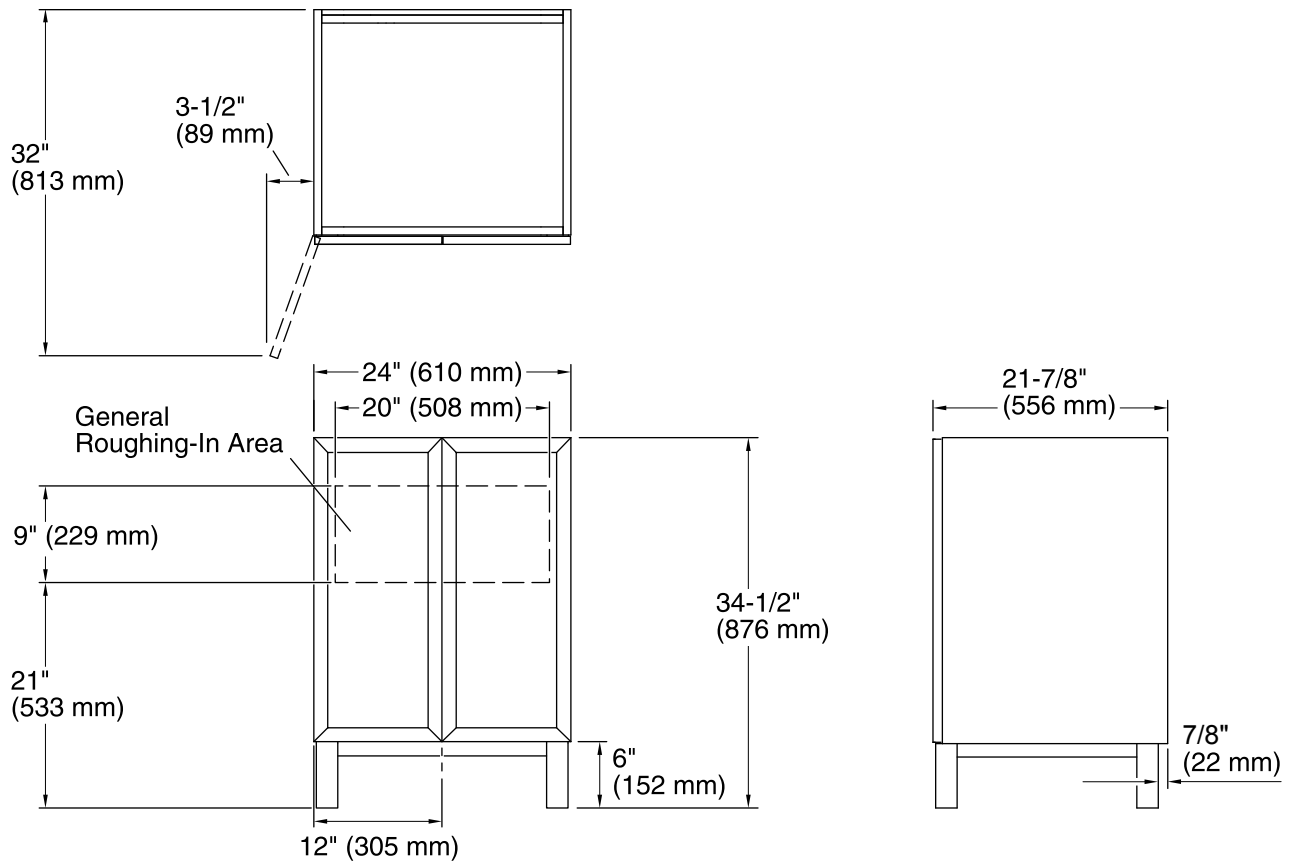

Technical Information

All product dimensions are nominal.

Vanity type: Standard

Notes

Install this product according to the installation guide.

Decorative cabinet hardware is not supplied. Refer to the KOHLER bath accessories line for recommended cabinet hardware to complement your vanity.

Select the type of fastener based upon the wall material. Two 250 lb (113.4 kg) minimum load bearing fasteners are recommended.