

Features

- Two swing lever handles offer separate control of hot and cold water.
- Bath spout sold separately.
- Coordinates with other products in the Artifacts collection.

Material

- Premium metal construction.
- KOHLER finishes resist corrosion and tarnishing.

Installation

- Deck-mount



ADA

Codes/Standards







ASME A112.18.1/CSA B125.1
ADA

Kohler Faucet Lifetime Limited Warranty

See website for detailed warranty information.

Available Color/Finishes

Color tiles intended for reference only.

Color	Code	Description
	CP	Polished Chrome
	SN	Vibrant® Polished Nickel
	BN	Vibrant® Brushed Nickel
	BV	Vibrant® Brushed Bronze
	2BZ	Oil-Rubbed Bronze
	VNT	Vintage Nickel

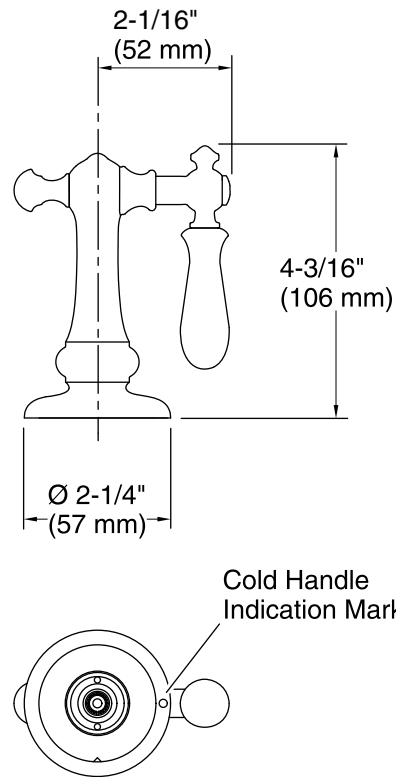

Technical Information

All product dimensions are nominal.

Notes

IMPORTANT! Artifacts deck-mount handles are only compatible with the valve included with the Artifacts deck-mount faucets. Do not install to a K-300 bath valve.

IMPORTANT! For K-T98071-9M models, the handle swings up and toward the user. Ensure that the handle will not interfere with the bath fixture during operation.

For K-T98071-9M models, the setscrews face the back of the faucet when properly installed. A circular mark on the bottom of the handle indicates the cold handle.

Install this product according to the installation guide.

ADA compliant when installed to the specific requirements of these regulations.