



Features

- Integral flange.
- Comfort Depth® design offers a 19" (483 mm) step-over height.
- Slotted overflow for deep soaking.
- Left drain.
- Integral lumbar support and armrests for comfort.
- Integral apron with removable access panel.

Hydrotherapy

- 118 BubbleMassage™ airjets.
- Single-speed whirlpool offers eight fully adjustable hydro-massage jets for water flow and direction.
- Automatic purge cycles remove residual water from air channels after use.
- Pump with air switch for whirlpool.
- Lighted keypad control.
- Built-in 1500 W heater.

Installation

- Alcove

Required Accessories

K-7271 Brass Slotted Overflow Bath Drain

or

K-7272 PVC Slotted Overflow Bath Drain

Recommended Accessories

K-9529 Removable Bath Seat

K-24916 Wireless Music Kit



ADA

Codes/Standards

ASME A112.19.7/CSA B45.10

CSA B45.5/IAPMO Z124

ASTM E162

ASTM E662

UL 1795

Greenguard UL 2818 - Gold

ADA

ICC/ANSI A117.1









CARB P2

KOHLER® One-Year Limited Warranty

See website for detailed warranty information.

Available Color/Finishes

Color tiles intended for reference only.

Color	Code	Description
	0	White
	96	Biscuit
	47	Almond
	NY	Dune
	95	Ice™ Grey
	G9	Sandbar
	33	Mexican Sand™
	K4	Cashmere

6' BubbleMassage™ Whirlpool Bath K-1124-XHGLA

No change in measurements if connected with drain illustrated. (K-7272)

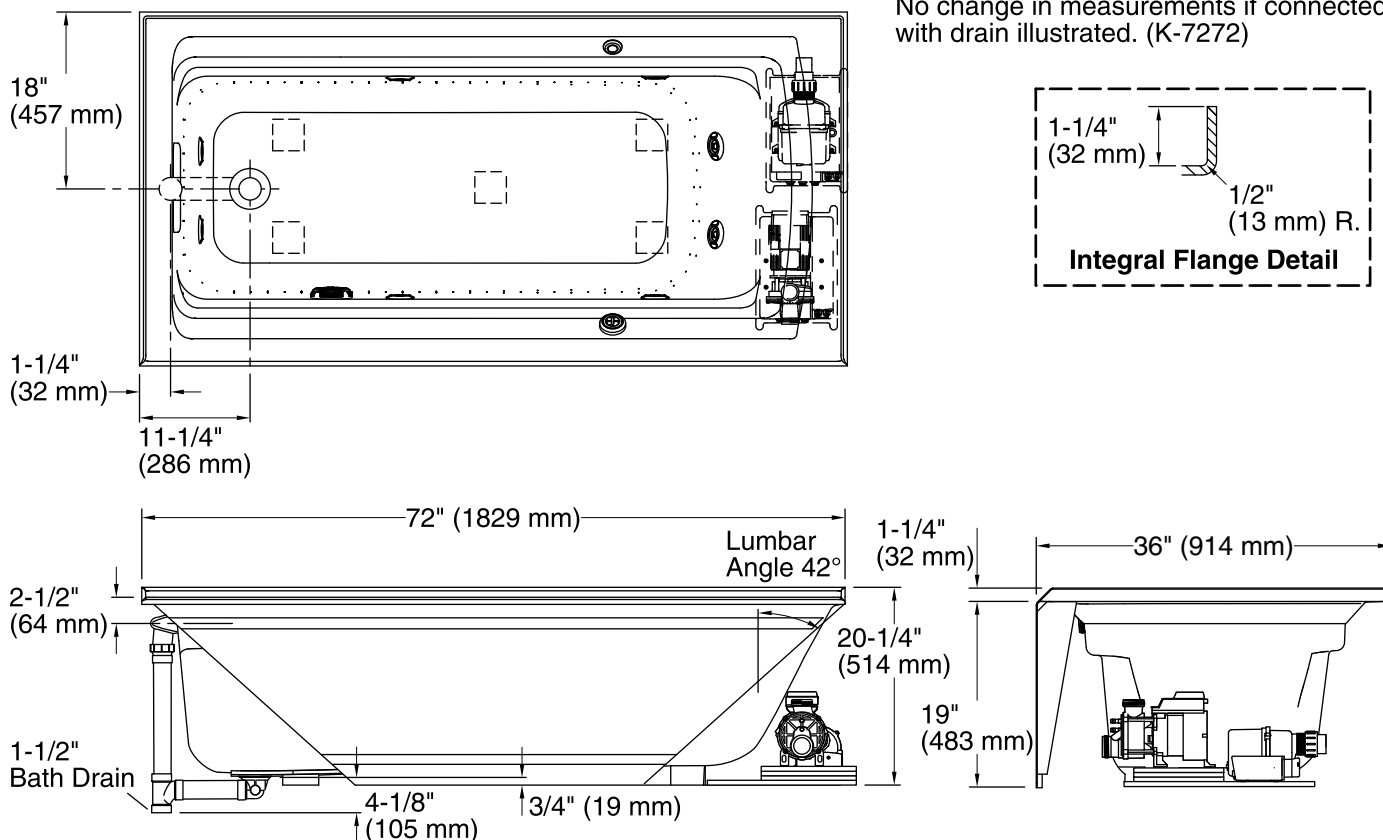

Required Electrical Service

Three dedicated circuits required, protected with Class A Ground-Fault Circuit-Interrupter (GFCI) or Residual Current Device (RCD).

Pump:	120 V, 15 A, 60 Hz
Blower:	120 V, 15 A, 60 Hz
Heater:	120 V, 15 A, 60 Hz

Technical Information

All product dimensions are nominal.

Installation:	3-Wall Alcove
Drain location:	Left
Basin area, bottom:	51-3/8" x 21" (1305 mm x 533 mm)
Basin area, top:	64-1/2" x 30-1/2" (1638 mm x 775 mm)
Weight:	150 lbs (68 kg)
Minimum floor load:	44.2 lbs/ft ² (215.8 kg/m ²)
Water depth:	15" (381 mm)
Water capacity:	72 gal (272.5 L)
Electrical component rating:	Pump: 120 V, 7 A, 60 Hz Blower: 120 V, 10 A, 60 Hz Heater: 120 V, 12.5 A, 60 Hz
Minimum flat for door:	1-9/16" (40 mm)

Notes

Measure your actual product for rough-in details.

Install this product according to the installation instructions.

The hot water supply should be 70% of the capacity of the bath or greater. Installations will vary.

Provide one grounded electrical outlet within 24" (610 mm) of each component.

Remote blower installation kit is available for relocating the blower. Provide access for servicing the blower.

Do not relocate or alter the PVC tee or coiled flexible tubing connected to the blower. Follow the blower relocation instructions exactly.

ADA compliant when installed to the specific requirements of these regulations.