



### Features

- End drain.
- Slotted overflow for deep soaking.
- VibrAcoustic® technology emits sound waves and offers a surround sound experience.
- Six transducers and a control amplifier with 25' (7.6 m) of wiring.
- High-resolution color screen in polished chrome.
- Bask® heated surface creates spa-like relaxation with soothing warmth on your back, shoulders, and neck.
- Chromatherapy lighting allows you to select a preferred color scheme to suit your mood.
- Integral lumbar support.
- 66" (1676 mm) x 36" (914 mm) x 22" (559 mm)

### Material

- Acrylic

### Hydrotherapy

- 122 BubbleMassage™ airjets.
- Variable-speed blower for adjusting hydromassage intensity.
- Automatic purge cycles remove residual water from air channels after use.
- Built-in 300 W heater.

### Installation

- Drop-in or under-mount.

### Required Accessories

K-7271 Brass Slotted Overflow Bath Drain

or

K-7272 PVC Slotted Overflow Bath Drain

### Recommended Accessories

1184460 Kit, UI Mounting

K-591 Under-mount Installation Kit



### Codes/Standards

ASME A112.19.7/CSA B45.10

CSA B45.5/IAPMO Z124

ASTM E162

ASTM E662

UL 1795

Greenguard UL 2818 - Gold











CARB P2

### KOHLER® One-Year Limited Warranty

See website for detailed warranty information.

### Available Color/Finishes

*Color tiles intended for reference only.*

Color	Code	Description
	0	White
	96	Biscuit
	47	Almond
	NY	Dune
	95	Ice™ Grey
	G9	Sandbar
	33	Mexican Sand™
	K4	Cashmere
	58	Thunder™ Grey
	7	Black Black™

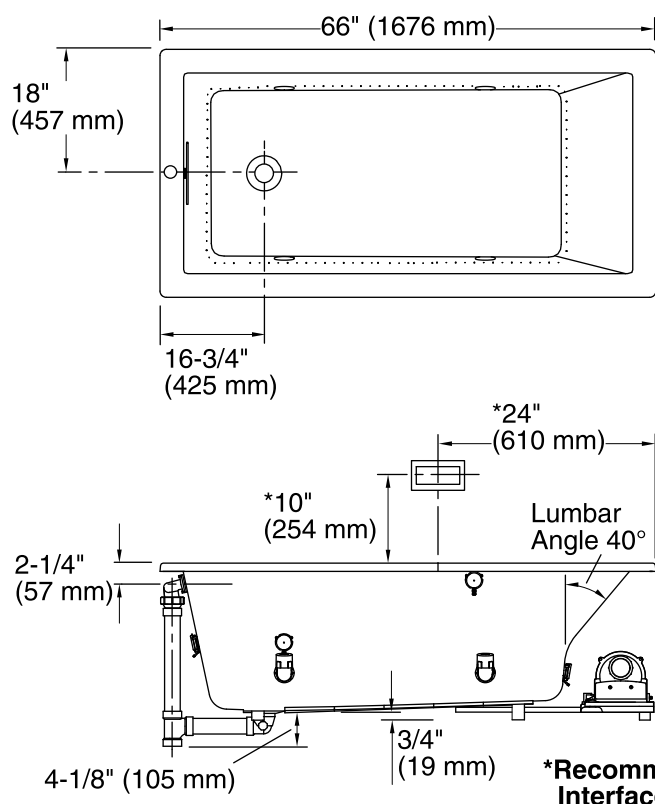

No change in measurement if connected with drain illustrated. (K-7272)

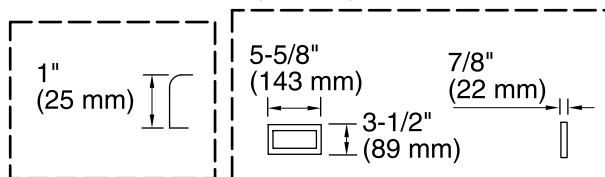

**Drop-in Rim Detail**

**User Interface**

Control Access  
30" (762 mm) W  
x 15" (381 mm) H  
Min

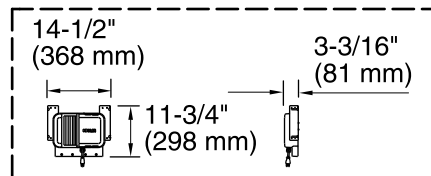

**Control Amplifier**

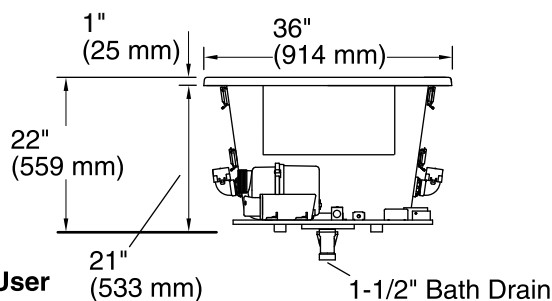

### Required Electrical Service

One dedicated circuit required, protected with Class A Ground-Fault Circuit-Interrupter (GFCI) or Residual Current Device (RCD).

Blower, Amplifier, 120 V, 15 A, 60 Hz  
Heated Surface:

### Technical Information

All product dimensions are nominal.

Installation:	Drop-in, Under-mount
Drain location:	End
Basin area, bottom:	44-1/2" x 26-1/2" (1130 mm x 673 mm)
Basin area, top:	60-1/4" x 30-1/4" (1530 mm x 768 mm)
Weight:	115 lbs (52.2 kg)
Minimum floor load:	64 lbs/ft <sup>2</sup> (312.5 kg/m <sup>2</sup> )
Water depth:	17-3/4" (451 mm)
Water capacity:	102 gal (386.1 L)
Cutout:	Drop-in, 65" x 35" (1651 mm x 889 mm)
Electrical component rating:	Blower: 120 V, 10 A, 60 Hz, 300 W Amplifier: 120 V, 1.2 A, 50/60 Hz, 15 W Heated Surface: 120 V, 0.5 A, 60 Hz, 65 W

### Notes

Measure your actual product for rough-in details.

Install this product according to the installation instructions.

The hot water supply should be 70% of the capacity of the bath or greater. Installations will vary.

Provide one grounded electrical outlet within 24" (610 mm) of each component.

Control amplifier fits 16" (406 mm) center studs. 25' (7.6 m) cables are included.

One electrical service may be used for the entire bath and related electrical components.

Remote blower installation kit K-1446 is available for relocating the blower. Provide access for servicing the blower.

Do not relocate or alter the PVC tee or coiled flexible tubing connected to the blower. Follow the blower relocation instructions exactly.