



### Features

- Comfort Depth® design offers a 19" (483 mm) step-over height.
- End drain.
- Slotted overflow for deep soaking.
- Bask® heated surface creates spa-like relaxation with soothing warmth on your back, shoulders, and neck.
- Integral lumbar support and armrests for comfort.
- Textured bottom surface.
- Coordinates with other products in the Archer® collection.
- 60" (1524 mm) x 32" (813 mm) x 19" (483 mm)

### Material

- Acrylic

### Hydrotherapy

- Single-speed whirlpool offers eight fully adjustable hydro-massage jets for water flow and direction.

### Installation

- Drop-in

### Required Accessories

K-7271 Brass Slotted Overflow Bath Drain

or

K-7272 PVC Slotted Overflow Bath Drain

### Recommended Accessories

K-24916 Wireless Music Kit



### Codes/Standards

CSA B45.5/IAPMO Z124

ASTM E162

ASTM E662











Greenguard UL 2818 - Gold

### KOHLER® One-Year Limited Warranty

See website for detailed warranty information.

### Available Color/Finishes

*Color tiles intended for reference only.*

| Color  | Code | Description   |
|--|------|---------------|
|  | 0    | White         |
|  | 96   | Biscuit       |
|  | 47   | Almond        |
|  | NY   | Dune          |
|  | 95   | Ice™ Grey     |
|  | G9   | Sandbar       |
|  | 33   | Mexican Sand™ |
|  | K4   | Cashmere      |
|  | 58   | Thunder™ Grey |
|  | 7    | Black Black™  |

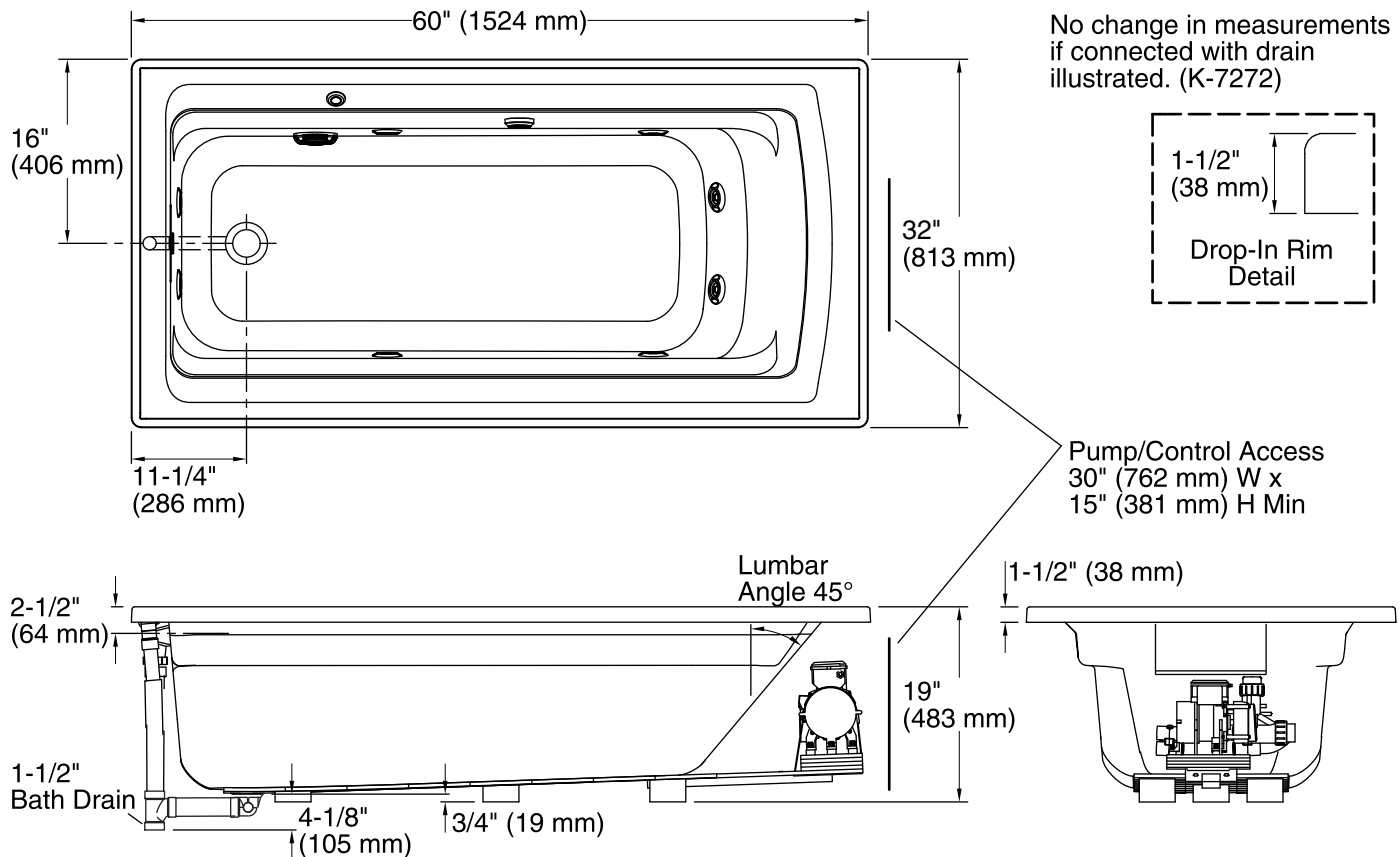

No change in measurements if connected with drain illustrated. (K-7272)

### Required Electrical Service

One dedicated circuit required, protected with Class A Ground-Fault Circuit-Interrupter (GFCI) or Residual Current Device (RCD).

Pump, Heated 120 V, 15 A, 60 Hz  
Surface:

### Technical Information

All product dimensions are nominal.

|                              |  |
|------------------------------|--|
| Installation:                | Drop-in  |
| Drain location:              | End  |
| Basin area, bottom:          | 45-1/8" x 19-11/16" (1146 mm x 500 mm)                         |
| Basin area, top:             | 52-3/4" x 25-5/16" (1340 mm x 643 mm)                          |
| Weight:                      | 116 lbs (52.6 kg)  |
| Minimum floor load:          | 46 lbs/ft <sup>2</sup> (224.6 kg/m <sup>2</sup> )              |
| Water depth:                 | 15" (381 mm)   |
| Water capacity:              | 58 gal (219.6 L)   |
| Cutout:                      | Drop-in, 58-1/2" x 30-1/2" (1486 mm x 775 mm)                  |
| Electrical component rating: | Pump: 120 V, 7 A, 60 Hz<br>Heated Surface: 120 V, 0.5 A, 60 Hz |
| Pump speed:                  | Single   |

### Notes

Measure your actual product for rough-in details.

Install this product according to the installation instructions.

The hot water supply should be 70% of the capacity of the bath or greater. Installations will vary.

Provide one grounded electrical outlet within 24" (610 mm) of each component.

This product is designed for drop-in installation only. It is not suited for use in a three-wall alcove with an overhead shower.