



Features

- Integral flange.
- Right drain.
- Integral lumbar support and armrests for comfort.
- Integral apron with removable access panel.
- Textured bottom surface.
- 66" (1676 mm) x 36" (914 mm) x 20" (508 mm)

Material

- Acrylic

Hydrotherapy

- 120 BubbleMassage™ airjets.
- Zones of Control feature allows you to target massage to back, midsection, or feet.
- Automatic purge cycles remove residual water from air channels after use.
- Built-in 300 W heater.
- Lighted keypad control.

Installation

- Alcove

Recommended Accessories

- K-1446 Remote Installation Kit
- K-1491 Bath/Whirlpool Pillow
- K-1601 Bath/Whirlpool Footstop
- K-7166-AF Bath Drain
- K-24916 Wireless Music Kit
- K-1234 Apron
- K-37380 30" Rough-in Cable Bath Drain
- K-37383 30" Rough-in Cable Bath Drain



Codes/Standards





ASME A112.19.7/CSA B45.10
CSA B45.5/IAPMO Z124
ASTM E162
ASTM E662
UL 1795
Greenguard UL 2818 - Gold
CARB P2

KOHLER® One-Year Limited Warranty

See website for detailed warranty information.

Available Color/Finishes

Color tiles intended for reference only.

| Color | Code | Description |
|--|------|-------------|
|  | 0 | White |
|  | 96 | Biscuit |
|  | 47 | Almond |
|  | NY | Dune |
|  | G9 | Sandbar |

No change in measurements if connected with drain illustrated. (K-7166-AF)

Recommended faucet area.

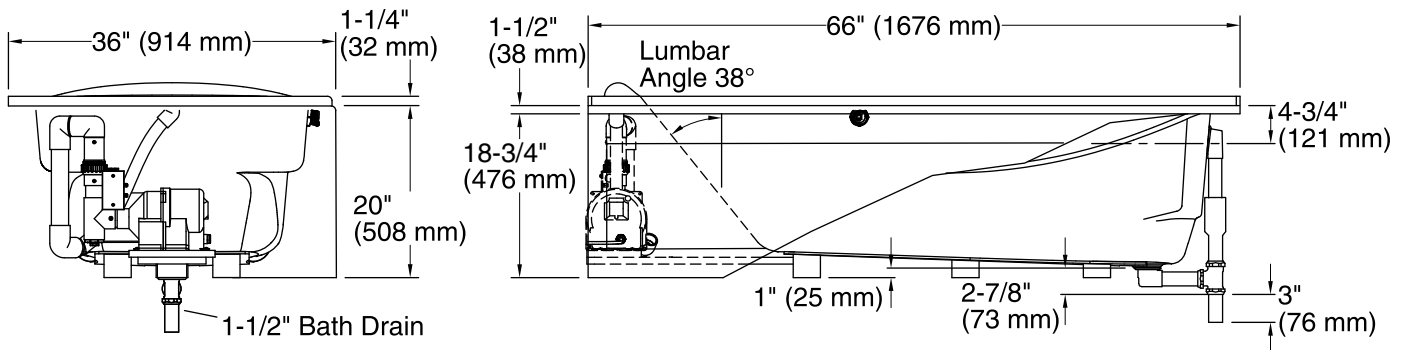
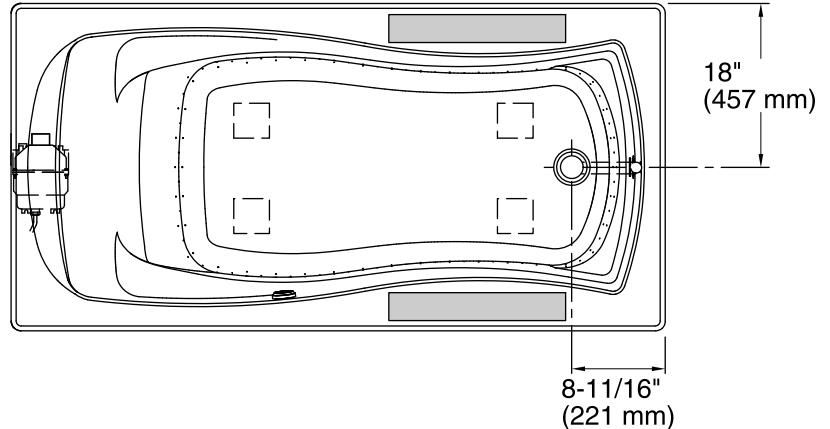
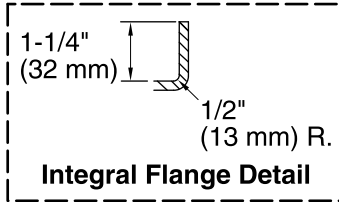

Required Electrical Service

One dedicated circuit required, protected with Class A Ground-Fault Circuit-Interrupter (GFCI) or Residual Current Device (RCD).

Blower: 120 V, 15 A, 60 Hz

Technical Information

All product dimensions are nominal.

Installation: 3-Wall Alcove
 Drain location: Right
 Basin area, bottom: 48" x 24" (1219 mm x 610 mm)
 Basin area, top: 59" x 30" (1499 mm x 762 mm)
 Weight: 109 lbs (49.4 kg)
 Minimum floor load: 42 lbs/ft² (205.1 kg/m²)
 Water depth: 14" (356 mm)
 Water capacity: 67 gal (253.6 L)
 Electrical component rating: Blower: 120 V, 10 A, 60 Hz, 300 W
 Minimum flat for door: 1-15/16" (49 mm)

Notes

Measure your actual product for rough-in details.

Install this product according to the installation instructions.

The hot water supply should be 70% of the capacity of the bath or greater. Installations will vary.

Provide one grounded electrical outlet within 24" (610 mm) of each component.

Remote blower installation kit K-1446 is available for relocating the blower. Provide access for servicing the blower.

Do not relocate or alter the PVC tee or coiled flexible tubing connected to the blower. Follow the blower relocation instructions exactly.