



### Features

- Integral flange.
- Left drain.
- Integral lumbar support and armrests for comfort.
- Integral apron with removable access panel.
- Textured bottom surface.
- 66" (1676 mm) x 36" (914 mm) x 20" (508 mm)

### Material

- Acrylic

### Hydrotherapy

- 120 BubbleMassage™ airjets.
- Zones of Control feature allows you to target massage to back, midsection, or feet.
- Automatic purge cycles remove residual water from air channels after use.
- Built-in 300 W heater.
- Lighted keypad control.

### Installation

- Alcove

### Recommended Accessories

- K-1446 Remote Installation Kit
- K-1491 Bath/Whirlpool Pillow
- K-1601 Bath/Whirlpool Footstop
- K-7166-AF Bath Drain
- K-24916 Wireless Music Kit
- K-37380 30" Rough-in Cable Bath Drain
- K-37383 30" Rough-in Cable Bath Drain



### Codes/Standards





ASME A112.19.7/CSA B45.10  
CSA B45.5/IAPMO Z124  
ASTM E162  
ASTM E662  
UL 1795  
Greenguard UL 2818 - Gold  
CARB P2

### KOHLER® One-Year Limited Warranty

See website for detailed warranty information.

### Available Color/Finishes

*Color tiles intended for reference only.*

Color	Code	Description
	0	White
	96	Biscuit
	47	Almond
	NY	Dune
	G9	Sandbar

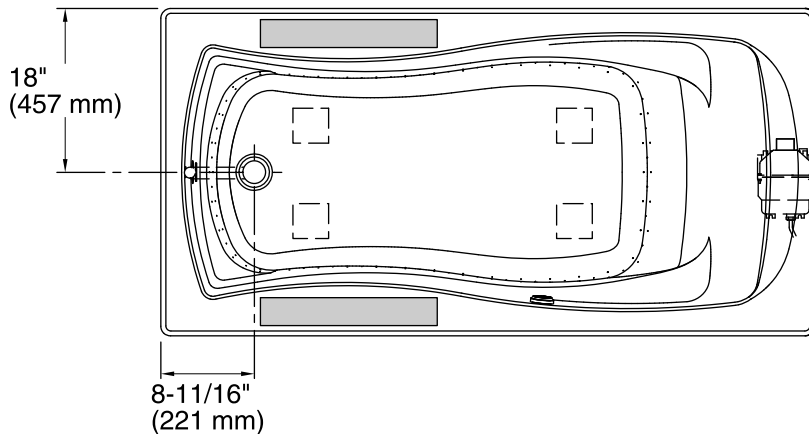

No change in measurements if connected with drain illustrated. (K-7166-AF)

■ Recommended faucet area.

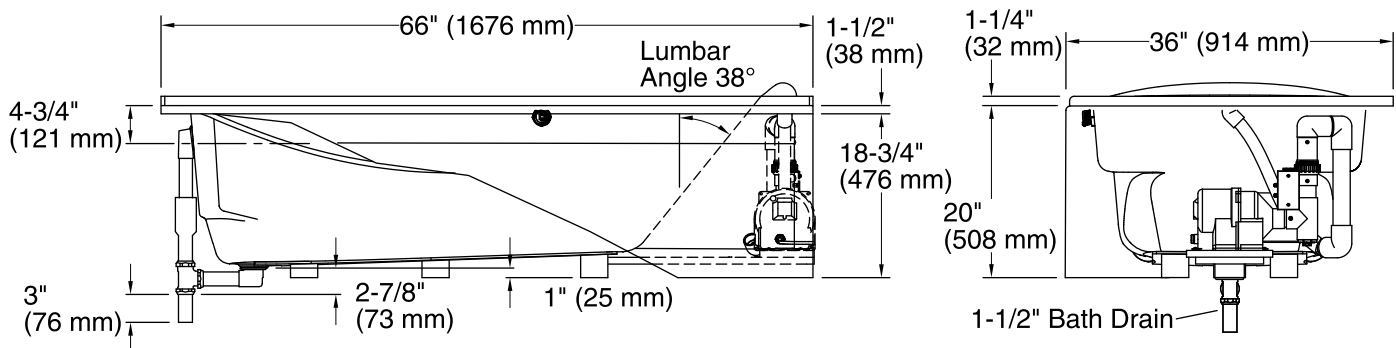
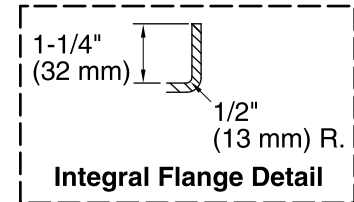

### Required Electrical Service

One dedicated circuit required, protected with Class A Ground-Fault Circuit-Interrupter (GFCI) or Residual Current Device (RCD).

Blower: 120 V, 15 A, 60 Hz

### Technical Information

All product dimensions are nominal.

Installation: 3-Wall Alcove

Drain location: Left

Basin area, bottom: 48" x 24" (1219 mm x 610 mm)

Basin area, top: 59" x 30" (1499 mm x 762 mm)

Weight: 109 lbs (49.4 kg)

Minimum floor load: 42 lbs/ft<sup>2</sup> (205.1 kg/m<sup>2</sup>)

Water depth: 14" (356 mm)

Water capacity: 67 gal (253.6 L)

Electrical component rating: Blower: 120 V, 10 A, 60 Hz, 300 W

Minimum flat for door: 1-15/16" (49 mm)

### Notes

Measure your actual product for rough-in details.

Install this product according to the installation instructions.

The hot water supply should be 70% of the capacity of the bath or greater. Installations will vary.

Provide one grounded electrical outlet within 24" (610 mm) of each component.

Remote blower installation kit K-1446 is available for relocating the blower. Provide access for servicing the blower.

Do not relocate or alter the PVC tee or coiled flexible tubing connected to the blower. Follow the blower relocation instructions exactly.