



Features

- Comfort Depth® design offers a 19" (483 mm) step-over height.
- End drain.
- Slotted overflow for deep soaking.
- Bask® heated surface with three temperature settings creates spa-like relaxation with soothing warmth on your back, shoulders, and neck.
- 60" (1524 mm) x 30" (762 mm) x 19" (483 mm)

Material

- Acrylic

Installation

- Drop-in or under-mount.
- Integral lumbar support.

Required Accessories

K-7271 Brass Slotted Overflow Bath Drain

or

K-7272 PVC Slotted Overflow Bath Drain

Recommended Accessories

K-531 Under-mount Installation Kit

K-1491 Bath/Whirlpool Pillow

K-1601 Bath/Whirlpool Footstop

K-24916 Wireless Music Kit



ADA

Codes/Standards

CSA B45.5/IAPMO Z124

ASTM E162

ASTM E662

Greenguard UL 2818 - Gold

ADA

ICC/ANSI A117.1









CARB P2

KOHLER® One-Year Limited Warranty

See website for detailed warranty information.

Available Color/Finishes

Color tiles intended for reference only.

Color	Code	Description
	0	White
	96	Biscuit
	47	Almond
	NY	Dune
	95	Ice™ Grey
	G9	Sandbar
	K4	Cashmere
	58	Thunder™ Grey
	7	Black Black™

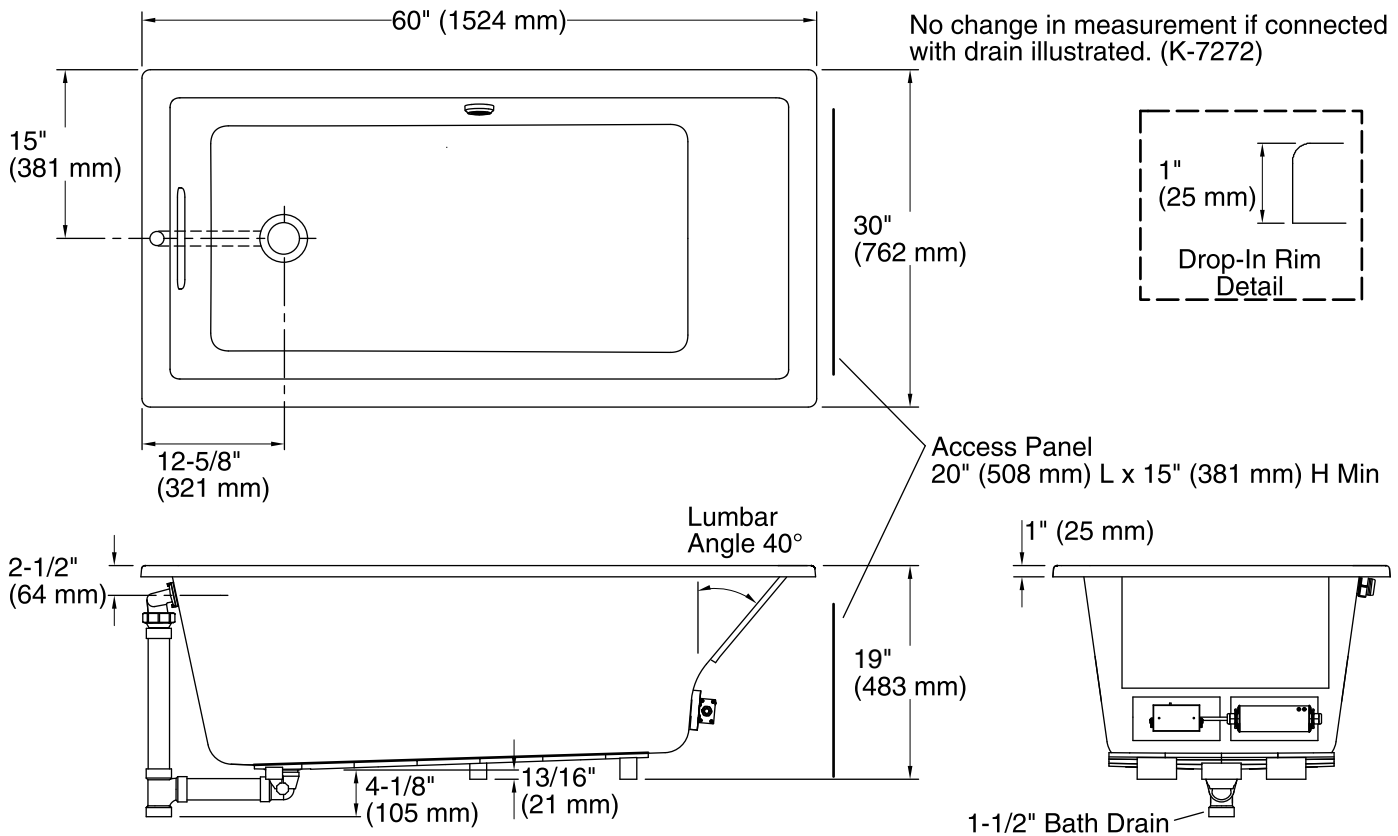

Required Electrical Service

One circuit required, protected with Class A Ground-Fault Circuit-Interrupter (GFCI) or Residual Current Device (RCD).

Heated Surface: 120 V, 15 A

Technical Information

All product dimensions are nominal.

Installation:	Drop-in, Under-mount
Drain location:	End
Basin area, bottom:	42-3/8" x 20" (1076 mm x 508 mm)
Basin area, top:	54-3/8" x 24-5/16" (1381 mm x 618 mm)
Weight:	77 lbs (34.9 kg)
Minimum floor load:	50 lbs/ft ² (244.1 kg/m ²)
Water depth:	15-1/16" (383 mm)
Water capacity:	59.8 gal (226.4 L)
Cutout:	Drop-in, 59-1/2" x 28-1/2" (1511 mm x 724 mm)
Electrical component rating:	Heated Surface: 120 V, 0.5 A, 60 Hz
Minimum flat for door:	1-15/16" (50 mm)

Notes

Measure your actual product for rough-in details.

Install this product according to the installation instructions.

The hot water supply should be 70% of the capacity of the bath or greater. Installations will vary.

Provide one grounded electrical outlet within 24" (610 mm) of each component.

ADA compliant when installed to the specific requirements of these regulations.