

**FAUCET
K-T194**

ALSO K-T196, K-T198, K-307-K

ADA

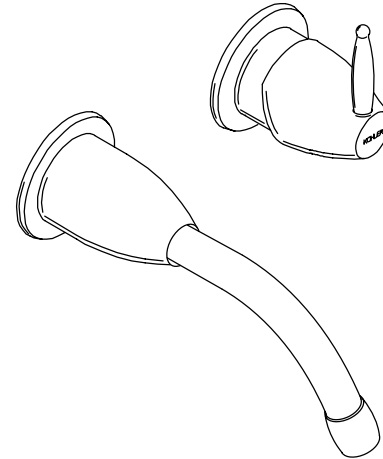

FEATURES

- Brass construction
- Available with 6-1/4", 8-1/4", or 10-1/4" spout
- 2.2 gallons per minute
- Available with lever

CODES/STANDARDS APPLICABLE

Specified model meets or exceeds the following:

- ASME/ANSI A112.18.1M
- CSA B125
- Energy Policy Act of 1992
- IAPMO/UPC
- NSF 61

COLORS/FINISHES

- CP Polished Chrome
- PB Polished Brass
- Other Refer to Faucets Price Book for additional finishes

SPECIFIED MODEL:

Model	Description	<input type="checkbox"/> CP	<input type="checkbox"/> PB	<input type="checkbox"/> Other
K-T194	With 6-1/4" Spout	<input type="checkbox"/>	<input type="checkbox"/>	<input type="checkbox"/>
K-T196	With 8-1/4" Spout	<input type="checkbox"/>	<input type="checkbox"/>	<input type="checkbox"/>
K-T198	With 10-1/4" Spout	<input type="checkbox"/>	<input type="checkbox"/>	<input type="checkbox"/>

Required Accessory		<input type="checkbox"/> NA
K-307-K	Wall Mount Valve	<input type="checkbox"/>

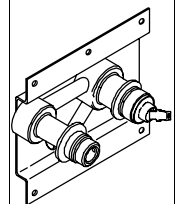





Optional Accessories on Page 2.

PRODUCT SPECIFICATION:

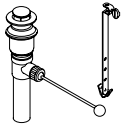
Single-control wall-mount faucet shall be of brass construction. Product shall include lever handle. Optional feature shall be 6-1/4", 8-1/4", or 10-1/4" spout. Trim shall be Kohler Model K-T_____ - _____ with K-307-K-NA valve.

FALLING WATER

Optional Accessories					
K-7702	Pop-Up Lavatory Drain	<input type="checkbox"/> CP <input type="checkbox"/> PB			
K-7710	Lavatory Drain		<input type="checkbox"/> CP		
K-7715	Lavatory Drain			<input type="checkbox"/> CP <input type="checkbox"/> PB	
K-8801	Duostrainer Sink Strainer				<input type="checkbox"/> CP <input type="checkbox"/> PB <input type="checkbox"/> Other_____

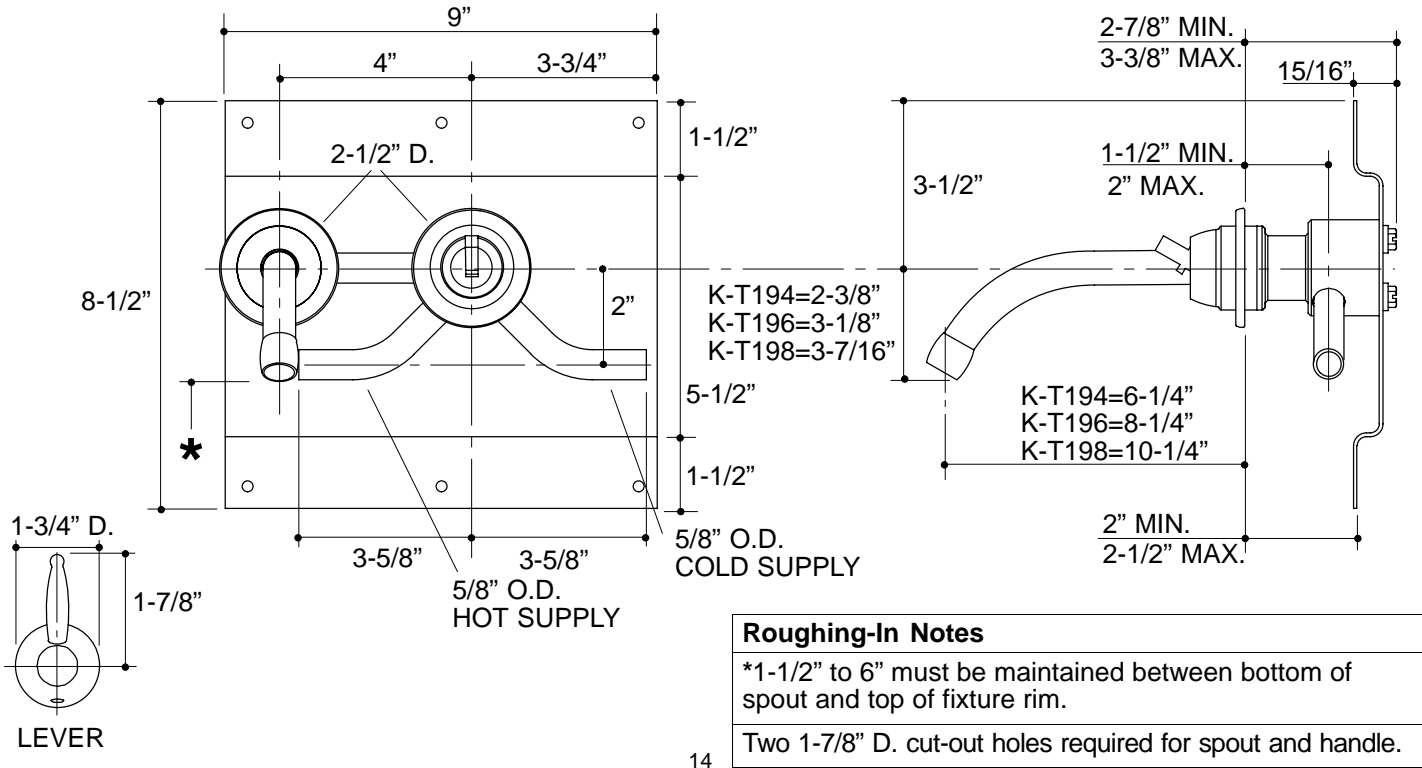

ROUGHING-IN NOTES

*1-1/2" to 6" must be maintained between bottom of spout and top of fixture rim.

Two 1-7/8" D. cut-out holes required for spout and handle.

PRODUCT DIAGRAM