

Features

- 36" minimum base cabinet width
- Single bowl
- 9" (229 mm) depth provides generous workspace
- Five oversized faucet holes
- Oversized holes allow for easy installation of faucets and accessories
- Bowl slopes toward drain to minimize water pooling
- Offset drain increases workspace in the sink and storage space underneath
- Includes K-6194 utility rack with soaking cup, K-6239 colander with integral cutting board, and K-6237 left-hand bottom sink rack

Material

- KOHLER® enameled cast iron

Installation

- Undermount

Required Products/Accessories

K-6237 Left-Bowl Sink Rack
K-6255 Right-Bowl Sink Rack

or

K-11352 Disposal Flange with Stopper

or

K-8801 Sink drain and strainer with tailpiece

or

K-8799 Sink drain and strainer basket

Recommended Products/Accessories

K-23725 Cast iron cleaner
K-23726 Drain treatment
1411886 Undermount sink kit 23"

Optional Products/Accessories

K-6246 Maple hardwood cutting board
K-5807 36" Under-mount Sink Kit
K-9000 P-Trap

Included Components

K-6194 Utility Rack With Soaking Cup
K-6237 Left-Bowl Sink Rack
K-6239 Colander with Cutting Board



Codes/Standards









ASME A112.19.1/CSA B45.2

KOHLER® Enameled Cast Iron Kitchen and Bathroom Sink Lifetime Limited Warranty

See website for detailed warranty information.

Available Colors/Finishes

Color tiles intended for reference only.

Color	Code	Description
	0	White
	FF	Sea Salt™
	96	Biscuit
	NY	Dune
	95	Ice™ Grey
	58	Thunder™ Grey
	7	Black Black™
	TRF	Truffle
	DGB	Indigo Blue

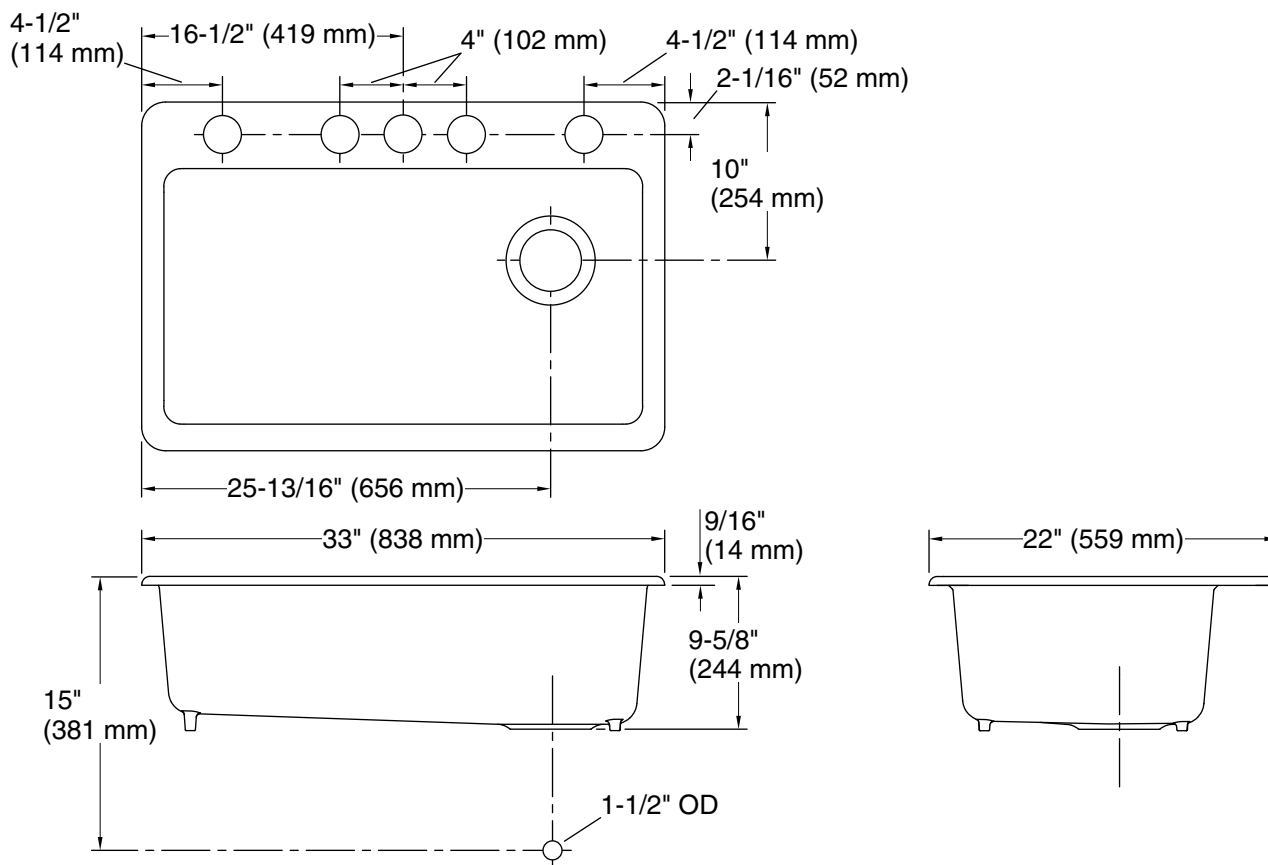

Technical Information

All product dimensions are nominal.

Bowl configuration:	Single
Min. base cabinet width:	36" (914 mm)
Bowl area (Only):	Length: 30-1/4" (768 mm) Width: 15-13/16" (402 mm) Bowl depth: 9" (229 mm)
Number of deck holes:	5
Faucet hole(s):	2-3/8" (60 mm)
Drain hole:	3-7/8" (98 mm)
Template:	1166727-7, required, included

Notes

Install this product according to the installation instructions.

NOTICE: Countertop manufacturer or cutter must use the cut-out template provided with the product, or a current one provided by Kohler Co. (call 1-800-4-KOHLER). Kohler Co. is not responsible for cutout errors when the incorrect cut-out template is used.