

## Features

- Vitreous china.
- Drop-in.
- Round basin.
- With overflow.
- 4-inch centers.
- 18-7/8" (480 mm) diameter

## Recommended Accessories

- K- 7107 Decorative drain
- K- 7108 Decorative Drain
- K- 7129 Drain
- K- 9018 P-Trap



ADA

## Codes/Standards











ASME A112.19.2/CSA B45.1  
ADA  
ICC/ANSI A117.1

## KOHLER® One-Year Limited Warranty

See website for detailed warranty information.

## Available Color/Finishes

*Color tiles intended for reference only.*

Color	Code	Description
	0	White
	96	Biscuit
	47	Almond
	NY	Dune
	95	Ice™ Grey
	G9	Sandbar
	33	Mexican Sand™
	K4	Cashmere
	58	Thunder™ Grey
	7	Black Black™

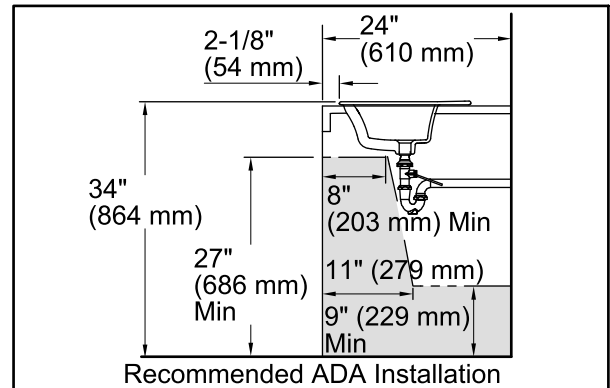
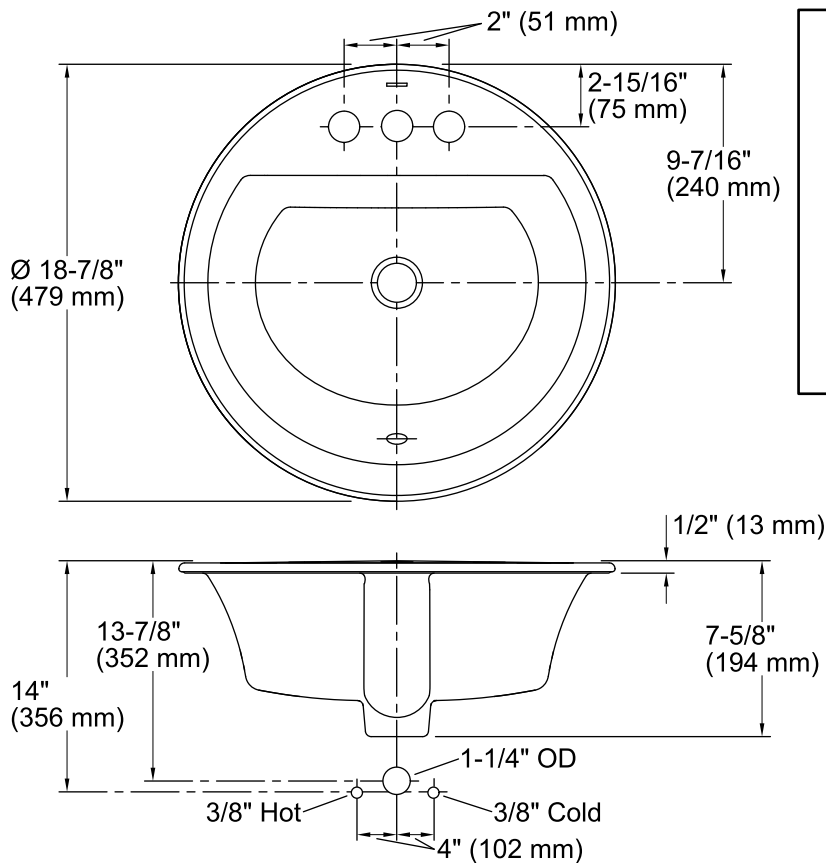

## Technical Information

All product dimensions are nominal.

Bowl configuration:	Single
Installation:	Drop-In
Bowl area (Only)	Length: 12-1/2" (318 mm) Width: 16-5/16" (414 mm) Water depth: 4" (102 mm)
Number of deck holes:	3
Faucet hole(s):	1-1/4" (32 mm)
Drain hole:	1-3/4" (44 mm)
Template:	Drop-in, 1155260-7, required, included

## Notes

Install this product according to the installation guide.

Spout must be 5" (12.7 cm) long (min) for adequate clearance into the lavatory when installed with the centerline as shown.

**NOTICE:** Countertop manufacturer or cutter must use the cut-out template provided with the product, or a current one provided by Kohler Co. (call 1-800-4-KOHLER). Kohler Co. is not responsible for cutout errors when the incorrect cut-out template is used.

ADA compliant when installed to the specific requirements of these regulations.