

Features

- Premium metal construction for durability.
- KOHLER finishes resist corrosion and tarnish.
- Coordinates with other products in the Purist Collection.

Installation

- Tools and installation template included.

Included Components

Additional Components:
Installation hardware



ADA

Codes/Standards







ADA
ICC/ANSI A117.1

KOHLER® Faucet Lifetime Limited Warranty

See website for detailed warranty information.

Available Colors/Finishes

Color tiles intended for reference only.

| Color | Code | Description |
|--|------|--------------------------|
|  | S | Polished Stainless |
|  | SN | Vibrant® Polished Nickel |
|  | BN | Vibrant® Brushed Nickel |
|  | BS | Brushed Stainless |
|  | BV | Vibrant® Brushed Bronze |
|  | TT | Vibrant Titanium |

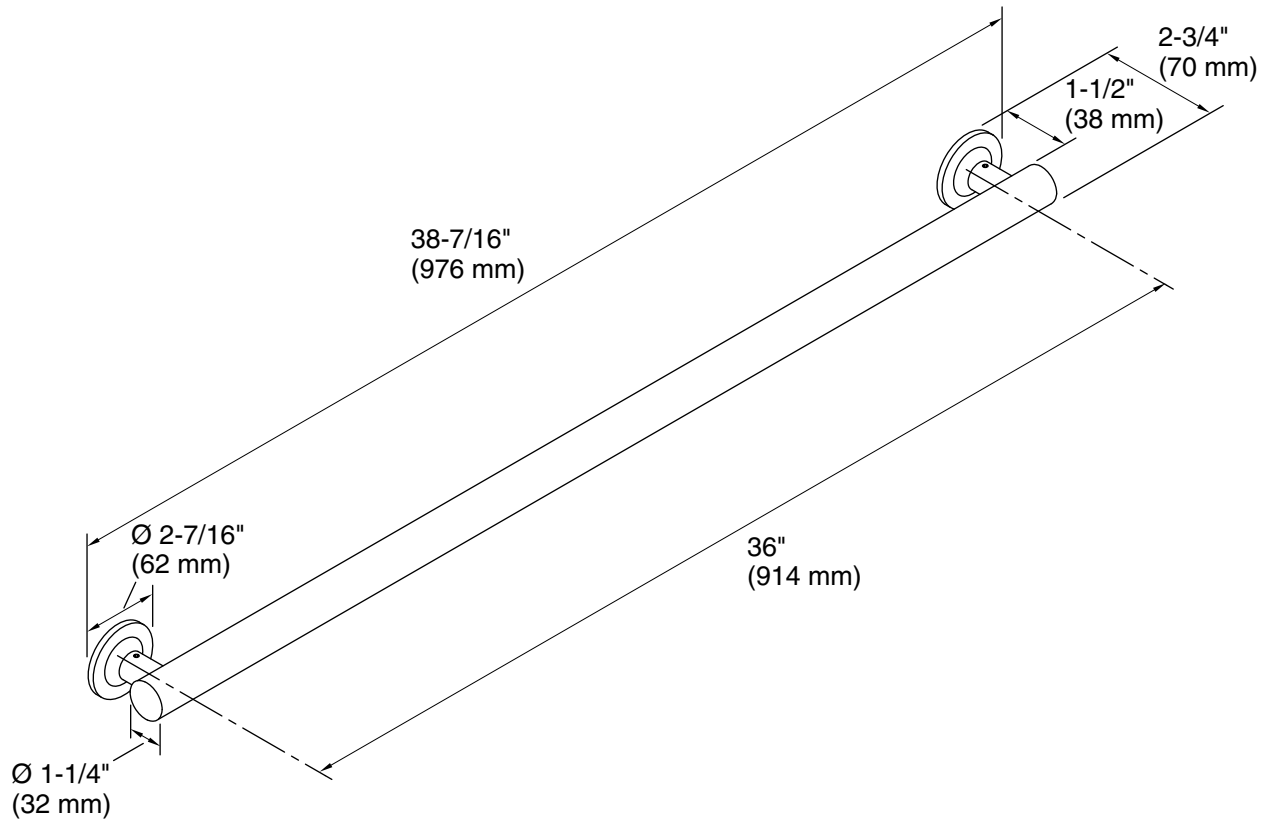

Technical Information

All product dimensions are nominal.

Material: Metal

Notes

Measure your actual product for roughing-in details.

WARNING: Risk of personal injury. The wall plates on the grab bar must be mounted to a brace between the wall studs. This will ensure that the weight of the user is adequately supported.

ADA compliant when installed to the specific requirements of these regulations.