



### Features

- Center drain.
- Integral lumbar support and armrests for comfort.
- Textured bottom surface.
- 60" (1524 mm) x 60" (1524 mm) x 21" (533 mm)

### Hydrotherapy

- Single-speed whirlpool offers six fully adjustable hydro-massage jets for water flow and direction.
- Pump with air switch for whirlpool.
- Built-in 1500 W heater.

### Installation

- Drop-in

### Recommended Accessories

- K-11677 Bath Drain
- K-1491 Bath/Whirlpool Pillow
- K-1601 Bath/Whirlpool Footstop
- K-9696 Whirlpool 6-Jet Trim Kit
- K-7259 Clearflo Bath Drain
- K-37382 45" Rough-in Cable Bath Drain



### Codes/Standards



- ASME A112.19.7/CSA B45.10
- CSA B45.5/IAPMO Z124
- ASTM E162
- ASTM E662
- UL 1795
- Greenguard UL 2818 - Gold

### KOHLER® One-Year Limited Warranty

See website for detailed warranty information.

### Available Color/Finishes

*Color tiles intended for reference only.*

Color	Code	Description
	0	White
	96	Biscuit
	47	Almond

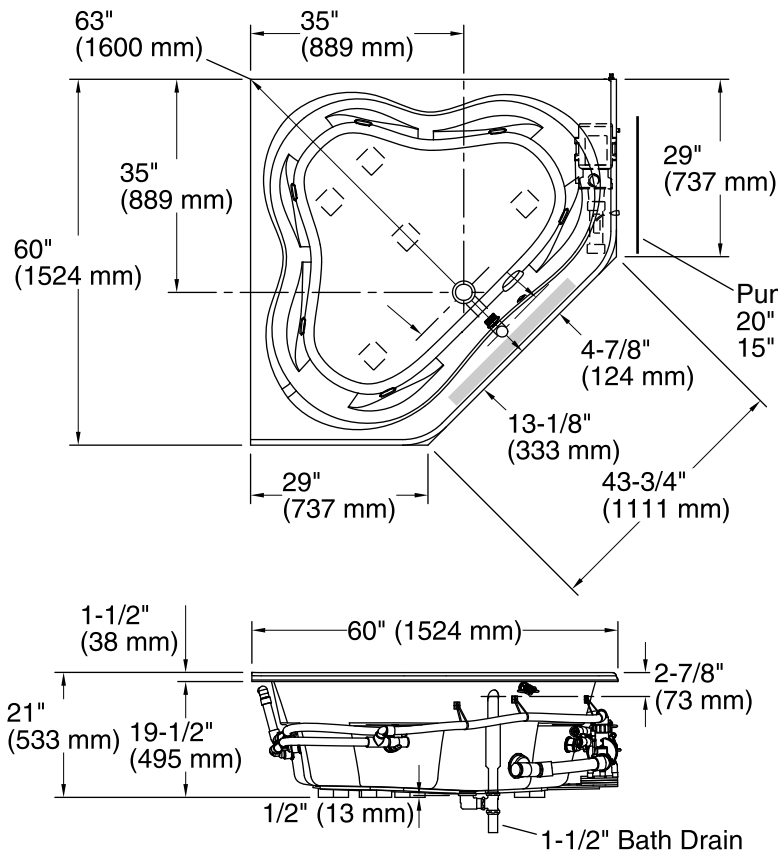

No change in measurements if connected with drain illustrated. (K-11677)

■ Recommended faucet area

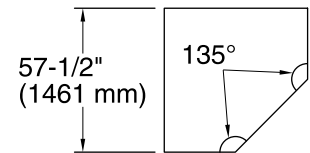
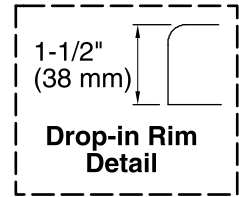

27-1/2" (699 mm)

Lumbar Angle 15°

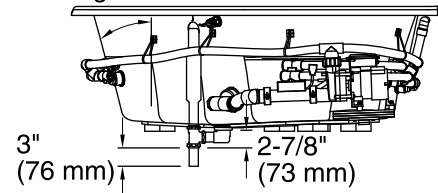

### Required Electrical Service

Two dedicated circuits required, protected with Class A Ground-Fault Circuit-Interrupter (GFCI) or Residual Current Device (RCD).

Pump: 120 V, 15 A, 60 Hz  
Heater: 120 V, 15 A, 60 Hz

### Technical Information

All product dimensions are nominal.

Installation: Drop-in  
Drain location: Center  
Basin area, bottom: 52" x 38-3/4" (1321 mm x 984 mm)  
Basin area, top: 61" x 46-1/4" (1549 mm x 1175 mm)  
Weight: 131 lbs (59.4 kg)  
Minimum floor load: 39 lbs/ft<sup>2</sup> (190.4 kg/m<sup>2</sup>)  
Water depth: 15" (381 mm)  
Water capacity: 96 gal (363.4 L)  
Electrical component rating: Pump: 120 V, 7.5 A, 60 Hz  
Heater: 120 V, 12.5 A, 60 Hz, 1500 W  
Pump speed: Single

### Notes

Measure your actual product for rough-in details.

Install this product according to the installation instructions.

The hot water supply should be 70% of the capacity of the bath or greater. Installations will vary.

Provide one grounded electrical outlet within 24" (610 mm) of each component.