



### Features

- Center drain.
- Slotted overflow for deep soaking.
- Integral lumbar support.
- 72" (1829 mm) x 42" (1067 mm) x 23" (584 mm)

### Material

- Acrylic

### Hydrotherapy

- Eight fully adjustable Flexjet™ hydrotherapy jets for water flow and direction.
- Built-in 1500 W heater.
- Lighted keypad control.

### Installation

- Drop-in or under-mount.

### Required Accessories

K-7271 Brass Slotted Overflow Bath Drain  
K-9698 Flexjet® Whirlpool Trim Kit

or

K-7272 PVC Slotted Overflow Bath Drain  
K-9698 Flexjet® Whirlpool Trim Kit

### Recommended Accessories

K-1491 Bath/Whirlpool Pillow  
K-1601 Bath/Whirlpool Footstop  
K-1703 Whirlpool Remote Control  
K-592 Under-mount Installation Kit  
K-9497 2-1/2" Keypad Trim  
K-24916 Wireless Music Kit



### Codes/Standards











ASME A112.19.7/CSA B45.10  
CSA B45.5/IAPMO Z124  
ASTM E162  
ASTM E162  
UL 1795  
CSA C22.2 No. 218.2  
Greenguard UL 2818 - Gold  
CARB P2

### KOHLER® One-Year Limited Warranty

See website for detailed warranty information.

### Available Color/Finishes

*Color tiles intended for reference only.*

Color	Code	Description
	0	White
	96	Biscuit
	47	Almond
	NY	Dune
	95	Ice™ Grey
	G9	Sandbar
	33	Mexican Sand™
	K4	Cashmere
	58	Thunder™ Grey
	7	Black Black™

No change in measurements if connected with drain illustrated. (K-7272)

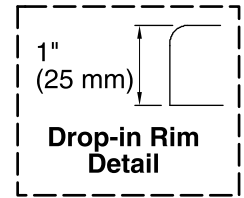
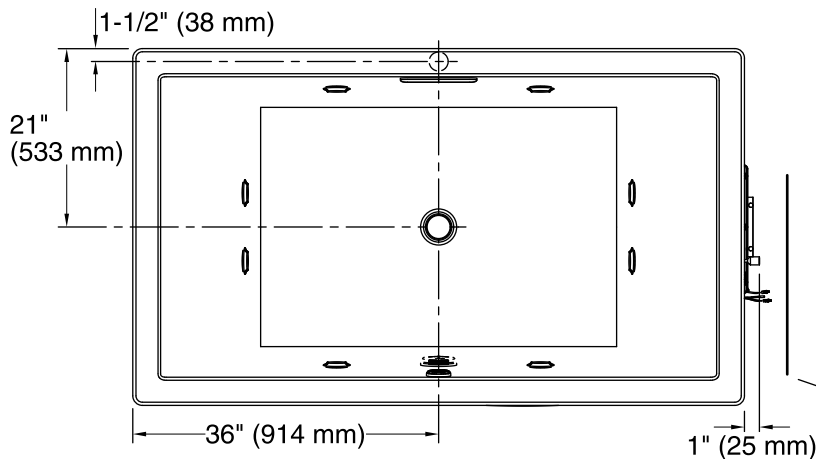

Pump/Control Access  
34" (864 mm) W x 15" (381 mm) H Min

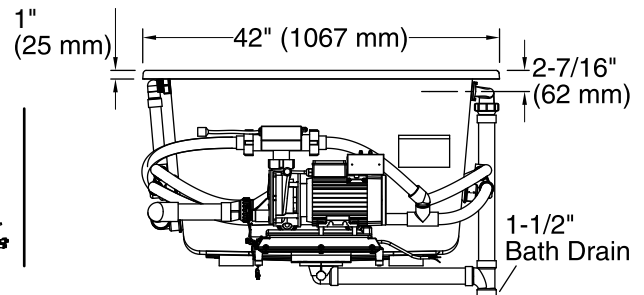
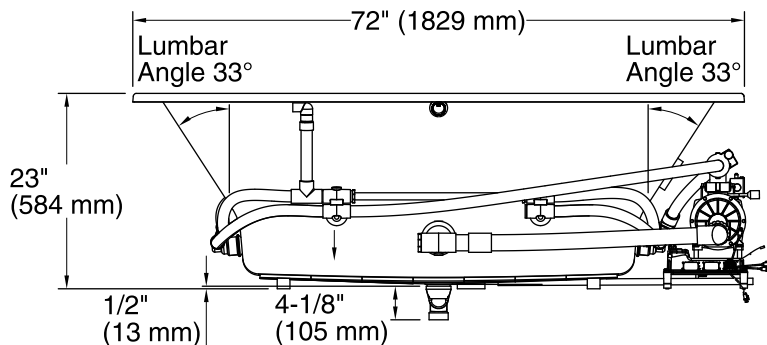

### Required Electrical Service

One dedicated circuit required, protected with Class A Ground-Fault Circuit-Interrupter (GFCI) or Residual Current Device (RCD).

Pump: 240 V, 20 A, 50/60 Hz

### Technical Information

All product dimensions are nominal.

Installation: Drop-in, Under-mount  
 Drain location: Center  
 Basin area, bottom: 45-3/4" x 32" (1162 mm x 813 mm)  
 Basin area, top: 66" x 36" (1676 mm x 914 mm)  
 Weight: 135 lbs (61.2 kg)  
 Minimum floor load: 63 lbs/ft<sup>2</sup> (307.6 kg/m<sup>2</sup>)  
 Water depth: 19" (483 mm)  
 Water capacity: 139 gal (526.2 L)  
 Cutout: Drop-in, 70-1/2" x 40-1/2" (1791 mm x 1029 mm)  
 Electrical component Pump: 240 V, 11 A, 50/60 Hz, 1500 W rating:  
 Minimum flat for door: 2-1/2" (64 mm)

### Notes

Measure your actual product for rough-in details.

Install this product according to the installation instructions.

The hot water supply should be 70% of the capacity of the bath or greater. Installations will vary.