



Features

- End drain.
- Coordinates with other products in the Bancroft collection.
- 66" (1676 mm) x 42" (1067 mm) x 22" (559 mm)

Material

- Acrylic

Hydrotherapy

- 122 BubbleMassage™ airjets. 18 levels of massage intensity.
- Zones of Control feature allows you to target massage to back, midsection, or feet.
- Automatic purge cycles remove residual water from air channels after use.
- Built-in 300 W heater.
- Lighted keypad control.

Installation

- Drop-in

Recommended Accessories

- K-1491 Bath/Whirlpool Pillow
- K-1601 Bath/Whirlpool Footstop
- K-1705 Whirlpool/BubbleMassage™ Remote Control
- K-7161-AF Bath Drain
- K-9498 3" Keypad Trim
- K-24916 Wireless Music Kit
- K-7265 Clearflo Bath Drain
- K-37382 45" Rough-in Cable Bath Drain



Codes/Standards





- ASME A112.19.7/CSA B45.10
- CSA B45.5/IAPMO Z124
- ASTM E162
- ASTM E662
- UL 1795
- Greenguard UL 2818 - Gold

KOHLER® One-Year Limited Warranty

See website for detailed warranty information.

Available Color/Finishes

Color tiles intended for reference only.

Color	Code	Description
	0	White
	96	Biscuit
	47	Almond
	NY	Dune
	G9	Sandbar

No change in measurements if connected with drain illustrated. (K-7161-AF)

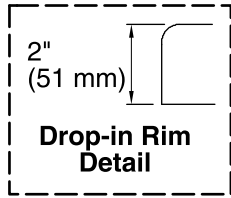

Blower/Control Access
34" (864 mm) W x
15" (381 mm) H Max

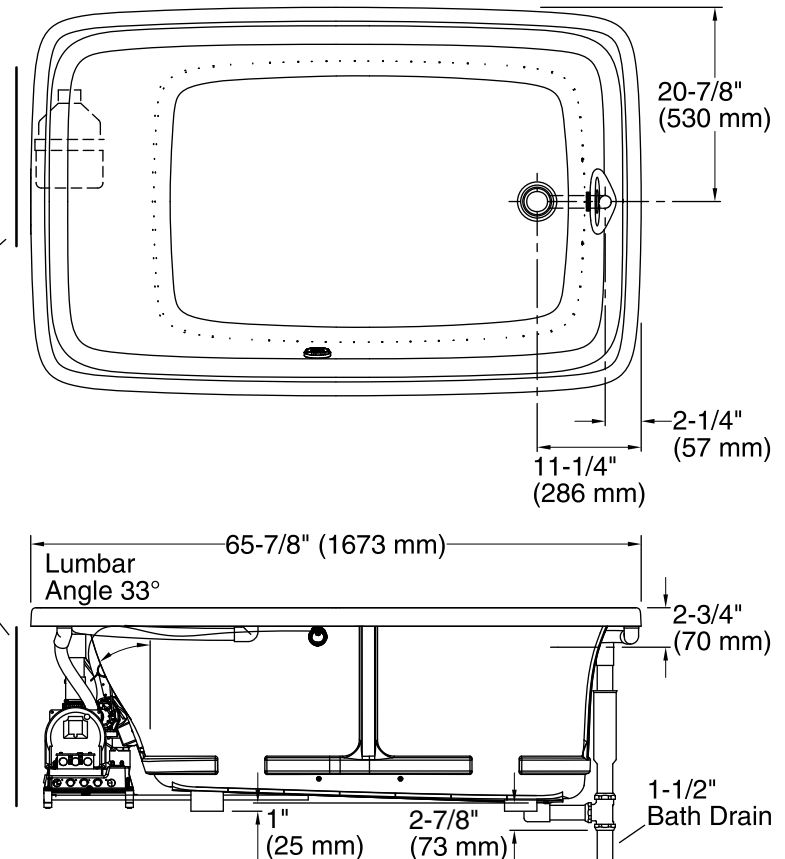
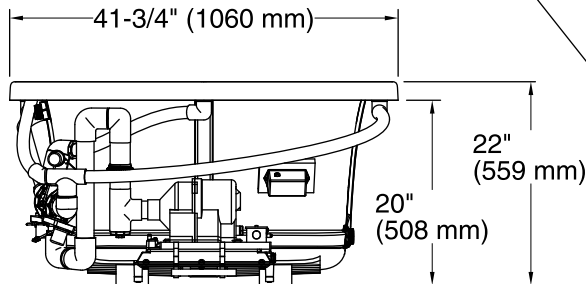

Required Electrical Service

One dedicated circuit required, protected with Class A Ground-Fault Circuit-Interrupter (GFCI) or Residual Current Device (RCD).

Blower: 240 V, 15 A, 50/60 Hz

Technical Information

All product dimensions are nominal.

Installation: Drop-in
 Drain location: End
 Basin area, bottom: 46" x 30" (1168 mm x 762 mm)
 Basin area, top: 57" x 34" (1448 mm x 864 mm)
 Weight: 130 lbs (59 kg)
 Minimum floor load: 50 lbs/ft² (244.1 kg/m²)
 Water depth: 16" (406 mm)
 Water capacity: 95 gal (359.6 L)
 Template: Drop-in, 1043292-7, required, included
 Electrical component rating: Blower: 240 V, 5 A, 50/60 Hz, 300 W
 Blower speed: Variable

Notes

Measure your actual product for rough-in details.

Install this product according to the installation instructions.

The hot water supply should be 70% of the capacity of the bath or greater. Installations will vary.

This bath is designed for drop-in installation only. It is not suited for use in a three wall alcove with an overhead shower.

If relocating the blower motor, do not relocate or alter the PVC tee or coiled flexible tubing connected to the blower. Follow the blower relocation instructions exactly. Provide access for servicing the blower.