

Features

- Traditional styling coordinates with many faucet designs.
- Easy operation with one-touch spray actuation.
- Enhanced ergonomics and maneuverability with balljoint technology.
- MasterClean™ sprayface resists mineral buildup and makes cleanup easy.
- Includes nylon hose and sidespray holder.
- Available in a variety of Kohler finishes, the perfect match.
- Deep rough-in kit available [1030920].

Optional Accessories

1030920 Side Spray Deep Rough-In



ADA

Codes/Standards

ASME A112.18.1/CSA B125.1

NSF 61

NSF 372

All applicable US Federal and State material regulations

ADA







ICC/ANSI A117.1

KOHLER® Faucet Lifetime Limited Warranty

See website for detailed warranty information.

Available Color/Finishes

Color tiles intended for reference only.

Color	Code	Description
	CP	Polished Chrome
	SN	Vibrant® Polished Nickel
	PB	Vibrant® Polished Brass
	G	Brushed Chrome
	BN	Vibrant® Brushed Nickel
	BV	Vibrant® Brushed Bronze
	2BZ	Oil-Rubbed Bronze

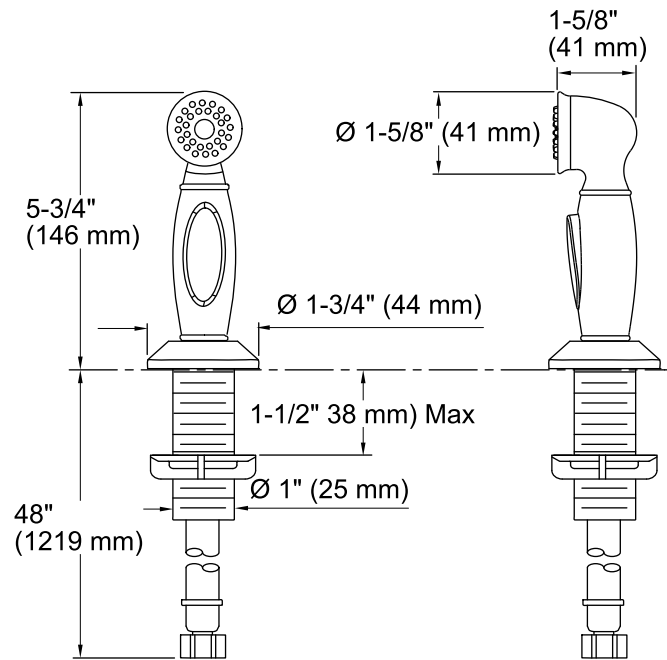
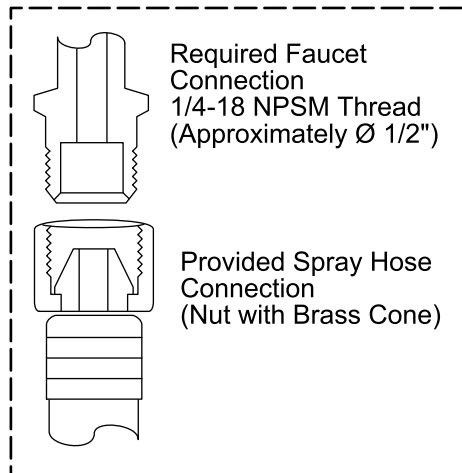

Technical Information

All product dimensions are nominal.

Notes

Install this product according to the installation guide.

ADA compliant when installed to the specific requirements of these regulations.