

Features

- Frameless design emphasizes glass and creates a sleek, minimalist look
- Vertical handle with inside knob on moving panel
- Tempered glass ensures enhanced safety and durability
- CleanCoat®+ glass coating creates a hydrophobic barrier that repels water, soap scum, and residue, saving time and protecting shower doors 10 times longer than original CleanCoat. (Based on 2021 internal wear/abrasion testing using a microfiber cloth.)
- Smooth, easy-to-clean wall jambs
- Full-length moving panel seal provides excellent water containment
- Controlled Close™ innovative soft-close with double-dampening technology eliminates slamming and brings door to a secure close
- Shower door configuration consists of one sliding panel and one stationary panel
- Coordinates with other products in the Rely collection

Material

- Frameless, 3/8" (10 mm) thick Frosted tempered glass with easy-to-clean rectangular grille design imprinted on surface
- Anodized aluminum prevents rust and corrosion

Installation

- Fits opening widths 56-5/8" – 59-5/8" (1438 –1514 mm)
- 77" (1956 mm) high, with a lofty 73-7/8" (1876 mm) minimum head clearance
- 3" (76.2 mm) width adjustment
- Out-of-plumb adjustability simplifies installation
- Door can be installed to open to the left or right to suit your bathroom layout
- For residential use only
- Not for use in hospitality

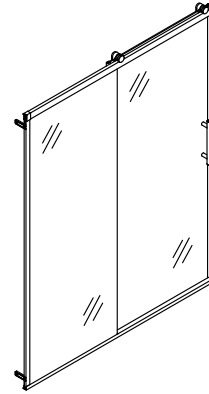

Codes/Standards

ANSI Z97.1
CPSC 16CFR 1201

KOHLER® One-Year Limited Warranty

See website for detailed warranty information.

Available Colors/Finishes

Color tiles intended for reference only.

Color	Code	Description
-------	------	-------------

	BL	Matte Black
---	----	-------------

Available Glass Options

Code	Description
------	-------------

G80	Frosted with Rectangular Grille Pattern
-----	---

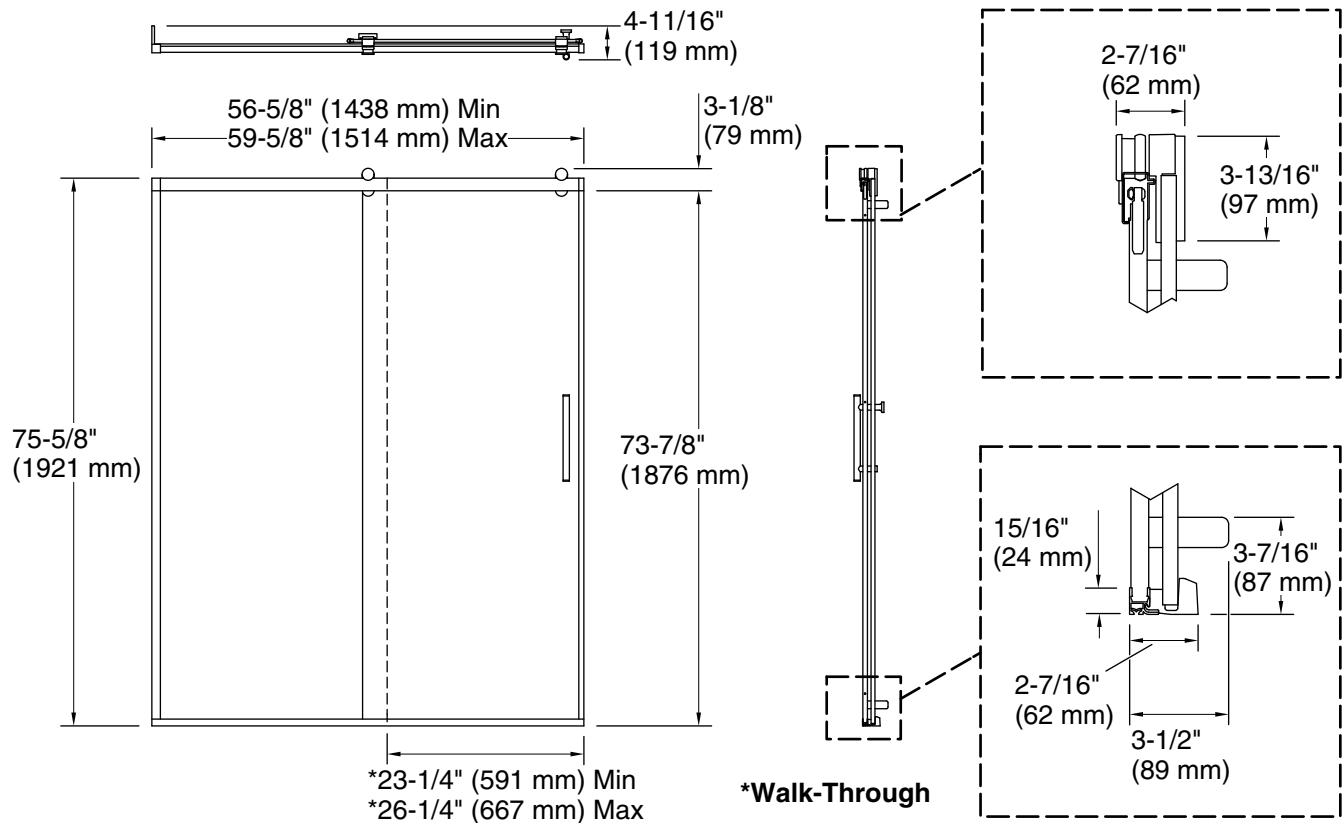

Technical Information

All product dimensions are nominal.

Installation type: For shower base installation

Opening Width - Min: 56-5/8" (1438 mm)

Opening Width - Max: 59-5/8" (1514 mm)

Walk-through - Min: 23-1/4" (591 mm)

Walk-through - Max: 26-1/4" (667 mm)

Base-To-Wall Radius - Max: 1/2" (13 mm)

Glass thickness: 3/8" (10 mm)

Glass coating: CleanCoat+

Notes

Install this product according to the installation guide.

The vertical opening should be a minimum of 78-1/2" (1994 mm) to allow for installation clearance.