

Features

- Clean, crisp lines blend into soft angles to create a uniquely sophisticated bath that works with any decor
- Integral lumbar support
- Integral apron creates a clean, finished look
- Integral flange helps prevent water from seeping behind wall and simplifies alcove installation

Material

- Acrylic

Installation

- Alcove
- Right drain

Recommended Products/Accessories

- K-7213 27" Cable Bath Drain
- K-7259 Brass toe tap bath drain



Codes/Standards







- CSA B45.5/IAPMO Z124
- ASTM E162
- ASTM E662

KOHLER® Plastic Baths and Shower Bases Lifetime Limited Warranty

See website for detailed warranty information.

Available Colors/Finishes

Color tiles intended for reference only.

Color	Code	Description
	0	White
	96	Biscuit
	NY	Dune
	95	Ice™ Grey
	58	Thunder™ Grey
	7	Black Black™

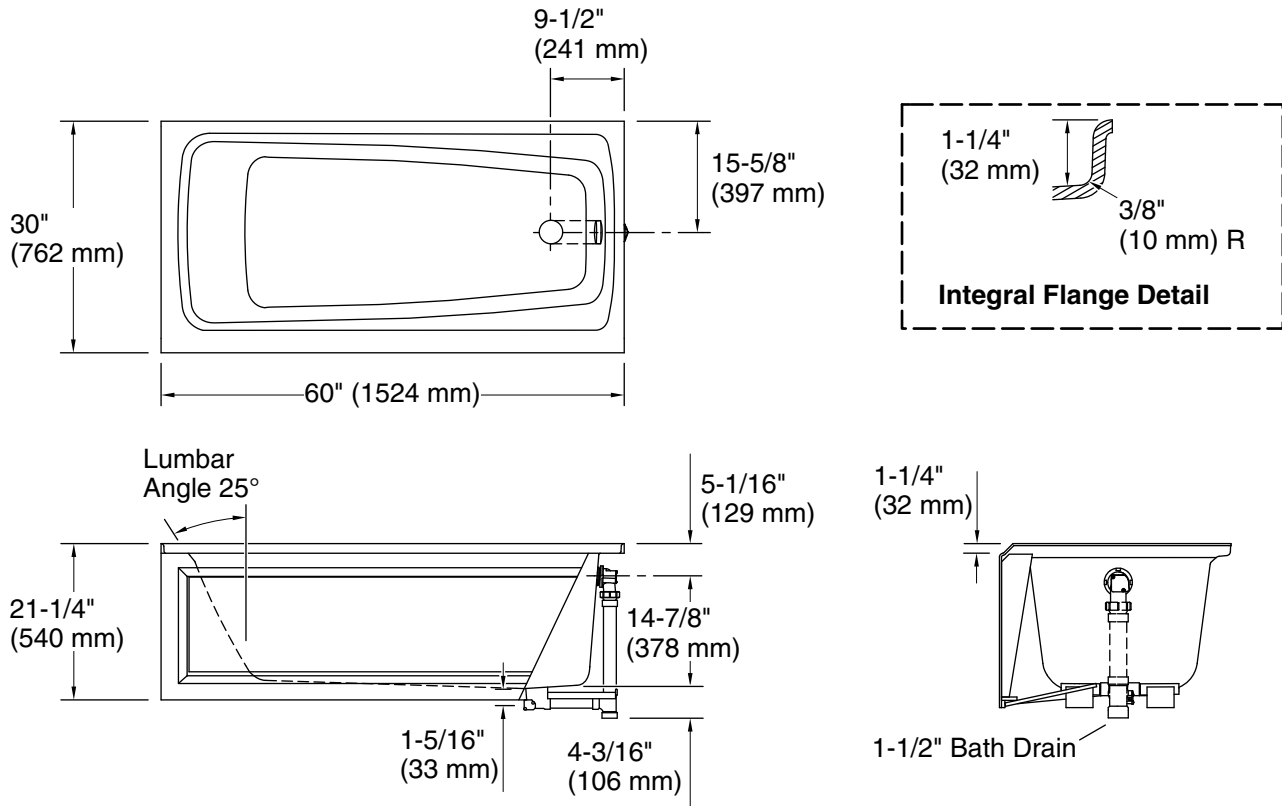

Technical Information

All product dimensions are nominal.

Installation:	Three-wall alcove
Drain location:	Right
Weight:	67 lbs (30.4 kg)
Minimum floor load:	40.7 lbs/ft ² (198.7 kg/m ²)
Water depth:	14-7/8" (377 mm)
Water capacity:	50 gal (189.3 L)
Minimum flat for door:	2-1/8" (55 mm)

Notes

Measure your actual product for rough-in details.

Install this product according to the installation instructions.

The hot water supply should be 70% of the capacity of the bath or greater. Installations will vary.