

Features

- 60-inch hose length.
- Swivel base helps reach target areas.
- For use with a handshower (sold separately).
- KOHLER finishes resist corrosion and tarnishing.

Material

- Durable metal construction.



Codes/Standards













None Applicable

KOHLER® Faucet Lifetime Limited Warranty

See website for detailed warranty information.

Available Color/Finishes

Color tiles intended for reference only.

Color	Code	Description
	CP	Polished Chrome
	SN	Vibrant® Polished Nickel
	AF	Vibrant® French Gold
	PB	Vibrant® Polished Brass
	BGD	Vibrant® Moderne Brushed Gold
	G	Brushed Chrome
	BN	Vibrant® Brushed Nickel
	BV	Vibrant® Brushed Bronze
	2BZ	Oil-Rubbed Bronze
	BL	Matte Black
	RGD	Vibrant Rose Gold
	TT	Titanium
	VNT	Vintage Nickel

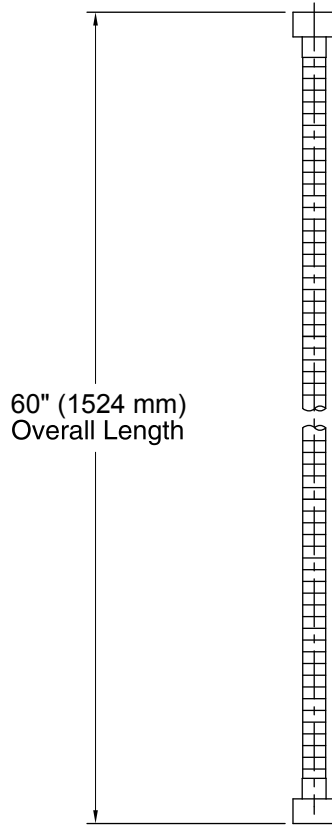

Technical Information

All product dimensions are nominal.

Notes

Install this product according to the installation guide.

Features

- Air-induction technology maximizes the air/water mix for a powerful, even flow.
- Optimized sprayface with 48 nozzles delivers a more focused coverage.
- Ergonomic sprayhead pivots to allow precise adjustment for targeted hydromassage.
- MasterClean™ sprayface is easy to clean.
- 2.0 gal/min (7.6 l/min) maximum flow rate.
- Requires K-8593 or K-9514 shower hose (sold separately).
- Coordinates with other products in the Artifacts collection.

Installation

- Bracket or sidebar required for wall-mount installation.
- Deck-mount holder required for deck-mount installation.

Water Conservation & Rebates

- WaterSense®-labeled 2.0-gpm handshowers use up to 20 percent less water than standard 2.5-gpm handshowers, while still meeting strict performance guidelines.
- This product can help a building earn Water Efficiency points in the LEED® Green Building Rating System.

Required Accessories

- K-8593 72" Shower Hose
- K-9514 60" Shower Hose



Codes/Standards

ASME A112.18.1/CSA B125.1
DOE - Energy Policy Act 1992
EPA WaterSense®
California Energy Commission (CEC)

KOHLER® Faucet Lifetime Limited Warranty

See website for detailed warranty information.

Available Color/Finishes

Color tiles intended for reference only.

Color	Code	Description
	CP	Polished Chrome
	SN	Vibrant® Polished Nickel
	BN	Vibrant® Brushed Nickel
	BV	Vibrant® Brushed Bronze
	2BZ	Oil-Rubbed Bronze
	VNT	Vintage Nickel

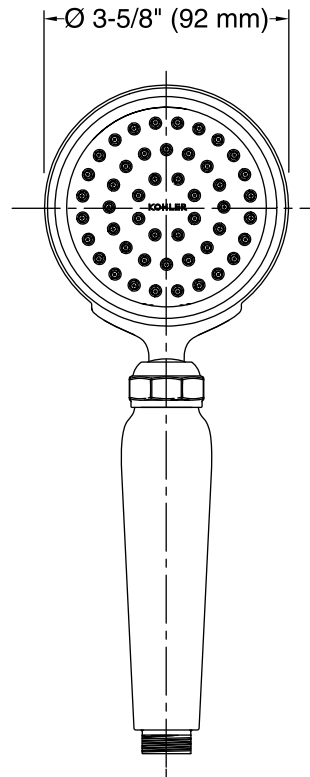
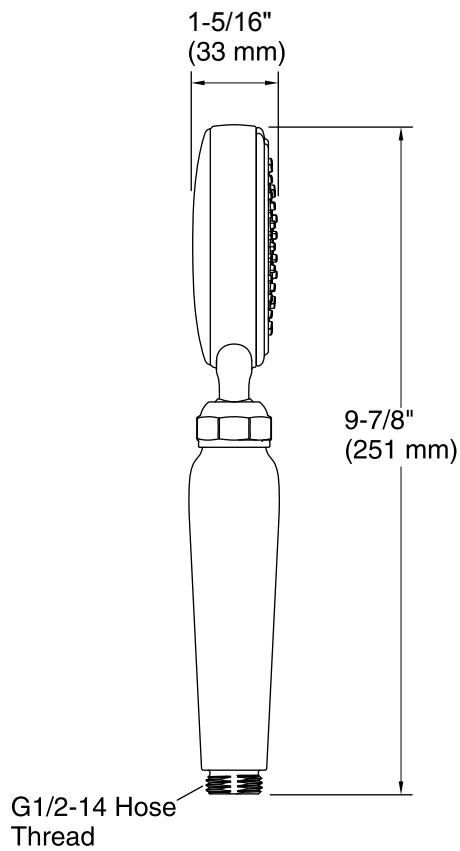

Technical Information

All product dimensions are nominal.

Handshower:

Rated maximum flow: 2 gal/min (7.6 l/min)

Notes

Install this product according to the installation guide.

Plumbing codes require an atmospheric vacuum breaker (such as Kohler Model K-9660) be installed in-line with handshowers. Please consult with local plumbing officials.



Features

- Metal construction
- For use with a handshower and hose
- Includes check valve for backflow prevention
- Coordinates with Artifacts™ faucets and accessories

WALL-MOUNT SUPPLY ELBOW K-72796

Codes/Standards Applicable

Specified model meets or exceeds the following:

- ASME A112.18.1/CSA B125.1

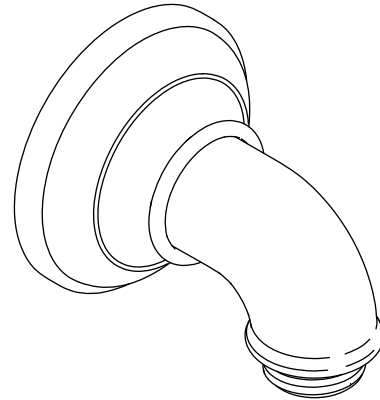

Colors/Finishes

- CP: Polished Chrome
- Other: Refer to Price Book for additional colors/finishes

Specified Model

Model	Description	Colors/Finishes	
K-72796	Wall-mount supply elbow	<input type="checkbox"/> CP	<input type="checkbox"/> Other_____

Product Specification

Supply elbow shall be made of metal construction. Product shall be for use with a handshower and hose. Product shall include check valve for backflow prevention. Product shall coordinate with Artifacts faucets and accessories. Supply elbow shall be Kohler Model K-72796-_____.

Installation Notes

Install this product according to the installation guide.

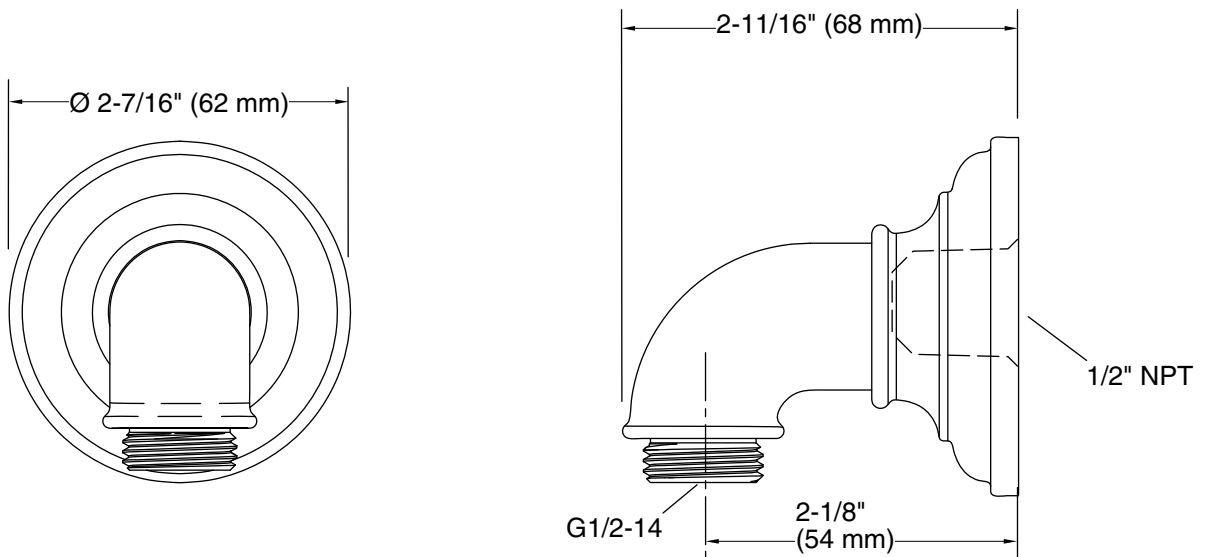

Product Diagram

Features

- Allows handshower to be raised or lowered to desired height for customized showering experience.
- Handshower not included.
- Coordinates with other products in the Artifacts™ collection.
- 3-3/16" (81 mm) x 2-1/2" (64 mm) x 30" (762 mm)

Material

- Premium metal construction.
- KOHLER finishes resist corrosion and tarnish.

Installation

- Wall-mount.



ADA CSA B651 OBC

Codes/Standards



ASME A112.18.1/CSA B125.1
ADA
ICC/ANSI A117.1
CSA B651
OBC

KOHLER® Faucet Lifetime Limited Warranty

See website for detailed warranty information.

Available Color/Finishes

Color tiles intended for reference only.

Color	Code	Description
	CP	Polished Chrome
	SN	Vibrant® Polished Nickel
	BN	Vibrant® Brushed Nickel
	BV	Vibrant® Brushed Bronze
	2BZ	Oil-Rubbed Bronze
	VNT	Vintage Nickel

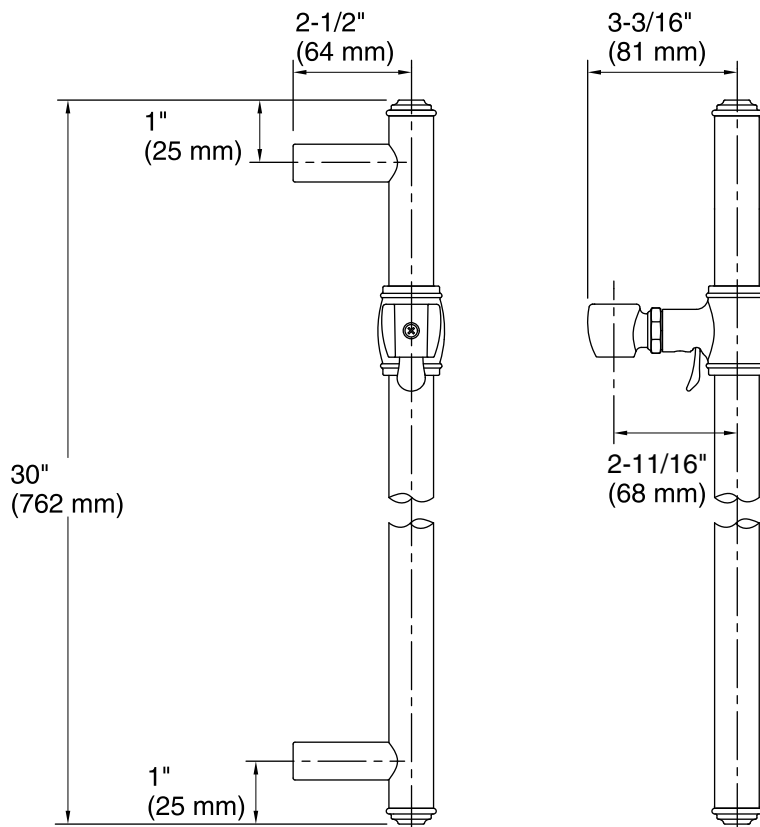

Technical Information

All product dimensions are nominal.

Notes

Install this product according to the installation guide.

ADA, OBC, CSA B651 compliant when installed to the specific requirements of these regulations.

Features

- For use with K-72798 Artifacts slidebar.
- Set of two.
- 1" (25 mm) x 2-1/4" (57 mm)

Material

- Premium metal construction.
- KOHLER finishes resist corrosion and tarnish.

Required Accessories

K-72798 Shower Slidebar



Codes/Standards

None Applicable

KOHLER® Faucet Lifetime Limited Warranty

See website for detailed warranty information.

Available Color/Finishes

Color tiles intended for reference only.

Color	Code	Description
	CP	Polished Chrome
	SN	Vibrant® Polished Nickel
	BN	Vibrant® Brushed Nickel
	BV	Vibrant® Brushed Bronze
	2BZ	Oil-Rubbed Bronze
	VNT	Vintage Nickel

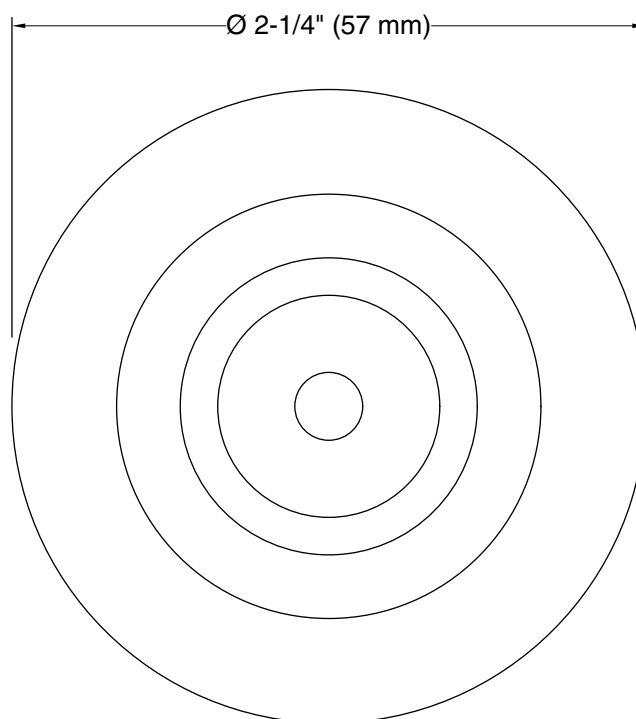
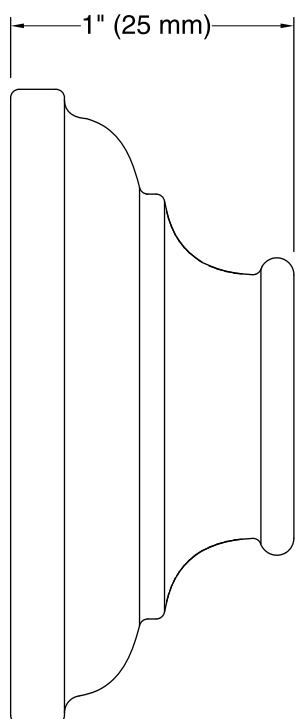

Technical Information

All product dimensions are nominal.

Notes

Install this product according to the installation guide.