

### Features

- 30" adjustable slidebar supports a handshower at the desired height for a customized showering experience.

### Material

- Durable metal construction.
- KOHLER finishes resist corrosion and tarnishing.



ADA CSA B651

### Codes/Standards

ASME A112.18.1/CSA B125.1  
ADA  
ICC/ANSI A117.1  
CSA B651

### KOHLER® Faucet Lifetime Limited Warranty

See website for detailed warranty information.

### Available Color/Finishes

*Color tiles intended for reference only.*

Color	Code	Description
	CP	Polished Chrome
	SN	Vibrant® Polished Nickel
	AF	Vibrant® French Gold
	PB	Vibrant® Polished Brass
	BGD	Vibrant® Moderne Brushed Gold
	G	Brushed Chrome
	BN	Vibrant® Brushed Nickel
	BV	Vibrant® Brushed Bronze
	2BZ	Oil-Rubbed Bronze
	BL	Matte Black
	RGD	Vibrant Rose Gold
	TT	Titanium

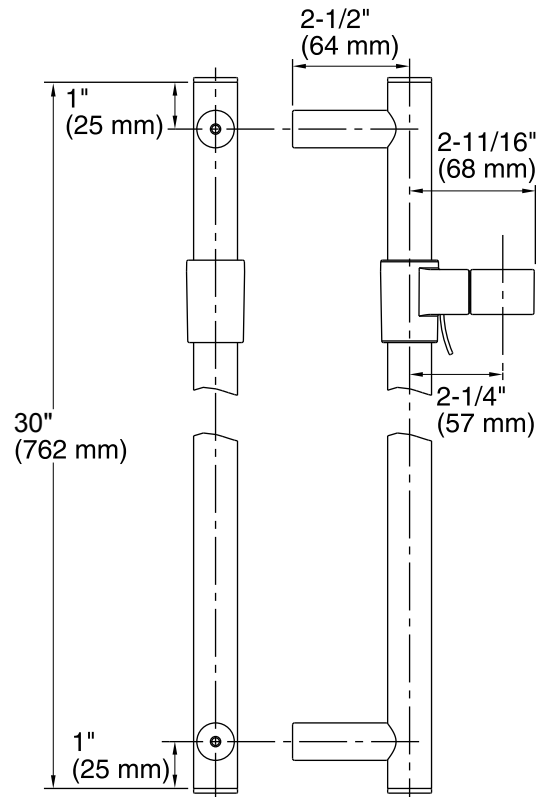

### Technical Information

All product dimensions are nominal.

### Notes

Install this product according to the installation guide.

ADA, CSA B651 compliant when installed to the specific requirements of these regulations.

#### Features

- 60-inch hose length.
- Swivel base helps reach target areas.
- For use with a handshower (sold separately).
- KOHLER finishes resist corrosion and tarnishing.

#### Material

- Durable metal construction.



#### Codes/Standards













None Applicable

#### KOHLER® Faucet Lifetime Limited Warranty

See website for detailed warranty information.

#### Available Color/Finishes

*Color tiles intended for reference only.*

Color	Code	Description
	CP	Polished Chrome
	SN	Vibrant® Polished Nickel
	AF	Vibrant® French Gold
	PB	Vibrant® Polished Brass
	BGD	Vibrant® Moderne Brushed Gold
	G	Brushed Chrome
	BN	Vibrant® Brushed Nickel
	BV	Vibrant® Brushed Bronze
	2BZ	Oil-Rubbed Bronze
	BL	Matte Black
	RGD	Vibrant Rose Gold
	TT	Titanium
	VNT	Vintage Nickel

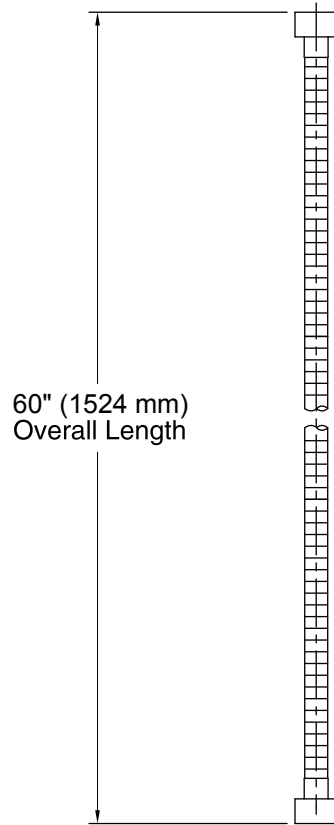

**Technical Information**

All product dimensions are nominal.

**Notes**

Install this product according to the installation guide.

#### Features

- Advanced spray engine provides three experiences: full coverage, pulsating massage and silk spray.
- Full coverage spray produces an encompassing spray for everyday use and utilizes Katalyst® air induction to create large, full drops.
- Pulsating massage spray targets sore muscles to ease away aches and pains.
- Silk spray releases a dense, luxurious spray ideal for rinsing.
- Thumb tab allows for a smooth transition between sprays.
- Combination of balance, weight, grip, and angle makes this handshower comfortable and easy to use.
- MasterClean™ spray nozzles prohibit mineral buildup for easy cleaning.
- Thumb tab allows for a smooth transition between sprays.
- 2.5 gpm (gallons per minute) flow rate.
- Requires K-8593, K-9514, K-98360, K-98359, K-45981 or K-45982 shower hose (sold separately).
- Coordinates with Bancroft® and Devonshire® faucets and accessories.

#### Material

- KOHLER finishes resist corrosion and tarnishing.

#### Installation

- Bracket or sidebar required for wall-mount installation.
- Deck-mount holder required for deck-mount installation.

#### Required Products/Accessories

K-8593 72" Shower Hose

or

K-9514 60" Shower Hose

or

K-98360 72" Smooth Shower Hose

or

K-98359 60" Smooth Shower Hose

or

K-45981 72" ribbon hose

or

K-45982 60" ribbon hose



ADA CSA B651 OBC

#### Codes/Standards







ASME A112.18.1/CSA B125.1  
DOE - Energy Policy Act 1992  
ADA  
ICC/ANSI A117.1  
CSA B651  
OBC

#### KOHLER® Faucet Lifetime Limited Warranty

See website for detailed warranty information.

#### Available Colors/Finishes

*Color tiles intended for reference only.*

Color	Code	Description
	CP	Polished Chrome
	SN	Vibrant® Polished Nickel
	PB	Vibrant® Polished Brass
	BN	Vibrant® Brushed Nickel
	BV	Vibrant® Brushed Bronze
	2BZ	Oil-Rubbed Bronze

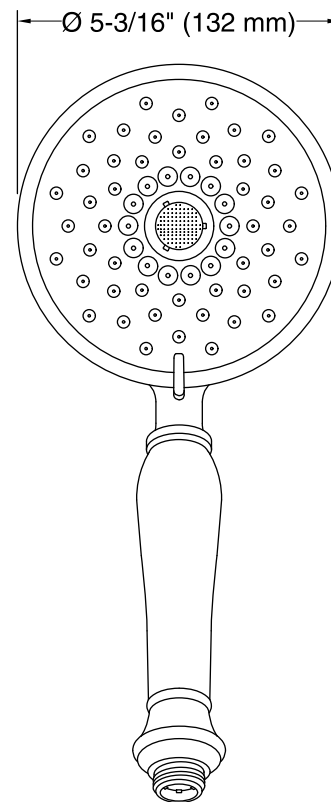
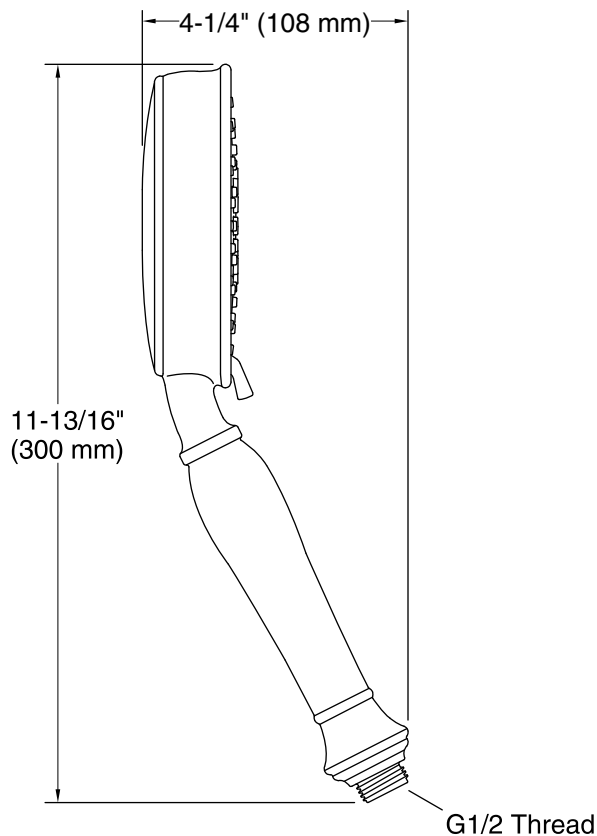

#### Technical Information

All product dimensions are nominal.

#### Handshower:

Rated maximum flow: 2.5 gal/min (9.5 l/min)

#### Notes

Install this product according to the installation instructions.

Plumbing codes require an atmospheric vacuum breaker (such as Kohler Model K-9660) be installed in-line with handshowers. Please consult with local plumbing officials.

ADA, OBC, CSA B651 compliant when installed to the specific requirements of these regulations.

#### Features

- For use with a handshower and hose (sold separately).
- Includes check valve for backflow prevention.
- Coordinates with Bancroft and Devonshire faucets and accessories.

#### Material

- Brass construction.
- KOHLER finishes resist corrosion and tarnishing.

#### Installation

- Wall-mount.



#### Codes/Standards







None Applicable

#### KOHLER® Faucet Lifetime Limited Warranty

See website for detailed warranty information.

#### Available Colors/Finishes

*Color tiles intended for reference only.*

Color	Code	Description
	CP	Polished Chrome
	SN	Vibrant® Polished Nickel
	PB	Vibrant® Polished Brass
	BN	Vibrant® Brushed Nickel
	BV	Vibrant® Brushed Bronze
	2BZ	Oil-Rubbed Bronze

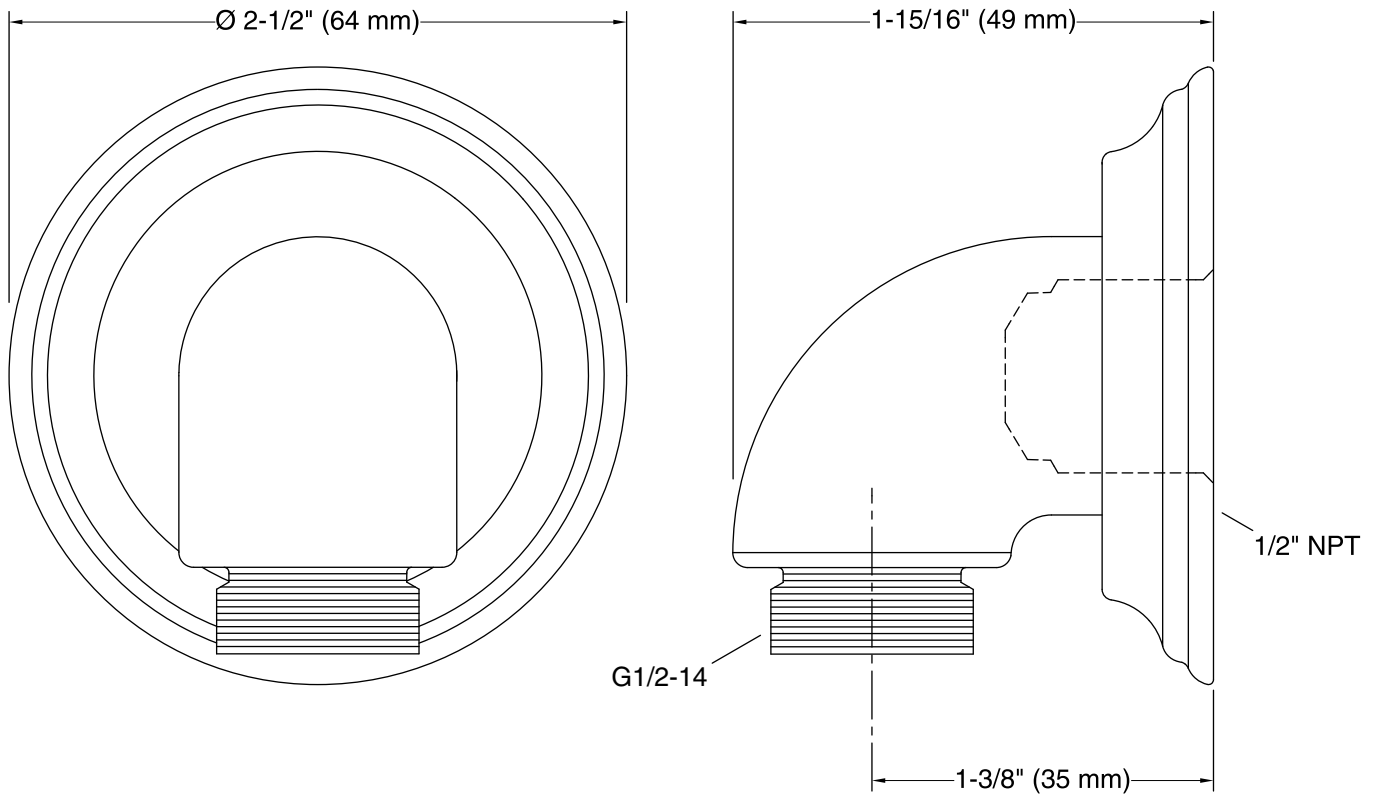

**Technical Information**

All product dimensions are nominal.

**Notes**

Install this product according to the installation instructions.



### Features

- KOHLER finishes resist corrosion and tarnishing.
- For use with the K-8524 and K-9069 slidebars.
- Coordinates with Forte and Bancroft faucets and accessories.

### Material

- Durable metal construction.



### Codes/Standards









ASME A112.18.1/CSA B125.1

### KOHLER® Faucet Lifetime Limited Warranty

See website for detailed warranty information.

### Available Color/Finishes

*Color tiles intended for reference only.*

Color	Code	Description
	CP	Polished Chrome
	SN	Vibrant® Polished Nickel
	AF	Vibrant® French Gold
	PB	Vibrant® Polished Brass
	G	Brushed Chrome
	BN	Vibrant® Brushed Nickel
	BV	Vibrant® Brushed Bronze
	2BZ	Oil-Rubbed Bronze
	BKB	Brushed Black

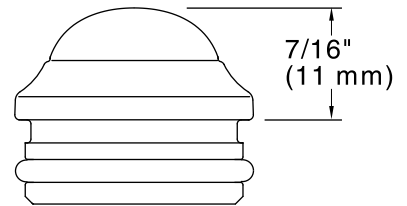
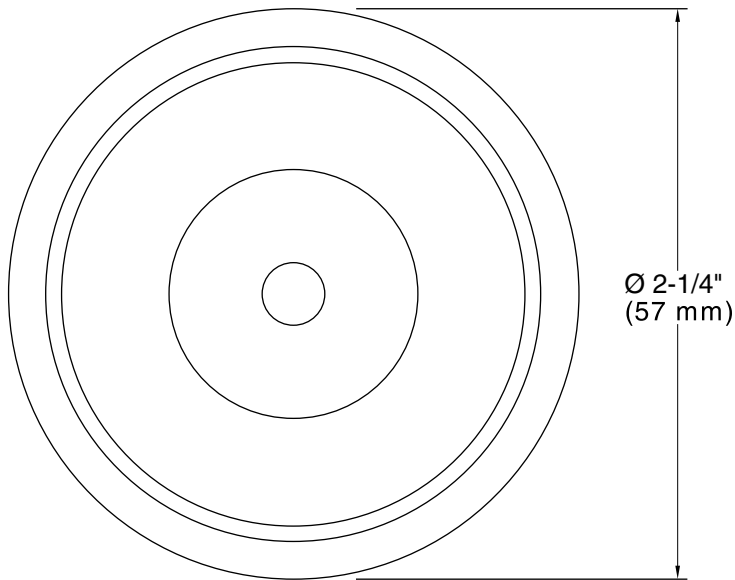
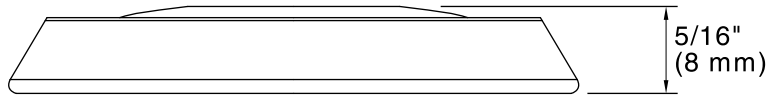

**Technical Information**

All product dimensions are nominal.

**Notes**

Install this product according to the installation guide.