

#### Features

- Obround/capsule shaped basin
- With overflow
- No faucet holes; requires wall- or counter-mount faucet

#### Material

- KOHLER® enameled cast iron.

#### Installation

- Vessel, drop-in, or under-mount



ADA CSA B651

#### Codes/Standards











ASME A112.19.1/CSA B45.2  
 ADA  
 ICC/ANSI A117.1  
 CSA B651

#### Lifetime Limited Warranty for KOHLER® Cast Iron Components

See website for detailed warranty information.

#### Available Color/Finishes

*Color tiles intended for reference only.*

Color	Code	Description
	0	White
	FF	Sea Salt™
	96	Biscuit
	FD	Cane Sugar™
	NY	Dune
	G9	Sandbar
	K4	Cashmere
	FT	Basalt
	KA	Black 'n Tan
	7	Black Black™

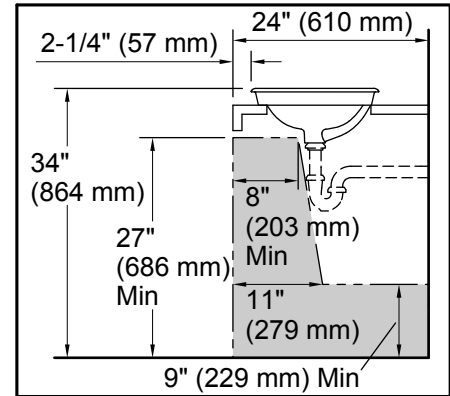
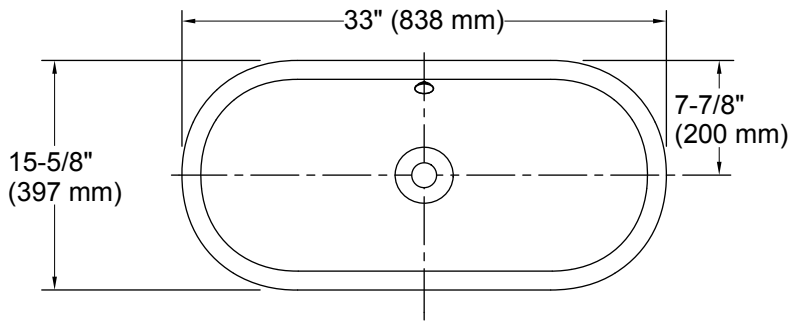

**Recommended ADA Installation**

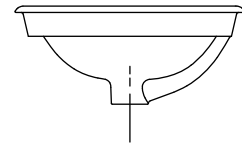
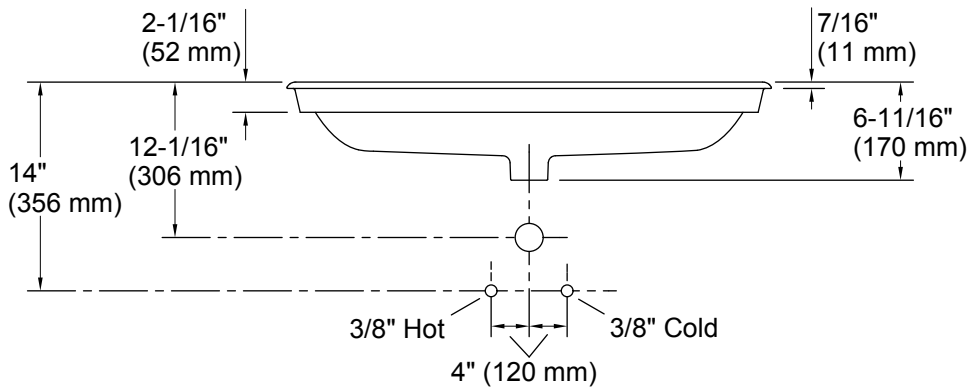

### Technical Information

All product dimensions are nominal.

Installation: Drop-In, Under-mount, Vessel

Drain hole: 1-3/4" (44 mm)

Template: 1319049-7, required, included

### Notes

Install this product according to the installation instructions.

**NOTICE:** Countertop manufacturer or cutter must use the cut-out template provided with the product, or a current one provided by Kohler Co. (call 1-800-4-KOHLER). Kohler Co. is not responsible for cutout errors when the incorrect cut-out template is used.

ADA, CSA B651 compliant when installed to the specific requirements of these regulations.