



## Features

- Low-threshold design for easy entry and exit.
- Molded-in textured floor.
- Water containment bead incorporated into the threshold design provides an optimum barrier, eliminating water escaping from the shower space.
- Single threshold for alcove installation.
- Durable acrylic construction.
- Left-hand drain.
- Coordinates with Choreograph® shower walls and other KOHLER collections.

## Recommended Accessories

K-9132 Shower Drain



## Codes/Standards







CSA B45.5/IAPMO Z124  
ASTM E162  
ASTM E662  
Greenguard UL 2818 - Gold

## KOHLER® Plastic Baths and Receptors Lifetime Limited Warranty

See website for detailed warranty information.

## Available Color/Finishes

*Color tiles intended for reference only.*

Color	Code	Description
	0	White
	96	Biscuit
	47	Almond
	NY	Dune
	95	Ice™ Grey
	G9	Sandbar

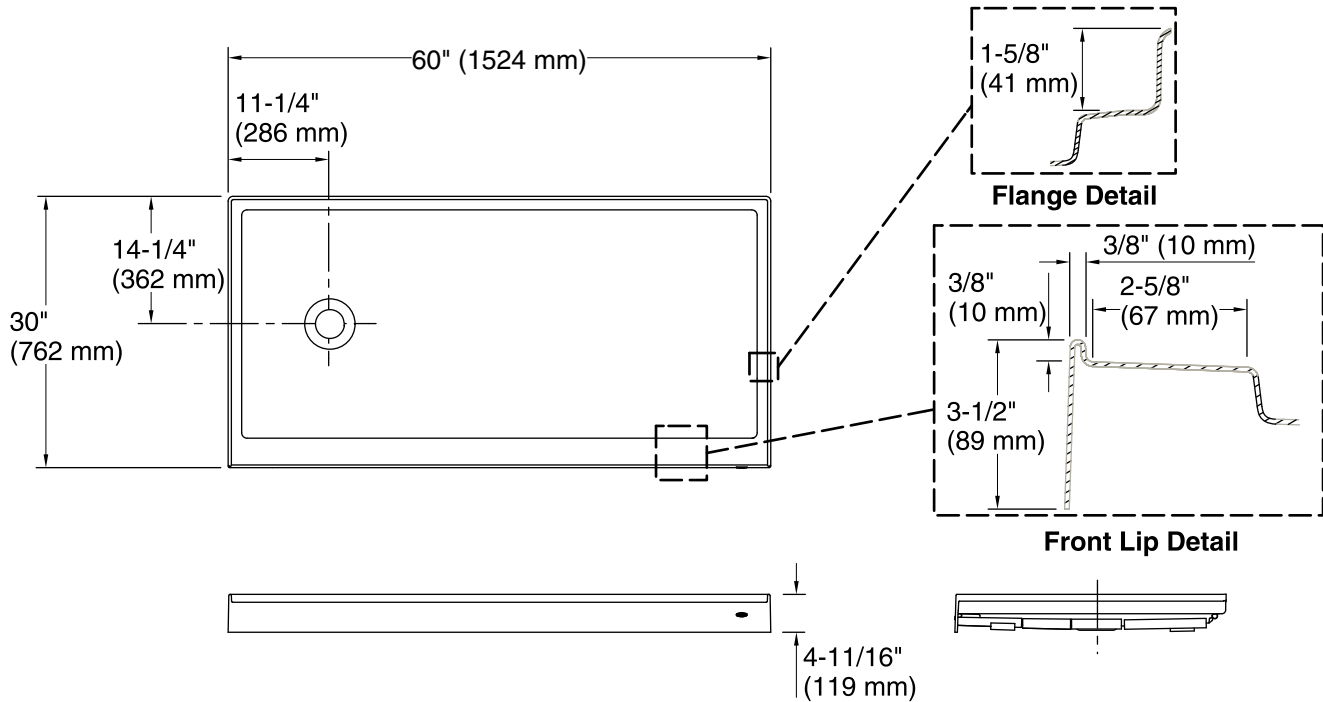

## Technical Information

All product dimensions are nominal.

Installation: 3-Wall Alcove

Drain location: Left

Weight: 59 lbs (26.8 kg)

## Notes

Measure your actual product for rough-in details.

Install this product according to the installation instructions.

Subfloor must be within 1/2" (13 mm) of level.

This receptor has a front lip. This should be taken into account when installing a shower door.