

MEDALLION GOURMET SERIES

Undermount Gourmet Single Bowl Model MGS-3018



MGS-3018

FEATURES

- Premium grade T-304 stainless steel
- 9" depth • 18 gauge
- StoneGuard™ undercoating over Super-Silencer pad
- SpecPlus™ edge
- Lustrous satin with highlighted rim
- Fits 36" sink base • 3-1/2" drain opening
- Supplied with cutout template, fasteners and instructions
- Complies with ASME A112.19.3-2000, cUPC®
- Lifetime Limited Warranty



ASME A112.19.3-2000

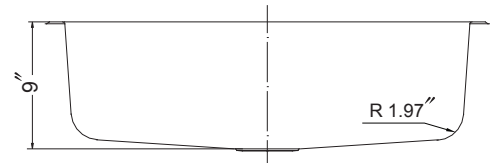
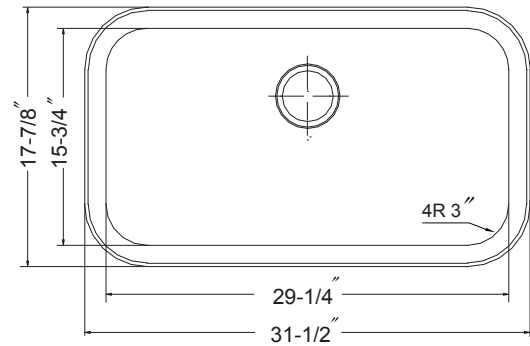

OPTIONAL ACCESSORIES

Bottom Grid: BG-3600

Cutting Board : CB-2500

Strainer: 190-9180

OVERALL DIMENSIONS	EACH BOWL	CUTOUT SIZE	PACKAGING*	WEIGHT*
31-1/2" x 17-7/8"	29-1/4" x 15-3/4"	See Template	1/16/20 pcs.	21/370/040 lbs.

*Standard packaging: Single boxed /Pallet of single boxed/Pallet of bulk pack.
All dimensions are in inches. Specifications subject to change without notice.

Project/Job name

Architect/Engineer

Contractor

Model Q'ty

Notes

Installation profile

